

RADIO-CRAFT

HUGO GERNSBACK, *Editor*

**MAYOR LA GUARDIA'S
DESK RADIO**

See Page 202

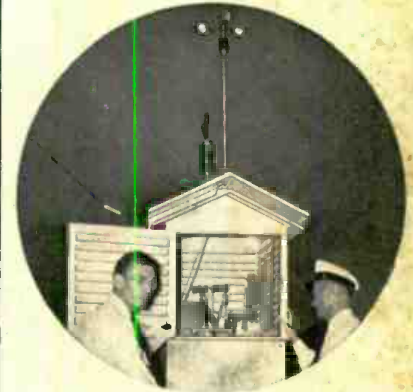

WEATHER ROBOT

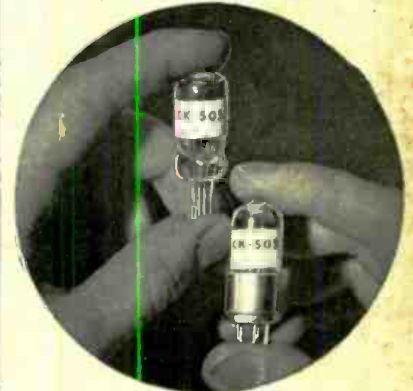

5/8-VOLT TUBES!

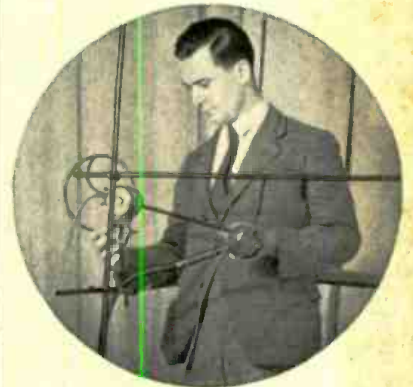

MIKE TESTING

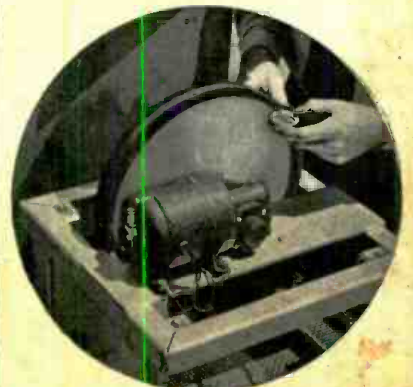

FULCHRONOGRAPH!

OCT. 25c RADIO'S GREATEST MAGAZINE
CANADA 30c MODEL SERVICE SHOP • MINIATURE-TUBE AUDIO AMPLIFIER
NEW MINIATURE PORTABLES • THE GROUND & INTERFERENCE

Order your copy NOW—the only

P. A. HANDBOOK

**NOW READY
FOR DELIVERY**

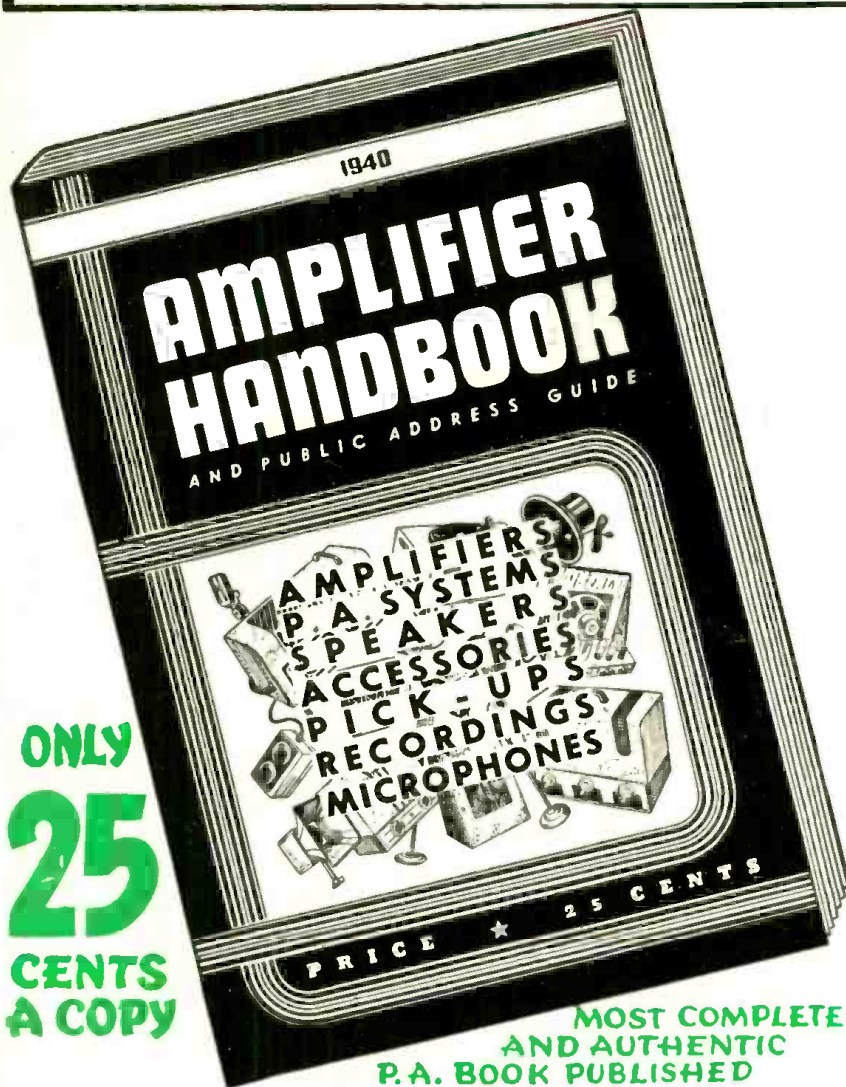

**ONLY
25
CENTS
A COPY**

THAT no book has yet been published which covers amplifiers and sound systems (also kindred systems) in one complete, authentic volume is almost unbelievable. Yet, it is a fact, there is no book in print which covers Public Address from A to Z. To bridge this wide-spread gap, RADIODRAFT will publish a complete, magnificent volume on Public Address of such magnitude—so complete and authoritative—that every man engaged in radio can have both a theoretical and practical knowledge of the function and operation of sound systems. The editorial pages are so filled with instruction and replete with illustrations that the volume fully justifies its title of 1940 AMPLIFIER HANDBOOK AND PUBLIC ADDRESS GUIDE. This great HANDBOOK on Public Address should be read and studied by those who consistently build, service and sell sound equipment.

A MATCHLESS VOLUME
As complete as you would expect to find any engineering handbook—this is how the radio or P. A. man finds the AMPLIFIER HANDBOOK AND PUBLIC ADDRESS GUIDE. With essential technical data compiled from an exceptionally large number of sources, the volume covers nearly a hundred different subjects coordinating every conceivable branch or sub-division of Public Address.

THE CONTENTS
To actually show the scope and magnitude of the AMPLIFIER HANDBOOK AND PUBLIC ADDRESS GUIDE, an analysis of the contents is found at the right, showing the breakdown of the material featured within each particular section. A thorough reading of the contents shows the completeness of this book.

**A Resume of the Contents of the
AMPLIFIER HANDBOOK
AND PUBLIC ADDRESS GUIDE**

FOREWORD

INTRODUCTION

Definitions—decibels, frequency, input, output, impedance, etc.

SECTION I—SOURCE

Carbon microphones (single-button and double-button)
Condenser microphones
Velocity (ribbon) microphones
Dynamic microphones
Crystal microphones (sound-cell types, crystal diaphragm types)
Cardioid microphones
Contact microphones
Phonograph pickups (magnetic types, crystal types)

SECTION II—AMPLIFIERS

Voltage Amplification
Design of resistance-coupled voltage amplifiers
Commercial voltage amplifier
The Power Stage
Class A amplifiers
Class AB amplifiers
Class AB₁ amplifiers
Class AB₂ amplifiers
Class B amplifiers
When to apply class A, AB, and B amplification

Power Supplies
Half-wave rectification
Full-wave rectification
Voltage doublers

Filter Circuits
Power supply regulation, etc.
Practical Hints on Amplifier Construction

Microphonism
Placement of components
Tone compensation
Inverse feedback
Remote control methods

SECTION III—DISTRIBUTION

The Loudspeaker
Dynamic speakers
Speaker performance (frequency response, efficiency)
High-fidelity speakers
Speaker Baffles and Housings
Outdoor speaker installations
Power cone speakers
Radial (360° distribution) speaker baffles

SECTION IV—COORDINATION

Input impedance matching
Matching speakers to P. A. installations
Phasing speakers
Effect of mismatching speakers to amplifier output
A typical P. A. installation (in a skating rink)

SECTION V—USEFUL PUBLIC ADDRESS DATA AND INFORMATION

Speaker matching technique
The ABC of Db., VU, Mu, Gm and Sm
Charts and formulas useful to the practical P. A. sound man
Handy index to important articles on public address and sound

RADCRAFT PUBLICATIONS ■ 20 VESEY STREET ■ NEW YORK, N. Y.

RADCRAFT PUBLICATIONS, INC. ★ 20 VESEY STREET ★ NEW YORK, N. Y. RC-1040
Gentlemen: Enclosed find my remittance of 25c for which send me POSTPAID, one copy of your NEW—1940 AMPLIFIER HANDBOOK AND PUBLIC ADDRESS GUIDE.

Send me others, for friends, also POSTPAID @ 25c each.

Name Address

City State

Remit by check or money order; register letter if you send cash or unused U.S. Postage Stamps.

Order Your Copy NOW—

*Clip Coupon and
Mail Today!*

MAILING THIS COUPON
has started hundreds
on the way to
BETTER PAY
IN RADIO

You Can Train at Home for Radio and Television

Clip the coupon and mail it. I want you to see how I train ambitious men at home in spare time to be Radio Technicians. I will send you a sample lesson Free. Examine it, read it, see how clear and easy it is to understand. See how my Course is planned to help you get a good job in Radio, a young, growing field with a future. You needn't give up your present job, or spend a lot of money to become a Radio Technician. I train you at home in your spare time.

Jobs Like These Go to Men Who Know Radio

Radio broadcasting stations employ many operators, technicians and pay well for trained men. Radio manufacturers employ testers, inspectors, servicemen in good-pay jobs with opportunities for advancement. Radio jobbers and dealers employ installation and servicemen. Many Radio Technicians open their own Radio sales and repair business and make \$30, \$40, \$50 a week. Others hold their regular jobs and make \$5 to \$10 a week fixing Radios in spare time. Automobile, police, aviation, commercial Radio; loudspeaker systems, electronic devices, are newer fields offering good opportunities to qualified men. And my Course includes Television, which promises to open many good jobs soon.

Many Make \$5 to \$10 a Week Extra In Spare Time While Learning

The day you enroll, in addition to my regular Course, I start sending you Extra Money Job Sheets—start showing you how to do actual Radio repair jobs. Throughout your Course I send plans and directions which have helped many make \$5 to \$10 a week in spare time while

learning. I send special Radio equipment; show you how to conduct experiments, build circuits. This 50-50 training method makes learning at home interesting, fascinating, practical. I devote more than 10 Lesson Texts exclusively to Television methods and applications, and cover Television fundamentals thoroughly in my Course.

You Get This Professional Servicing Instrument



This instrument makes practically any test you will be called upon to make in Radio service work on both spare time and full time jobs. It can be used on the test bench, or carried along when out on calls. It measures A.C. and D.C. voltages and currents; tests resistances; has a multi-band oscillator for aligning any set, old or new. You get this instrument to keep as part of your N. R. I. Course.

Get Sample Lesson and 64-page Book Free

Act today. Mail coupon now for Sample Lesson and 64-page book. They're FREE. They point out Radio's spare time and full time opportunities and those coming in Television; tell about my Course in Radio and Television; show more than 100 letters from men I trained, telling what they are doing and earning. Read my money back agreement. Find out what Radio offers you. Mail Coupon in envelope or paste on penny postcard—NOW!

J. E. SMITH, President, National Radio Institute
Dept. OKX, Washington, D.C.

MR. J. E. SMITH, President
National Radio Institute, Dept. OKX
Washington, D. C.

Dear Mr. Smith: Mail me FREE, without obligation, your Sample Lesson and 64-page book, "Rich Rewards in Radio," which tells about Radio's spare time and full time opportunities and explains your 50-50 method of training men at home to be Radio Technicians. (No salesman will call. Write Plainly.)

Age

Name

Address

City

State

14x1

**I Trained
These Men**



**Truck
Driver
Now Owns
Business**

Before taking the N. R. I. Course I was a truck driver making \$25 a week. Now I have my own Radio service shop and turn out up to \$600 of work a month. I recommend the N.R.I. Course. J. Alan Mohr, 2047 Fillmore St., San Francisco, Calif.



**Makes \$800
A Year
In Spare
Time**

I started to earn money about 3 months after enrolling with N. R. I. and made about \$600 before graduating. In a year I earned \$800 in spare time. S. G. Pierson, Dry Creek, W. Va.



**Turning
Point
In My Life**

The N.R.I. Course has been the turning point in my life. My job as Radio operator for the Ohio State Highway Patrol has given me security, and my earnings have doubled. Thomas B. Hedges, 822 Beatty Ave., Cambridge, Ohio.

Sample Lesson FREE

My sample lesson text, "Radio Receiver Troubles—Their Cause and Remedy," covers a long list of Radio receiver troubles in auto, D.C., battery, universal, A.C., D.C., superheterodyne, all-wave and other types of sets. And a cross reference system gives you the probable cause and a quick way to locate and remedy these set troubles. A special section is devoted to receiver check-up, aligning, balancing, neutralizing, testing. You can get this lesson Free by mailing the coupon.



**Specializes
in Aviation
Radio**

I am with the U. S. Signal Corps and specialize in Aviation Radio. I am sure of a lifetime job with good pay now and better pay to come. Any man can do what I have done. Claude L. Allday, Signal Corps, Radio Section, S.A.A.D. Dunton Field, San Antonio, Texas.



**Chief
Operator
Broad-
casting
Station**

Before I completed my lessons, I obtained my Radio Broadcast Operator's license and immediately joined Station WMPC where I am now Chief Operator. Hollis P. Hayes, 327 Madison St., Lapeer, Michigan.



**Had Own
Business
6 Months
After
Enrolling**

I went into business for myself 6 months after enrolling. In my Radio repair shop I do about \$200.00 worth of business a month. I can't tell you how valuable your Course has been to me. A. J. Baten, Box 1168, Gladewater, Texas.

RADIO-CRAFT

HUGO GERNSBACK, *Editor-in-Chief*

N. H. LESSEM
Associate Editor

THOS. D. PENTZ
Art Director

ROBERT EICHBERG
Trade Digest Editor

R. D. WASHBURNE, *Managing Editor*

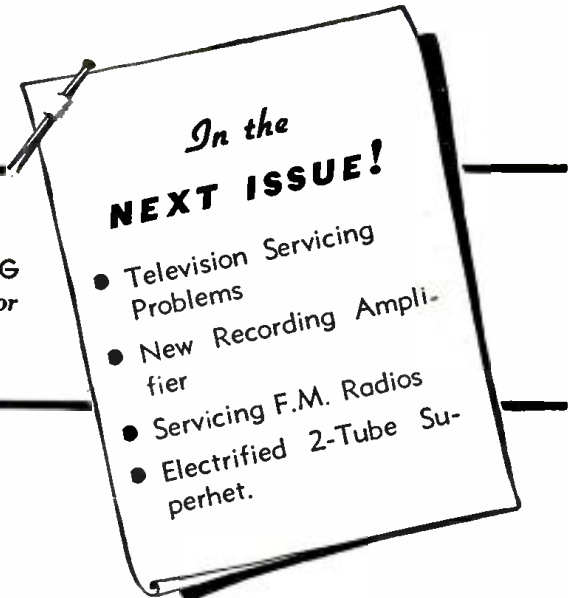

Contents OCTOBER, 1940 Issue

VOLUME XII -- NUMBER 4

Mailbag	195
Editorial: Coming Radio Changes.....Hugo Gernsback	199
The Radio Month in Review.....	200

SERVICING

Mayor's Desk-Drawer Office Radio.....R. Bernard	202
Servicing F.M. Receivers.....	204
RADIO SERVICE DATA SHEETS:	
No. 288—Stromberg-Carlson Model 411 Series Phono-Radio	206
No. 289—General Electric Models H-639 A.C. and H-639 D.C. Radio-Phonograph Combinations....	218
No. 290—General Electric Model J-71.....	220
No. 291— " " " ".....	221
The Ground and Its Relation to Radio Interference...Ted Powell	207
Model Radio Service Shop.....	214
New Circuits in Modern Radio Receivers—No. 37F. L. Sprayberry	216
Operating Notes.....	219

TEST INSTRUMENTS

Build This 21-Range Universal Test Meter.....	222
-----------------------------------------------	-----

SOUND

Sound Engineering—No. 10..... Conducted by A. C. Shaney	224
How to Make a Versatile Miniature-Tube Audio Amplifier..... H. G. Cisin, M.E.	226

ELECTRONICS

New 5/8-Volt Tubes!..... R. D. Washburne	232
Loudspeaker Violins and How They Work..... R. Vermeulen	234

RADIO DEVELOPMENTS

British G.P.O. Test Laboratory.....	239
Automatic Radio Weather Robot.....	239
Radio at the Conventions.....	240
The New Miniature Portables.....N. H. Lessem	242

DEPARTMENTS, ETC.

Mailbag	195
The Radio Month in Review.....	200
RADIO SERVICE DATA SHEETS (See Servicing)	206, 218, 220, 221
New Circuits in Modern Radio Receivers—No. 37F. L. Sprayberry	216
Operating Notes.....	219
Sound Engineering—No. 10..... Conducted by A. C. Shaney	224
Latest Radio Apparatus.....	245
Radio Trade Directory.....	249
Shop Notes—Kinks—Circuits.....	254
Book Reviews.....	256



Published by Radcraft Publications, Inc. Publication office: 29 Worthington Street, Springfield, Mass. Editorial and Advertising Offices: 20 Vesey Street, New York City. Chicago Advertising Office: RADIO-CRAFT, 520 North Michigan Avenue, Chicago, Ill.

RADIO-CRAFT is published monthly, on the first of the month preceding that of date; subscription price is \$2.00 per year in U. S. and Canada. (In foreign countries, \$2.50 a year to cover additional postage.) Entered at the post office at Springfield as second-class matter under the act of March 3, 1879.



Foreign Agents:

London—Gorrings's American News Agency, 9A Green St., Leicester Square, W. C. 2, England.

Paris—Messageries Dawson, 4 Rue Faubourg, Poissonniere, France.

Melbourne—McGill's Agency, 179 Elizabeth St., Australia.

Dunedin—James Johnston, Ltd., New Zealand.



Text and illustrations of this magazine are copyright and must not be reproduced without permission of the copyright owners.



Copyright 1940 Radcraft Publications, Inc.



Here's how you can make more money by increasing your technical ability

• New developments, new equipment, demand men with modern technical training. The man who does not keep pace with radio advancement is deadlocking his own future. Tonight hundreds of men throughout the world are devoting their spare time to CREI training . . . "tomorrow" they will be equipped to take advantage of the opportunities that await trained men in Radio and Television fields. If you have the ambition, CREI can supply the training. It costs nothing to get the facts.

Just off the Press! Write for Booklet

To enable us to send you complete information, please state briefly your radio experience, education and present position—and whether you are interested in home-study or residence training.



CAPITOL RADIO Engineering Institute

Dept. RC-10, 3224 16th Street, N. W., Washington, D.C.

NOW!

FORTUNES IN FORMULAS

10,000 RECIPES AND FORMULAS FOR HOME, FARM AND WORKSHOP

924 PAGES

The Greatest and most important formula book in print. It contains over 10,000 trade secrets, recipes, formulas and processes for home, farm and workshop.

Check-full of money-making ideas for cosmetics, soaps, perfumes, antiseptics, water-proofing, photography, a camera, paints, cements, preventive fumigants, insecticides, etc.

Book also contains following important chapters: Useful Workshop Laboratory Methods, Fully Illustrated Complete Buyer's Guide, where to buy materials at wholesale prices; Measuring Made Easy; Latin Names of Drugs and Chemicals Translated into English. Completely indexed. In short, this is a Wonder Book of Useful Knowledge! Worth its weight in gold.

Book is up-to-date and has the newest methods—latest discoveries—countless thousands of ideas—many of which you will find useful. Remember—there are actually over 10,000 clearly described formulas, processes, recipes—MANY NEVER BEFORE REVEALED.

This huge book has 924 pages, printed on good paper. Size is 8 1/2" x 5 1/4".

Send for a copy of this veritable gold mine TODAY. You will never regret it. Remember, great fortunes are often made on formulas.

\$1.00 per copy. Postage in U. S. 10c extra. (Canada and foreign countries 25c extra for post.)

Send money order, check, unused U.S. stamps or cash. (Register all letters containing cash.)

NATIONAL PLANS INSTITUTE

246-R Fifth Avenue New York, N. Y.

Attention Dealers

Attractive discounts on Wright Speakers, Ward-Leonard Relays, Resistors, Flechtheim Condensers, Supreme Instruments, J. F. D. Ballast and dial belt kits. Music Master record players, changers, recorders, Pocket Trouble light with first \$5.00 order.

ANCHOR RADIO DISTRIBUTING SERVICE
213 1/2 Dryden Road, Dept. RC, Ithaca, New York

RADIO TECHNOLOGY

RCA Institutes offer an intensive course of high standard embracing all phases of Radio and Television. Practical training with modern equipment at New York and Chicago schools. Also specialized courses in Aviation Communications, Radio Servicing and Commercial Operating. Catalog Dept. RC-40.

RCA INSTITUTES, Inc.

A Radio Corporation of America Service
75 Varick St., New York, 1154 Merchandise Mart, Chicago

JAPAN TO SO. AFRICA

Dear Editor:

By way of celebrating my 41st birthday today, I picked up a station whose call sounded like JDK or JDQ, working to Hawaii at 9:25 a.m. (S.A. time). Station call and "Hello, Hawaii," in English; speech in Hawaiian (?); music, march and organ piece recorded.

Procedure repeated at intervals, heard "Serenade in the Dark."

Station, if I heard correctly, was working on 19.79 meters at 16.116 megacycles. Signals were faint but fairly clear—about R5 or 6, but got wobbly about 9.35 a.m.

My set is a 1940, 9-valve, table radio-gram Paillard (Swiss make). The above might interest the station concerned. 73s.

P.S.—N.B. Frequently get N.B.C. (New York), Westinghouse (N. J.), Holland, Paris Mondial, Perth (Aust.), Radio Center, Moscow, etc. Not bad for an ordinary drawing-room set!

R. PERCEVAL,
2402 Moore Road,
Durban, Natal,
South Africa

RE: "10-W. DIRECT-COUPLED AMPLIFIER"

Dear Editor:

I thought you might be interested in learning that I have built the 10-watt direct-coupled amplifier, designed by Mr. A. C. Shaney, and described in an article in *Radio-Craft* some time ago.

After testing this amplifier I took it to the local theatre here and installed it with a switching arrangement so either the old amplifier or the new one could be switched in at will and within a minute's time the other would be warmed up ready for action. The results have pleased both the management and the patrons of this small-town theatre.

This was the first contact I had ever had with P.E. cells; and in fact, it was the first time I had built a power amplifier (outside of a radio set and I've had lots of experience along this line). So naturally I had some difficulties but a few questions to your Mr. Shaney and all these problems were solved in no time. Yes, sir! That guy certainly knows his stuff and is equally adept in explaining anything that one might like to know.

My difficulty was in coupling the output of the P.E. cell to the amplifier and still get quality reproduction. Believe it or not, a small diagram plus a short letter was all Mr. Shaney needed to explain the difficulty and clear up the trouble.

May I congratulate you on having such a man as Mr. Shaney as a contributor to *Radio-Craft*. And thank you, as well as Mr. Shaney.

WILBERT L. MISNER,
Radio Mfrs. Service,
Vintondale, Pa.

Take a bow, Mr. Shaney! (The article referred to appeared in the July, 1939 issue, of *Radio-Craft*.)

Dear Mr. Misner:

In the circuit you are now using, the plate current of the 76 passes through the primary of the transformer, with the result that the permeability of the iron is decreased, which, in turn, produces a corresponding decrease in primary inductance. This decreased inductance shunts the low frequencies so that you can not get any lows through.

The best solution would be to use an input transformer of a larger size. With this

YOU CAN BECOME A MONEY-MAKING RADIO EXPERT

WITH THE **New SPRAYBERRY**
Personalized
HOME TRAINING in

Radio

and

Television

You Learn Easily in Your Spare Hours
By Doing Many Experiments with Up-To-Date Equipment

Here's a really fine, up-to-the-minute Radio and Television Training that's specially designed to give you quick results **TRAINING PREPARES YOU FOR GOOD RADIO JOBS . . . AT EXCELLENT PAY.** My training starts right at the beginning of Radio . . . unfolds each subject in a simplified, logical, understandable style. You easily learn Television, Electronics, Facsimile Radio, Radio Set Repair and Installation Work, etc.

NO PREVIOUS EXPERIENCE NEEDED
It makes no difference what your education has been. I can fit you for a good-paying Radio job. Your success is my full responsibility.

YOU GET PROFESSIONAL TEST EQUIPMENT PLUS EXPERIMENTAL OUTFITS

Includes 146 Radio Parts (to build complete Receiver), Tools, All-Wave All-Purpose Analyzer, and Experimental Outfits for conducting actual experiments with your own hands.

I Supply

MY RADIO PARTS
RADIO TOOLS
ALL PURPOSE ANALYZER

EARN WHILE YOU LEARN
My **BUSINESS BUILDERS** show you how to put your equipment to practical use in handling actual money-making Radio Service Jobs shortly after you begin training.

SERVICEMEN
I offer Advanced Training for those already in Radio. Get complete details in my **FREE 52-page Book**.
The Sprayberry Course is Sold Under a Money-back Agreement

RUSH COUPON FOR BIG FREE BOOK

SPRAYBERRY ACADEMY OF RADIO
F. L. Sprayberry, Pres.
320-K University Place, N.W., Washington, D. C.

Please send me **FREE** copy of "HOW TO MAKE MONEY IN RADIO."

Name Age
Address
City State
Tear off this coupon, mail in envelope or paste on penny postcard.
Servicemen—Check here ☐

Be a RADIO SERVICE EXPERT
LEARN AT HOME IN SPARE TIME

Clear, simple, fascinating lessons—practical work with experimental kits—make training easy and fast. Up to date R.T.A. methods, under personal guidance of prominent engineer and educator, highly endorsed by leaders in radio industry. Spare-time profits soon pay for training.

START NOW — have your own business paid work with radio dealers, in factories, police, marine or television fields. **DON'T DELAY!**
Send AT ONCE for complete information and Big Opportunity **BOOK FREE!**

RADIO TRAINING ASS'N. OF AMERICA
1559 Devon Ave. Dept. RC-100 Chicago, Ill.

RADIO-TELEVISION

Oldest, largest Radio-Television school in West trains you for good pay job. Complete instruction including Radio Construction and Service, Broadcast Operating, Sound, Talking Pictures, Television, Public Address, etc. Flexible plan to meet specific needs of those with or without jobs. Transportation allowed to L.A. Earn room and board while learning. Request Free Catalog.

NATIONAL SCHOOLS Dept. RC-10
Los Angeles

RADIO COURSES

Classes Start October

- RADIO OPERATING—BROADCASTING
- RADIO SERVICING—a practical course
- RADIO AMATEUR (CODE TELEVISION)
- ELECTRONICS—1 yr. day course 2 yrs., eve. Day and Evening Classes. Booklet Upon Request.

New York Y.M.C.A. Schools
4 W. 64th Street New York City

LES Correspondence Courses in RADIO and ELECTRICAL ENGINEERING

ELECTRICAL ENGINEERING Get good train of wide electrical field. Prepare yourself, at Low Cost, for secure future. Modern, simplified, you can understand quickly.

RADIO ENGINEERING Extra fine course in radio, public address, photo-electric work. Trains you to be super-service man, real vacuum tube technician. Expts. kits furnished. Diploma on completion. Tuition \$25. other course. Deferred payment plan. Get copies of school catalogs, student magazines, complete details. **SEND NOW!**

FREE

LINCOLN ENGINEERING SCHOOL, Box 931-C22, LINCOLN, NEBR.

GOOD JOBS!
for **RADIO MEN** in
National Defense Industries
PREPARE NOW!

National defense orders are bringing about an employment boom in many plants—for certain types of trained personnel. Men who know Radio are in great demand! Here's your golden opportunity to get into a line that pays good money—that has plenty of future—and that offers good jobs right now!

IN ARMY AND NAVY, TOO!

In the military service, too, men who know radio are needed badly. They get higher ratings and higher pay. Think that over—whether you are planning to enlist or wait for conscription. A word to the wise is sufficient!

Prepare yourself now with these books in your spare time. Right in your own home, and at your own convenience, you can—

LEARN RADIO
and SERVICE WORK with
Ghirardi's **BIG 2**

RADIO PHYSICS COURSE

BASIC FUNDAMENTALS

Here's your start in Radiol! If you are a beginner, this one big, all-inclusive, short-cut, self-instruction book of nearly 1,000 pages with over 500 illustrations will give you a thorough training in the important fundamentals of Electricity, Radio, Sound, Television, Cathode-Ray Tubes, etc.—all the essentials, all the background you need for a complete radio knowledge. No math—no previous training necessary. It starts at the very beginning, teaching you all about Electricity first. And you can learn it all easily by yourself at home, checking your progress with the 858 self-examination Review Questions in the book. Ghirardi makes everything crystal-clear and easy to understand.

USED BY ARMY AND NAVY

Because it's "tops," this very same Radio Physics Course is used by the U. S. Army and Navy and by more radio schools and students than any other radio book!



\$4
972 PAGES
508 ILLUS.
856 REVIEW QUESTIONS

MODERN Radio SERVICING

LEARN HOW
with this!

This famous Ghirardi book will teach you how to test and service all types of electronic and radio equipment. It's an illustrated 1300-page "gold mine" of servicing knowledge. 420 pages explain all types of servicing test instruments—how they work, how constructed, how to build them, how to use them. Then 900 more pages give you a complete step-by-step procedure course in trouble-shooting, testing, aligning and repairing all makes of radio sets and other electronic devices. The very latest advanced scientific Factory Methods of trouble shooting and repairing are explained throughout. You learn service work easily at home with 720 self-examination review questions to check your progress.



\$4
1300 PAGES
708 ILLUS.

MAIL COUPON TODAY!

RADIO & TECHNICAL PUBL. CO., Dept. RC-100
45 Astor Place, New York City

Send postpaid, with 5-Day Money Back Guarantee:

RADIO PHYSICS COURSE \$4. (\$4.50 foreign)

MODERN RADIO SERVICING \$4. (\$4.50 foreign)

Name

Address

City

State

Please send me FREE illustrated descriptive literature.

MONEY BACK IF NOT SATISFIED.

transformer, you should use a shunt-feed resistor, so that the plate current of your tube (this should also be changed to a 6SF5 or 6F5, if higher gain is desired) is fed through the resistor.

The enclosed sketch (reproduced here—Ed.) illustrates the recommended plate coupling circuit.

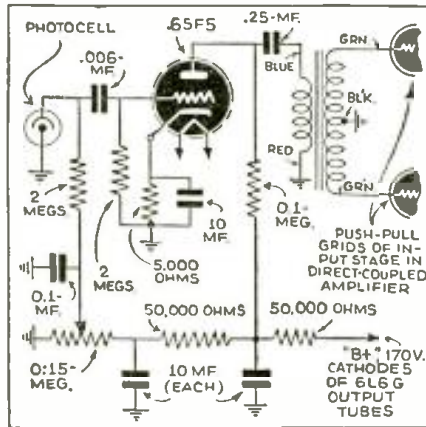

You can use a 10-mf. bypass condenser across the cathode resistor. (The 0.1-mf. cathode condenser indicated in your diagram is inadequate for good low-frequency response.)

A. C. SHANEY,
New York, N. Y.

The following card received from Mr. Andrew Plihick, Jr., is also answered by the above reply to Mr. Misner.—Editor.

Dear Editor:

Will you please show me how the All-Push-Pull Direct-Coupled Amplifier may be used with 16-mm. Sound-on-film? I am using a CE-20 photo cell, and if this amplifier does not lend itself to use with this cell, please send me a circuit of an A.C.-D.C., 6-watt amplifier, using the latest tubes out, which will be OK for use with the CE-20.

Thank you,
ANDREW PLIHICK, JR.,
New York, N. Y.

CANADIAN SOUND TRUCK

Dear Editor:

Here is a picture of our sound car. It can be loaded in 3 minutes and we operate it for street advertising on a 6-volt system. We also have a generator that will deliver 110 volts with an output of 800 watts. For large installations we have an amplifier that we use that has a peak output of 150 watts. We carry around 2,000 feet of cable in



The "long and short" of it. Sound trucks of Waddell's Sound & Radio.

our sound car at all times, to handle any type of job that we run into, and it saves greatly on the time on installations as our cables have all plug connections.

The little car is powered with two 6-volt batteries and has reverse and ahead shift foot pedal for speed and lights and horn. It has a speed of about 12 miles per hour and has been operated by my boy remarkably well since he was 3½; and the men at the shop all drive it. In the picture is one of the men that works for me and he is 5 ft. 3.

WADDELL'S SOUND & RADIO,
E. Waddell, Sales Manager,
Windsor, Ont., Canada

HE MUST MEAN IT!

Dear Editor:

I have been a newsstand buyer of *Radio-Craft* for the past 10 years and have never written you before. I have planned to do so many times but always put it off till tomorrow.

But here goes for a big thanks for everything, all the kinks and all the wonderful help I have obtained from your magazine.

I am sending my 2 bucks for a much-delayed subscription.

Here's wishing you continued success.
MR. A. B. NIDA,
San Diego, Calif.

Thanks for "everything," Mr. Nida.

GUESS AGAIN!

Dear Editor:

You seem to think there is nothing but A.C. or D.C., in other words, no "Battery Radio."

You are mistaken, there are at least a million radio fans who never will have power. Somebody ought to wake up and give service to us.

GEO. HEASLEY,
Fairplay, California

Radio-Craft is in agreement with Mr. Heasley and suggests that perhaps he has missed past issues in which articles of special interest to "battery" fans appeared. Incidentally, many of these articles have been compiled in one volume and will soon be available in Red Book, No. 26, "Modern Battery Radio Sets."

"KEEP 'R.-C.' UNDILUTED"

Dear Editor:

I want to express my appreciation of the standard of *Radio-Craft* magazine. I have been a newsstand subscriber for over 5 years, I bind all copies together yearly. There are a few copies missing, those were

lent to friends and eventually got lost. Now-a-days I do not lend out because I want to keep them on file and fear losing more copies. I also subscribe to 2 other radio magazines. I enjoy "R.-C." better because it is more interesting to me than the other magazines.

I read Mr. Frank Mill's letter in "R.-C." and fully endorse it; it reflects my viewpoint, that is, to make "R.-C." a Serviceman's magazine and not a Ham Chatter publication, as there are many other magazines, which cater mostly to the GREAT HAM FRATERNITY, therefore keep "R.-C." undiluted as a Serviceman's magazine.

Due to the war I cannot obtain an import license to order an up-to-date tube checker. I have an RCP Dependable model 305 tube tester, this is now obsolete (it will not test single-ended and local tubes); would you do me the favor of printing a diagram to reconstruct the model 305 so that I can check-up on the new tubes mentioned? Thank you.

The only fault I find with "R.-C." is, that the layout of the articles is such that they cannot be cut out and filed separately. I expect that for some particular purpose it cannot be done, therefore I have to be contented in having a bulky file.

J. H. FUNG,
9 Cornelio Street,
Port of Spain,
Trinidad, B. W. I.

It's in again! That problem of running technical stories that back one another, without having them back, and still keep the stories in their respective departments has us flooded. We can only tell Mr. Fung the same thing we told Mr. Allen (July issue, pg. 3); "... it's a 'tough job' to avoid a certain amount of backing-up of one story by another—and both worth filing!" Far be it from us to once again suggest that 2 copies be obtained each month—or do any of our readers have any other ideas?

FINDING DUMMY LOAD VALUE

Dear Editor:

Would you kindly give me a concrete example of finding the resistance of the dummy resistor used to duplicate a receivers plate load?

I thank you in advance for any co-operation you will give me.

WILLIAM J. SIMMS,
Washington, D. C.

Mr. Simms received the following reply: From the circuit involved and by referring to a tube manual you can calculate the total "B" drain at the rated operating voltage. From Ohm's law wherein the resistance R equals the voltage divided by the current, you have the dummy load value.

"ERROR" WASN'T

Dear Editor:

Apparently there is an error in the diagram (Fig. 1) on page 531 of the March, 1940, issue of Radio-Craft.

According to our method of figuring the resistances in the phase-inverter circuit, if the 6N7 tube is used and a 0.25-megohm

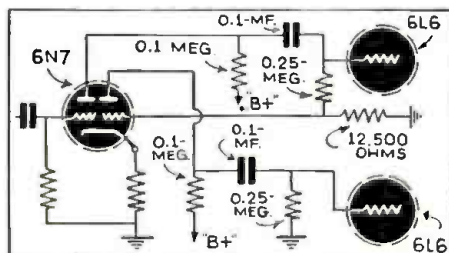

New Static-less Higher Fidelity SCOTT Frequency Modulation RADIO

AN ENTIRELY NEW AND DIFFERENT SYSTEM OF STATIC-LESS, HIGHER FIDELITY BROADCASTING AND RECEPTION

Highly perfected, FREQUENCY MODULATION radio is ready right now, for full commercial operation. A special wave band has been set aside for it by the Federal Communications Commission. You'll be first with radio entertainment of breath-taking beauty and realism, with the magnificent new custom-built Frequency Modulation receiver

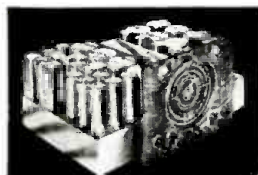

NO
STATIC
•
NO
NOISE!

developed and far advanced by E. H. Scott.

UNDREAMED OF TONAL REALISM

Scott "F.M." radio sound reaches the full capacity of the human ear... 2 to 3 times more fidelity than our present system of broadcasting! Tone and detail are more real and beautiful than can possibly be imagined. Because entirely new and different electrical characteristics are used. YOU HEAR NO STATIC OR NOISE. even with lightning flashing within the "F.M." station area. The wonder of the new Scott Frequency Modulation receiver is beyond description. For the first time, voice and music *exactly as heard in the auditorium* can be brought into your home by radio!

GUARANTEED FOR FIVE YEARS!

Custom built to-order, with the precision of fine scientific equipment, yet moderately priced. Be first to own this revolutionary new kind of receiver. ACT NOW.

Mail the Coupon Today—Big Cash Savings If You Act Now!



E. H. SCOTT RADIO LABORATORIES, INC.
4404 RAVENSWOOD AVE., DEPT. 24R40, CHICAGO, ILL.

Send all facts, special offer, analysis of Scott receivers, and order blank. NO obligation.

Name

Address

STUDIOS:
CHICAGO, NEW YORK, BUFFALO, DETROIT, LOS ANGELES

6L6 grid resistor is employed, the resistor from the 2nd grid of the 6N7 to ground should be 12,500 ohms; and furthermore, the resistor from the grid of the lower 6L6 should not tie-in as shown but should run direct to ground from the lower end of the 0.25-megohm resistor. We may be wrong and if so would like to know the reason this particular method was shown.

JAMES R. APPLEWHITE,
(Public Address and
Camera Equipment
and Supplies)
Browns town, Ind.

The following reply was sent to Mr. Applewhite.

Figure 1 of the circuit published in the March, 1940 issue, page 531, is correct.

The phase-inverter circuit is a new self-

balancing type. The unusual variation employed provides for degeneration in the grid of the 2nd section of the inverter tube. It also automatically balances wide variations between the triodes of the inverter tube.

LIKES "NEW" RADIO-CRAFT

I should like to compliment you on an excellent magazine, and since you have "streamlined" it, you have the handiest, most readable (and usable) make-up of any magazine I've seen yet. I take several other technical periodicals, and I believe yours is outstanding and unique. I like it because it is just "as it is." Therefore, I beg to vote NO on any transmitter articles. I've bought "R.-C." from the first copy and I like it "as is."

A. H. POST,
Dallas, Texas

For Better Servicing - For Bigger Profits— USE GERNSBACK MANUALS AND BOOKS!



SINCE 1931 Servicemen have been buying more GERNSBACK OFFICIAL RADIO SERVICE MANUALS year after year. The authentic material, easily accessible diagrams and complete service data make them invaluable to dealers and radio Servicemen. Without a Gernsback Service Manual at the repair job, there's time and profit lost. Your service kit or laboratory is incomplete without all the GERNSBACK OFFICIAL RADIO SERVICE MANUALS. There are GERNSBACK MANUALS for servicing auto-radios, also refrigeration and air conditioning equipment.

VOLUME 7 OFFICIAL RADIO SERVICE MANUAL

Over 1,800 Pages • Over 3,000 Illustrations • Stiff, Leatherette, Looseleaf Covers • Size 9 x 12 Inches • Net Weight 10½ lbs. **\$10.00**

1936 OFFICIAL RADIO SERVICE MANUAL

Over 1,200 Pages • Over 2,500 Illustrations • Stiff, Leatherette, Looseleaf Covers • Size 9 x 12 Inches • Net Weight 8 lbs. **\$7.00**

1935 OFFICIAL AUTO-RADIO SERVICE MANUAL

Over 240 Pages • Over 500 Illustrations • Flexible, Leatherette, Looseleaf Covers • Size 9 x 12 Inches • Net Weight 1¾ lbs. **\$2.50**

1934 OFFICIAL RADIO SERVICE MANUAL

Over 800 Pages • Over 2,000 Illustrations • Flexible, Leatherette, Looseleaf Covers • Size 9 x 12 Inches • Net Weight 2¾ lbs. **\$3.50**

1932 OFFICIAL RADIO SERVICE MANUAL

Over 1,000 Pages • Over 2,000 Illustrations • Flexible, Leatherette, Looseleaf Covers • Size 9 x 12 Inches • Net Weight 4½ lbs. **\$5.00**

OFFICIAL REFRIGERATION SERVICE MANUAL

(Volume II)
Over 352 Pages • Over 300 Illustrations • Flexible, Leatherette, Looseleaf Covers • Size 9 x 12 Inches • Net Weight 1½ lbs. **\$5.00**

OFFICIAL AIR CONDITIONING SERVICE MANUAL

Over 352 Pages • Over 600 Illustrations • Flexible, Leatherette, Looseleaf Covers • Size 9 x 12 Inches • Net Weight 2¾ lbs. **\$5.00**

To order these famous Manuals, see or write to your jobber or favorite mail order house. If more convenient, mail coupon directly to publishers.

RADCRAFT PUBLICATIONS, Inc.
20 VESEY STREET NEW YORK, N. Y.

RADIO-CRAFT LIBRARY SERIES

Get into the swing of reading instructive, authoritative books on technical subjects—radio, air conditioning and refrigeration. It's the easiest, quickest and most inexpensive way to improve your knowledge on these topics. In this series, popularly known as the RADIO-CRAFT LIBRARY SERIES, are all the titles necessary to your personal advancement. Only by careful study of these enlightening books, can you gain adequate experience in fields of radio, air conditioning and refrigeration. Each book is uniform. The volumes measure 6 x 9 inches—contain 64 pages, and have stiff, flexible covers. PRICE 50c PER BOOK. All books are sent to you postpaid.

Here Are The Titles:

Book No. 3 THE SUPERHETERODYNE BOOK	Book No. 18 POINT-TO-POINT RESISTANCE ANALYSIS
Book No. 6 BRINGING ELECTRIC SETS UP-TO-DATE	Book No. 19 PRACTICAL RADIO KINKS AND SHORT CUTS
Book No. 9 AUTOMOBILE RADIO AND SERVICING	Book No. 20 THE CATHODE-RAY OSCILLOSCOPE
Book No. 10 HOME RECORDING AND ALL ABOUT IT	Book No. 21 BREAKING INTO RADIO SERVICING
Book No. 13 ABC OF AIR CONDITIONING	Book No. 22 NEW RADIO QUESTIONS AND ANSWERS
Book No. 14 POCKET RADIO GUIDE	Book No. 23 PRACTICAL PUBLIC ADDRESS
Book No. 15 ABC OF REFRIGERATION	NEW—Book No. 24 AUTOMOBILE RADIO PRINCIPLES AND PRACTICE
Book No. 16 PRACTICAL RADIO CIRCUITS	
Book No. 17 SERVICING WITH SET ANALYZERS	

EACH BOOK IN THIS SERIES—50c

RADCRAFT PUBLICATIONS, Inc., 20 VESEY ST., NEW YORK, N. Y.
Gentlemen: Enclosed find my remittance of \$..... for which send me, POSTPAID, the Manuals or Books indicated below by a cross (x) in the panel.
() Volume 7 @ \$10.00 () 1936 Manual @ \$7.00 () 1934 Manual @ \$3.50
() 1935 Auto-Manual @ \$2.50 () 1932 Manual @ \$5.00
() Refrigeration Manual (Vol. 2) @ \$5.00 () Air Conditioning Manual @ \$5.00

RADIO-CRAFT LIBRARY SERIES @ 50c EACH

Circle book numbers wanted: 3 6 9 10 13 14 15 16 17 18 19 20 21 22 23 24

Name Address

City State

(Send remittance in form of check or money order; register your letter if you send cash or unused U. S. Postage Stamps.)

RC-1040

RADIO-CRAFT

"RADIO'S GREATEST MAGAZINE"

... revolutionary changes taking place in radio will profoundly affect all in the radio industry

COMING RADIO CHANGES

By the Editor — HUGO GERNSBACK

WE are living in such a stirring time that frequently we lose our perspective and do not realize how vast are the changes which come on imperceptibly, yet with such speed that it behooves us to take an "inventory" of what is certain to come about in the near future.

I had occasion to talk a number of times about the revolutionary changes that are taking place in radio broadcasting, in connection with frequency modulation (F.M.). It seems the revolutionary trend in the broadcasting business is clearly visible to everybody now when practically all radio manufacturers are tooling-up for F.M. receivers and when broadcasters are adding F.M. at a steadily accelerating pace. At the present time, many of the major broadcasters are adding frequency modulation simply as another link, and broadcast both F.M. and A.M. programs simultaneously. Therefore, those listeners who have frequency modulation sets will be able to receive the broadcasts on these carriers while the others, still in the majority, of course, for some time to come, will make use of their present sets.

If, however, we know anything about the tempo of the American public, we know that it will not be long before frequency modulation sets will have replaced the majority of the present day sets.

The same thing occurred a few short years back when all-wave radio sets (so-called) swept the land and when practically every receiver (except the lower-priced ones) was equipped with shortwave-band reception.

To the Serviceman this spells more business—more servicing, more installation—and if he knows what he is doing, he will boost F.M. wherever he can, particularly in the localities where F.M. is received.

Next on the program is our great rearmament cycle now in full swing. Few people appreciate the tremendous extent of this movement and how it will affect all of our lives.

Just what does all of this mean to the radio man? Patently the entire radio industry is profoundly affected from top to bottom. Scores of radio manufacturers are already busy turning out Government orders and it will not be long before all of them will get a share of the huge radio business already contracted for, with more to be placed very soon, by our Government. This means more employment as far as radio factories are concerned, and we know many of them which are already working on 3 shifts in order to keep up with large orders placed by several branches of the Government. On the other hand, it should also be remembered that when several millions of men will be drafted into the Army and other branches of the Government to serve under the colors, this immediately will drain the field of a goodly percentage of radio men; this translated simply means that there will be more work for those who are not in the armed services. Thus, for instance, the radio servicing industry will, for the time being, get more business per Serviceman because some of the competition is being eliminated, while coupled with this there will be very large demands on radio servicing because more

receivers are being sold right along. All this in turn inevitably must mean more and better business for those not drafted. Inversely, those who are not Servicemen will have greater opportunities than ever in serving the radio industry in its various branches be it factory, sales, broadcasting, etc.

Even those who are sure to be drafted can better their position by taking advantage of their radio knowledge. All branches of the Government, the Army, Navy or Air Force, require trained radio personnel, and those who are well trained will, naturally, be in a better position than those who are not.

For this reason, I would strongly recommend to those young men who are sure to serve under the colors, to immediately study and equip themselves in certain endeavors. What these endeavors are only the individual himself can answer. If, for instance, you are a young Serviceman now and have a good training at this trade, it will stand you in good stead when your turn comes.

But that alone is not enough. There has always been a shortage of telegraph men—that is, those who know the code and can both send and receive. It is not a difficult thing to learn this in your spare time and now is the time to do it. Fortunately, almost any radio man for a paltry few dollars can rig up a buzzer set and start training himself in code transmission and reception.

One more important point to remember is that most of us in pursuing our different endeavors frequently become too one-sided. This is natural because we subconsciously try to become expert at whatever we are working on. Thus, it has come about that the Serviceman frequently knows very little outside of radio besides his servicing routine. The average Serviceman is not at all expert when it comes to transmitters and receivers such as are used by amateurs or professionals, for example, yet the Serviceman who has a fundamental knowledge of radio servicing will not find it hard to take up radio transmission and reception as it is practiced today. Then too, many Servicemen do not know a great deal when it comes to the several phases of electronics. Conversely, the radio amateur knows little about radio servicing and often not much either of electronics because he is too much steeped in his knowledge of ham transmitters and receivers. In normal times such a condition may be satisfactory, but when you are drafted into the Service of the Army, Navy or Aviation, then an all-around knowledge of radio will help you greatly to better yourself, and your chances for promotion are ever so much greater.

For this reason all those who know that they will have to serve sooner or later should make themselves letter perfect in as many radio branches as they can conceivably master. In any event, this knowledge will never be lost because when things get back to normal—as it always does—the accumulated knowledge will be certain to prove valuable, particularly when competition during normal times will be again at its peak.

A word to the wise should be sufficient!

•THE RADIO MONTH IN REVIEW•

The "radio news" paper for busy radio men. An illustrated digest of the important happenings of the month in every branch of the radio field.

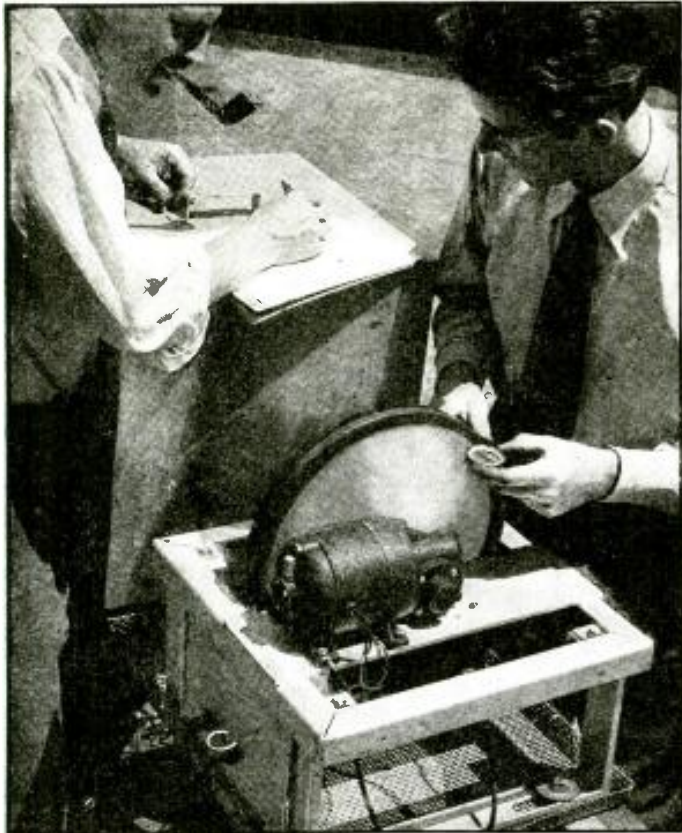

FULCHROGRAPH!

This new device, developed, by Westinghouse lightning engineer Gilbert D. McCann, is capable of measuring the current and making a complete diagnosis of a direct lightning stroke. The purpose of these measurements, placed at many vulnerable points (at the base of an antenna mast, etc.) throughout the nation, is to compile an exact record of all common forms of lightning strokes. The instrument consists of a motor turning a slotted aluminum wheel filled with magnet steel projecting like small fins, and rotating through 2 coils which carry the current from the lightning stroke. The amount of magnetizing in the fins is then measured. Mr. McCann is here shown using a compass to check the presence of magnetisms in the recording wheel.

ABROAD

ONLY a very small portion of the events of last month in which radio facilities played a role can be chronicled here.



PORTABLE TELEVISION PICK-UP

"As compact as a movie sound camera and just as easy to operate" nicely describes this new DuMont equipment. The camera is of the iconoscope type, with image focused by an F:2.5, 9 1/4 in. focal length lens. Camera measures 8 3/4 x 26 x 16 1/2 ins. overall and weighs but 45 lbs. It carries the preamplifier. The associate equipment: camera power supply (9 x 17 x 10 ins., weight 45 lbs.); I.F. amplifier and iconoscope scanning voltage generator (14 1/2 x 20 x 8 ins., weight 37 lbs.); power supply for I.F. amplifier and scanning unit (14 1/2 x 20 x 8 ins., weight 52 lbs.); besides this there are the 45-lb. line amplifier, the 54-lb. video monitor and the synchronizing signal generator put up in 2 units weighing 38 and 43 lbs., respectively. Two operators can handle all the equipment.

England.—An Emergency Powers Act ruling now prohibits radio sets in automobiles, in England. Continuing its campaign to nip in the bud any 5th column activities, only authorized persons are permitted to possess signaling apparatus (including radio transmitters), reported *Radio Daily*.

Tokio.—The Japanese news agency, *Domei*, reported 19 foreigners were arrested at Dairen, in the Japanese-leased territory of Kwantung, on the charge of possessing shortwave radio sets and of disseminating anti-Japanese propaganda.

France.—During the months WOR-Mutual's commentator Waverly Root broadcast from France he had many unusual experiences. For instance, on many occasions, after the period of check-up prior to being cut into the network program, Root would listen-in to the program he was to follow—usually Raymond Gram Swing. Frequently he learned facts concerning the situation in France not known even to American reporters in Paris, because of French censorship!

India.—From far away India comes word via *The Indian Listener* that the Government of India has finally found it necessary to place a ban on the public dissemination of enemy broadcasts. "Since the war," the item begins, "it has been the policy of the Government of India not to interfere with broadcasts from Germany directed to India but to allow this propaganda to defeat itself by its obvious exaggeration and mendacity. This policy has justified itself by results; nowhere in India is there anything except distrust and loathing of what Nazi Germany stands for.

"German propaganda has been discredited

not only by its own obvious demerits, but also because the people of India have been able to obtain from All-India Radio and from the press correct news, etc." Lately, however, the government of India has been receiving reports from many different classes of persons indicating that in the present critical times "it is desirable to protect the public from the exploitation of their natural fears, as a result of rumors directly traceable to enemy broadcasts, which in some parts of the country have disturbed the confidence of the people even to the hoarding of stocks, withdrawal of money from banks, etc."

F.M.

WE give the opening of this press release to you unadulterated: "With frequency modulation broadcasting, radio engineers may have to be one-man weather bureaus, keeping an alert eye out both for hot weather and hot orchestras," says pioneering F.M. expert J. R. Poppele."

It is said that engineers conducting tests for the new WOR transmitter discovered that certain changes in atmospheric conditions, natural and man-made, definitely affect the transmission of high-frequency sound waves. High studio humidity results in loss of high frequencies. Outside weather conditions do not affect the air-conditioned studios but a group of persons working in a studio for a length of time will affect temperature and pressure, and hence, the reason for Chief Engineer Poppele's statement that eventually F.M. control panels may have another unit for air conditioning—so that the engineer will be able directly to control the humidity and atmosphere of the studio. Open-air broadcasts over F.M. frequently present a problem when the air becomes muggy just before a storm.

First West Coast F.M. transmitter to go on the air was W10XLV. Transcriptions, and programs of station KSFO, San Francisco, were included among the airings on 43.4 mc. under a temporary license issued by the F.C.C. for use of the (1-kw.) transmitter at the 17th Annual Convention of the National Association of Broadcasters.

WBZ's new 50-kw. transmitter was formally opened last month. Westinghouse's new Boston-area station is designed for shortwave operation and frequency modulation in the future, and is capable of "carrying" the frequency range of 30 to 15,000 cycles.

Indianapolis Power & Light Company's service vehicles are now equipped for 2-way F.M. operation as an emergency communications system. The 10 service cars and trucks carry 25-watt transmitters, contacting main headquarters where a 250-watt unit is located. I.P.&L. found that F.M. serviced twice the area of equal-powered A.M. equipment.

We quote Doug Watt from his column "Listening In", in a news item on the dedication program to W2XOR, "One of the many odd facts about F.M. is that announcers and performers will have to stand at least 6 feet away from the mike." . . . WOR's new F.M. transmitter, W2XOR, is served by 3 power lines to reduce the possibility of service interruption due to storms, etc. This W.E. transmitter is designed to operate over an audio range of 20 to 16,000 cycles (erroneously states a press release, "the full range of human hearing") . . . W2XOR's 2 broadcast phone lines from the transmitter at 444 Madison Avenue to the

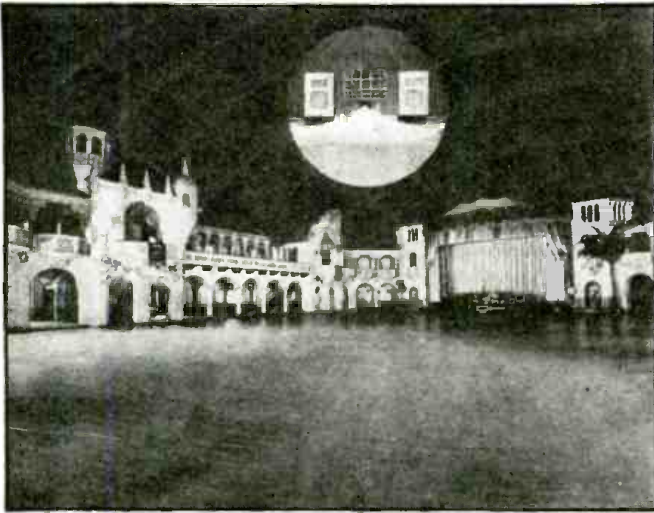

BALLROOM "ENHANCED" P.A.

Six thousand dancing couples in Chicago's huge Aragon Ballroom create quite a noise level for any P.A. system to overcome. Western Electric does it with special equipment consisting of directional loudspeakers, directional microphones and special amplifiers of controllable frequency range. The circular insert shows a cluster of high- and low-frequency speakers (and concealed in the striped covering atop the canopy, in the main photo, at immediate lower-right). Cellular horn in the center projects sound vibrations above 400 cycles/sec., flanking speakers operate below 400 cycles. A large control panel resembling a pipe-organ console handles instrumental "enhancement."

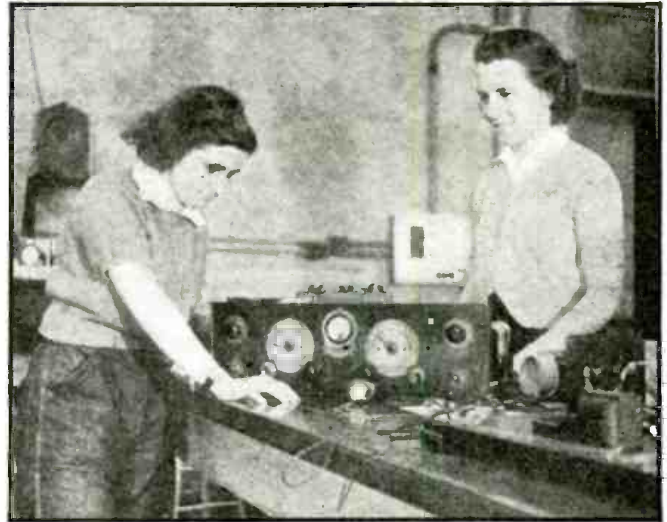

MT. HOLYOKE COLLEGE RADIO COURSE

Mount Holyoke College, exclusively for girls, has a popular course in Radio Communications. Above are Miss Barbara A. Wright and Miss Reina Sabel experimenting with an old radio set which they have rebuilt. Much use is made of old radio equipment, some being kept intact to illustrate radio evolution and others being torn down for rebuilding into more modern equipment. Still other sets afford the class an opportunity to make tests and run down faults. This training is under the direction of Rogers D. Rush, Assoc. Prof. It has been found that the majority of the students of this course in Radio Communications express a desire to continue their studies and experiments.

studios at 1440 Broadway "handles" up to 20,000 cycles. Highest-quality broadcast phone lines now only go to 9,000 cycles.

TELEVISION

F.C.C. Chairman Fly reports that a Communications Board will be set up, probably by order of President Roosevelt (under Section 606 of the Communications Act, which grants sweeping powers to the President in case of emergency), to co-ordinate wire and radio broadcasting facilities for national defense purposes.

Philly received Republican Convention coverage by television via Philco's Station W3XE. The station had a television audience estimated at about 5,000 persons . . . Philco last month committed itself as being ready to manufacture and sell television receivers "as soon as conditions warrant." . . . Station W2XWV, when it begins operation this fall, will transmit images even more detailed than NBC's new 507-line image, Du Mont Laboratories reports . . . The Du Mont television "network" now includes a Class 2 television broadcaster in New York City—W2XWV, temporarily a 50-watter at 515 Madison Avenue, soon scheduled to go up to 1 kw. on 78-84 mc.—for program research; W2XVT, an experimental transmitter at Passaic; and, W10XKT, a mobile transmitter.

Industry's reply to F.C. Commissioner Fly's statement that the Commission was prepared to adopt television standards as soon as the industry agreed upon a set of standards (as reported last month in this department) was the formation of the National Television Systems Committee under the auspices of the Radio Manufacturers Association. Addressing the first meeting of the Committee, Commissioner Fly, as the principal speaker, included in his remarks the statement that, "I don't want anyone to ask me arbitrarily when television will be ready for commercial operation. That job is yours." . . . At a press conference last month, Commissioner Fly remarked that, "What we need is more work and less talk on television."

Kolorama Laboratories last month received approval of reorganization plans. The company holds several television patents.

To prevent outgoing television signals from being picked-up by equipment in its new studios (atop Mt. Lee overlooking Hollywood), and thus causing feedback; and, as well, to eliminate outside interference, W6XAO's new mountain-top home has been entirely copper-shielded.

Advance information of interest to the motorists concerning Pennsylvania's Turnpike Highway was broadcast by television over NBC's W2XBS on a film prepared with the aid of Packard Motor Co.

The annual Pacific Coast American Legion Mobilization call, which was broadcast over the Don Lee network in the studios of W6XAO, was also simultaneously telecast; or, to quote a news item, "For the first time in history, television aided in a test mobilization of civilian agencies."

SHORTWAVES

A MATEUR radio afforded the only means of communication to Charleston, S. C., last month, crippled by an inundation due to a tropical storm.

A mock disaster at Greenport, L. I., last month afforded 100 amateur radio operators an opportunity to show how they could handle an emergency; centered around amateur air pilots and boat owners, solving a hurricane "problem" in a test, sponsored by Relief Wings, Inc.

A hooded cobra about to strike was charmed to inaction by a program received over a portable radio set, a resident of India wrote to the *American Weekly* last month. . . . What was said to be a low layer of ionized air which probably bounced radio waves back toward the earth, was said to explain the reception by West Palm Beach, Fla., police authorities last month of police calls as far away as Palm Springs, Calif. . . . Police of Denver, Colo., last month found that the reason radio patrol could not pick up headquarters on their car sets was

that some one had permanently borrowed without permission the antenna from each car, A.P. reported.

BROADCASTING

PACIFIC COAST stations—at least 32 of them—cut der Fuehrer off the air, last month, during an address to the British Empire being rebroadcast in America, *INS* reported. It seems that the Mutual-Don Lee network felt that the talk, after being on the air for about a half-hour, was becoming too greatly anti-public interest, and was "not in harmony with the attitude of the Government."



POLICE 2-WAY F.M. RADIO

Connecticut State Police are believed to be the first to try out a new 2-way radio system using frequency modulation. Mr. S. E. Warner, radio supervisor, and Professor D. E. Noble are shown adjusting the first mobile unit. The complete installation will include a Link transmitter and Link receiver at high elevations near each of 10 barracks, including the Hartford Headquarters. About 250 police cars will be equipped with mobile transmitters and receivers for 2-way communication. Operating frequency will be somewhere near 40 megacycles.

MAYOR'S DESK-DRAWER OFFICE RADIO

Xtra Money for Servicemen

Mr. Serviceman or Serviceman-Dealer: Busy business men are natural prospects for an office-desk built-in radio receiver. Some unusual problems in connection with an actual installation in an executive's office is the subject of this article. Details for adapting a standard Pilot battery-electric portable to this service are given.

R. BERNARD



Fig. A. Jimmy Walker (standing) happened to be in Mr. LaGuardia's office when the latter was presented with his desk-drawer radio set. Beaming, the present Mayor turned to the ex-Mayor and said: "Look what they gave me, Jimmy. Isn't it swell? You never had anything like this!"



Fig. B, above, and Fig. C, below, Pilot T-71 battery-electric portable, before mounting in desk drawer.

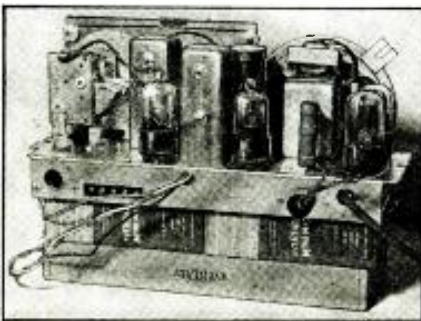

WHEN WOR last month presented New York's Mayor LaGuardia with a specially-built—and completely self-contained—desk-drawer radio set, the station may have started a ball rolling that will prove to be very profitable for Servicemen everywhere.

Now, when the Chief Executive of New York City wants to listen not only to the city's own station, WNYC, but any of the radio stations within range of a sensitive radio set, he has only to open a desk drawer and if its built-in radio receiver is tuned to the station he will hear it. The set uses direct-heater battery tubes, and hence starts to play immediately the drawer is opened.

Business men everywhere are prospects for an installation of this sort.

Inasmuch as there are several problems peculiar to the selection and installation of a radio receiver for use in a desk, which may not occur to the average radio Serviceman, these problems as they arose and were solved in the case of Mayor LaGuardia's installation are here described.

MECHANICAL PROBLEMS

The first problem was that the set had to fit in the colonial decoration pattern of the Mayor's office. Using a commercially-available receiver chassis and re-mounting it on a new panel finished to match these decorations solved this problem.

The solution tied-in with the second problem which was that the radio set must not bulk on his desk which hasn't even a telephone. Official edict that the decor of the room remain unspoiled was solved by fitting the receiver chassis and its special panel into a drawer of the Mayor's desk.

(See photo on front cover of this issue.)

The receiver which WOR's chief engineer, J. R. Poppele, specified for this installation was the Pilot T-71 battery - electric portable shown in its original form in Fig. B.

This receiver is a 5-tube superhet. with a loop antenna. The tuning range is 561 to 187 meters. Being loop operated, one of the first barriers to be hurdled was the loop antenna's directional characteristic, which ordinarily would prevent reception in 2 directions. The remedy lay between providing facilities for moving the loop or the desk, or of redesigning the loop; the latter proved simplest. The loop, rewound on 4 pegs set in the corners of a square of wood, was placed horizontally in the desk drawer to obtain non-directional reception.

Another problem to which Servicemen must pay particular attention is the fact that, as in the case of Mayor LaGuardia's installation, it may be necessary to mount the chassis horizontally on the top panel. Inasmuch as this places the tubes in a horizontal position it may be necessary—as it was in the case of the type T-71 receiver—to slightly rotate the sockets so that the tube filaments will hang in their natural positions and will not short against other elements. In the instance given, the guide mark in each case was on top, so that each filament hung straight up and down. Each filament then fell in the space provided for it rather than close to the other elements.

Some desks may be provided with drawer stops which will prevent the drawer coming out far enough to drop upon or bump against the floor; either action would risk breaking the comparatively delicate battery tubes. The Mayor's desk drawer is fitted

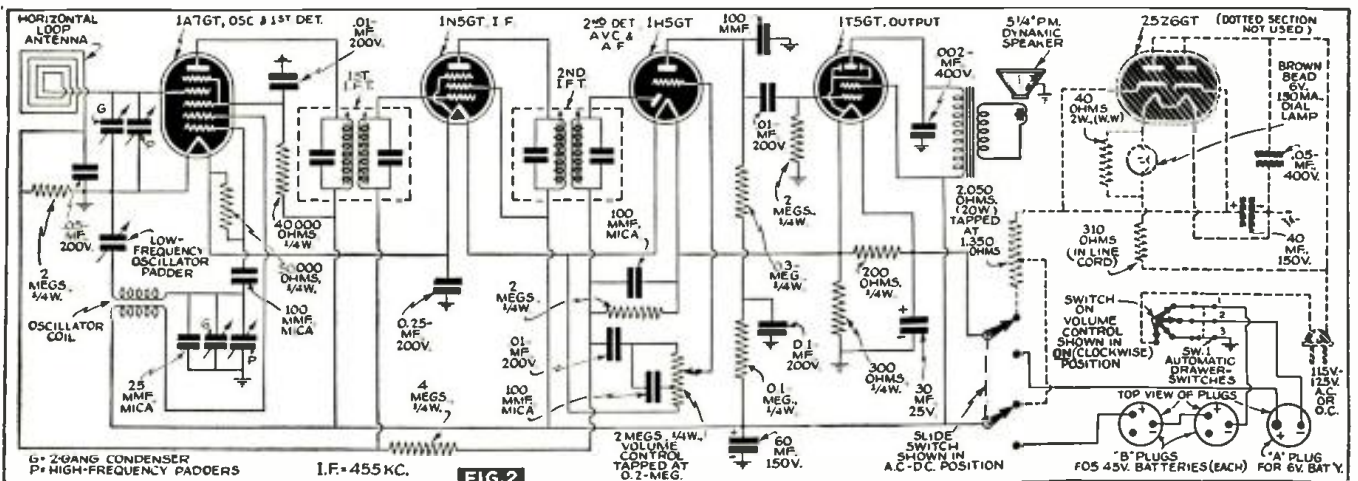

Pilot Won't Let You Down Anywhere!

RADIO

"Has not let you down since 1908."

Pilot Radio Corporation, Long Island City, N. Y.

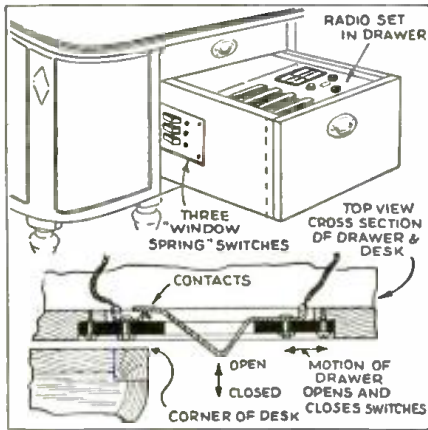

Fig. 1. Closing the drawer operates 3 ganged off-on switches, 1, 2, 3, one each in the "A-", "B-", and ground leads.

with a stop so that the drawer pulls out only about 9 ins. which is ample to permit reaching the controls.

The drawer affords such a large amount of space behind the panel, and the output power of about 200 to 300 milliwatts is so low, it is not necessary to provide any louvers for loudspeaker back-pressure release, in order to obtain quite satisfactory tone quality.

So much for the mechanics of this installation. A comparison of the schematic circuit shown here (Fig. 2) with the factory diagram of the receiver as originally designed would show that the circuit has been altered to meet the new requirements.

CIRCUIT VARIATIONS

First of all, the A.C.-D.C. electric power operation feature has been eliminated. It was felt that by slightly redesigning the power supply practicable operation could be obtained for about 500 operating hours on battery supply. Too, this would eliminate the necessity of running wires for power lines and providing outlets at the desk. By connecting a twin set of batteries in parallel with the original battery group (both sets of batteries being housed in the drawer) the desired length of service on one "loading" is obtained.

Another circuit variation is the use of a special triple-pole single-throw arrangement of 3 individual single-pole switches, mounted on a bakelite plate, so as to afford positive off-on operation when the desk drawer is opened or closed. Each leaf-type switch operates on the compression principle and is the type of switch put in windows for use in burglar alarm systems. The installation of this type of switch to meet individual conditions will require little mechanical ingenuity on the part of the Serviceman. See Fig. 1.

Here is an opportunity for aggressive radio Servicemen to drum up additional business. The order to install and service a built-in desk radio set frequently would result if Servicemen would only suggest to their customers the installation of a new or rebuilt radio set.

Turn to Page 238 for important FREE OFFER for Subscribers to RADIO-CRAFT



WHAT HAS HE GOT THAT I HAVEN'T GOT?

DID you ever stop to wonder how some servicemen get more business and make more money than you? Here, perhaps, is the answer. The most successful men in any business are those who have learned never to pass up any thing that will help them to accomplish an important job in less time.

This practice of taking advantage of every aid to better work in less time is often the only thing that stands between success and failure. In the radio service business, the man who uses all the information he can get to make trouble-shooting quicker and surer is the one who forges ahead. He's the man who has always had a complete set of RIDER MANUALS. He knows how foolish it is to depend on his own memory or intuition when complete, authoritative data can be at his fingertips for only 3c a day.

RIDER MANUALS give you, in the most convenient form, complete data on every set you may be called upon to service . . . data on alignment, I-F

peaks, operating voltages, parts lists and values, voltage ratings of condensers, wattage ratings of resistors, coil resistance data, etc.

If you don't have a complete set of eleven RIDER MANUALS, you are overlooking one of the surest ways of speeding up your trouble shooting and increasing your profits.

YOU NEED ALL ELEVEN RIDER MANUALS

Volume	Price	Covering	Volume	Price	Covering
XI	\$10.00	Up to	V	\$7.50	1931-35
X	10.00	May 15, 1919	IV	7.50	1933-34
IX	10.00	1938-39	III	7.50	1932-33
VIII	10.00	1937-38	II	7.50	1931-32
VII	10.00	1936-37	I	7.50	1920-31
VI	7.50	1935-36			

JOHN F. RIDER, PUBLISHER, INC.
404 Fourth Avenue, New York City
Export Division: Rocke-International Elec. Corp.,
100 Varick St., N. Y. C. Cable: ARLAB

VOLUME XI HAS MANY NEW FEATURES

Includes data on FM receivers released up to press time.
New Index . . . cross-indexed for easy reference.
New "How It Works" section, with up-to-date information on the latest developments.
New Vest Pocket Supplement contains much useful information for on-the-spot reference.

You NEED RIDER MANUALS

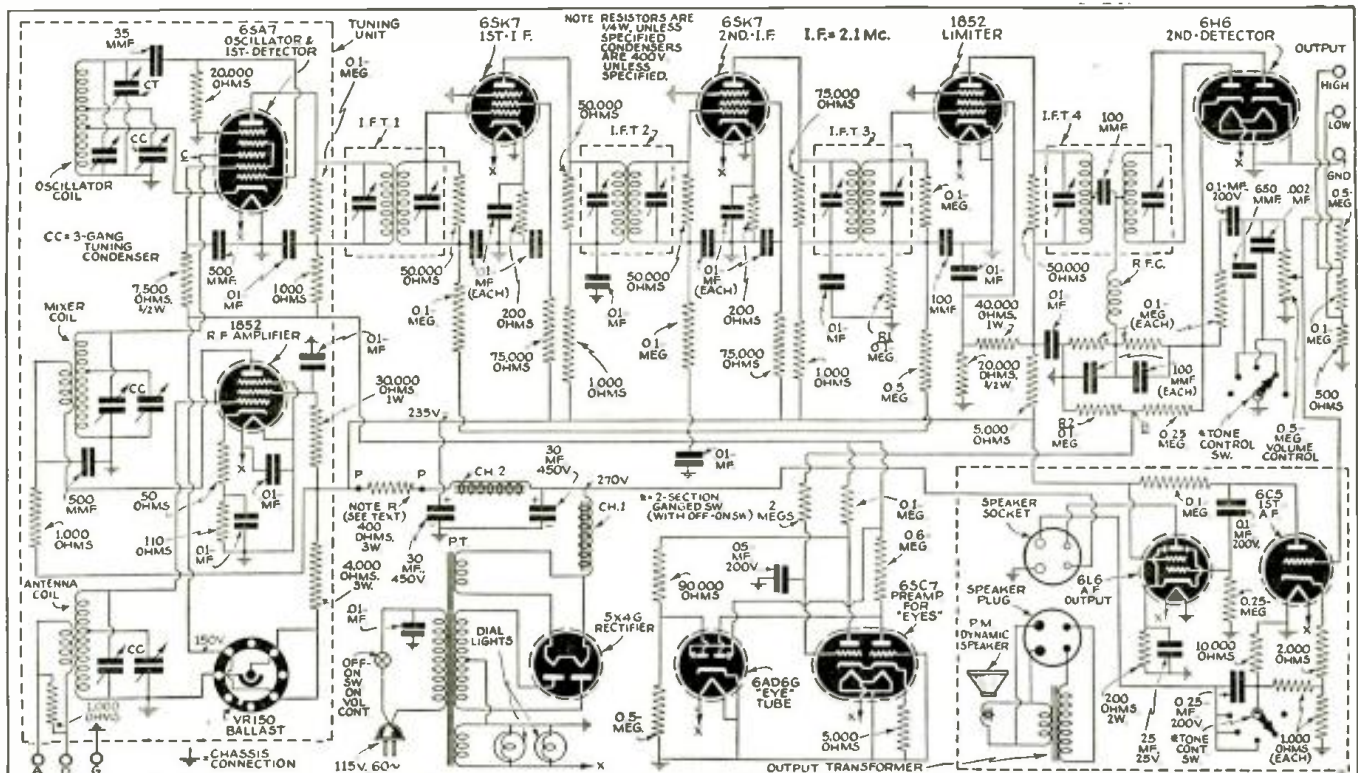

Figure 1. The Meissner model 9-1021 Frequency Modulation Receiver; for completeness the circuit of a recommended 4-watt A.F. channel has been added (dotted enclosure) to this kit-type set, the diagram of which is here being used as an example of F.M. receiver design for purposes of discussion.

SERVICING F.M. RECEIVERS

Frequency Modulation receivers, combination F.M.-A.M. receivers, and F.M. add-on adapters, are rapidly making their appearance on the market. With F.M. transmitters sprouting up all over the United States, radio Servicemen will find the following detailed description of F.M. servicing procedure—described in comparison with orthodox A.M. servicing technique—an article worth studying; and worth filing for future reference if it has no immediate application in the reader's locality.

THERE are similarities and differences between Frequency- and Amplitude-Modulated-wave receivers. When possible in the following discussion, a comparison will be made between F.M. and A.M. receivers.

The input end of an F.M. receiver may or may not have an R.F. stage. Open- or short-circuited coils and condensers may occur and can be tested-for in the usual manner. Alignment is more difficult because few generators are available for the high frequencies at which frequency modulation receivers operate. Because of the small percentage frequency range included in the band, signal generators can not be depended upon to establish calibration points on the dial. If a station can be heard, it is best to set the dial at the frequency of that station, and align the oscillator trimmer until that station comes in at the proper point.

In almost all broadcast band receivers, the oscillator frequency is *above* the signal frequency by a difference equal to the intermediate frequency. *On F.M. receivers, the oscillator may be above or below the signal frequency.* A reason for keeping the oscillator below the signal frequency is that some improvement in stability and strength of oscillation can be obtained with the oscillator at the lower frequency.

R.F. CIRCUITS

In aligning the R.F. antenna trimmer for maximum response, an output meter in the audio is not satisfactory because the *limiter tube* makes the output uniform for all but the very weakest and very strongest signals.

At the limiter-tube control-grid, variations in grid current or voltage are obtained when the signal level varies. The grid current at this point may vary between 5 microamperes and 200 microamperes for a usable signal. For this reason, the common 0-1 milliampere meter is not sufficiently sensitive to be used as an indicator, and a 0-100 or 0-200 microampere meter or other sensitive device is required. The V-T. voltmeter section of channel testers is a convenient instrument for this purpose and may be connected across the "limiter grid" bias resistor. Marked R1, in Fig. 1, schematic diagram.

Misalignment of the R.F. section will cause noisy reception, multiple responses and a low signal/image ratio.

OSCILLATOR AND I.F. CIRCUITS

Oscillator troubles are much like those in A.M. receivers and may be caused by defective mixer tubes, poorly-soldered joints, open grid-leaks, etc. Oscillator grid current is generally between 100 and 500 microamperes. It is difficult to check gain in the

R.F. stage of F.M. receivers, because most signal generators have so much leakage that at 42 to 50 mc. gain measurements accurate enough to mean anything are difficult to obtain.

The I.F. systems of frequency modulation receivers may employ over-coupled transformers to give a band-width of 200 kc. In this case, the alignment procedure is as outlined below. Some receivers have looser-coupled I.F. coils, with no tendency toward a double peak, but broadened with resistors. This type of I.F. can be aligned by the conventional single-frequency method.

ALIGNMENT

Although it is most convenient to align the F.M. receiver with a frequency-modulated oscillator, a satisfactory job can also be done with an accurately-calibrated signal generator or oscillator covering a range in the vicinity of 2.1 mc. The object of alignment is to adjust the I.F. trimmers so that the I.F. system has a band-pass from 2.0 to 2.2 mc., and then to adjust the detector coil to cover exactly the same band.

Proceed as follows:

(1) Disconnect the mixer coil, ordinarily the center coil on the R.F. assembly, from its connection to the control-grid of the 6SA7 tube. This is point "C" on the circuit diagram.

(2) Connect the "hot" output terminal of the generator or oscillator to this grid, and the ground terminal to the chassis.

(3) Connect a 0-50 or 0-200 microampere meter in series with the ground end of the 0.1-meg. resistor, R1, which connects the black wire from the 3rd I.F. coil to ground. (In the case of the kit-type receiver which we are here using as an example for purposes of discussion.) This will measure the grid current of the 1852 limiter tube: 30 to 100 microamperes is all that should be expected at this point.

If a stage analyzer or an electronic voltmeter is available, it can be connected directly to the grid-return lead (black wire) of the same transformer without disconnecting the resistor. This measures the limiter grid bias voltage. A reading of 3 to 10 volts should be considered normal.

(4) Set the oscillator at 2,175 kc. and align the I.F. trimmers for maximum response. Then go over all trimmers and tighten (turn clockwise) them very slowly until, on each trimmer, a barely perceptible decrease in limiter grid current or bias voltage is noted.

Then adjust the oscillator dial to 2,025 kc. The grid current (or voltage) should be approximately the same as at 2,175 kc. If it is not, adjust the I.F. trimmers for maximum response, leaving them in the *loosest* position which will give this response. Then repeat the previous adjustment at 2,175 kc. The output should remain nearly the same when tuning between the 2 frequencies, and should begin to decrease on each side of the 2 frequencies. The approximate I.F. response curve is shown in Fig. 2.

(5) Remove the microammeter and re-connect the 0.1-meg. resistor as it was before.

(6) Connect the microammeter in series with the ground end of the 0.1-meg. resistor, R2, which joins the 2-meg. resistor in the detector load circuit to ground. A high-impedance electronic voltmeter, such as that in the Analyst or similar device, can be connected between the junction of the 0.1-meg. and the 2-meg. resistor and ground. (Point B.) This measures the detector output current or voltage.

(7) Adjust the test oscillator to 2,200 kc. Adjust both trimmers on the detector coil, I.F.T.4, for a peak. Re-adjust the oscillator to 2,000 kc. Reverse the connections to the microammeter or electronic voltmeter or read reversed voltages. Again adjust the 2 trimmers for a peak, turning them only a small amount one way or the other. Then slowly tune the oscillator to 2,100 kc.; the detector-output current or voltage should decrease. Carefully re-adjust the trimmer nearest the 6H6 tube until the current or voltage is zero. An insulated screwdriver is essential; this is an extremely important operation. Turning the oscillator dial one

Approximate I.F. response curve of F.M. receivers or adapters.

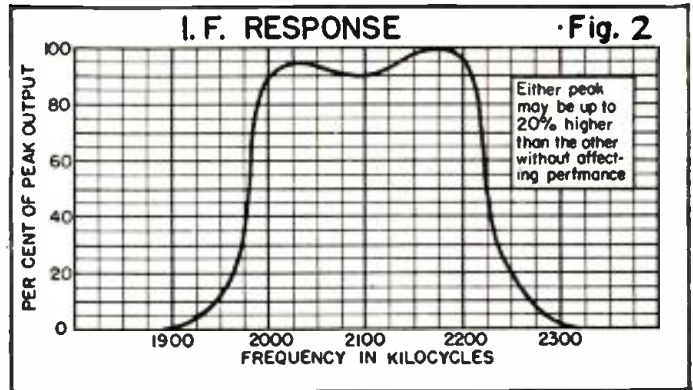

way should make the voltage *positive* and the other way *negative*.

Again set the oscillator to 2,200 kc. and adjust the trimmer nearest the 1852 tube for a peak. Repeat the previous operation of centering the zero reading on 2,100 kc. as was done with the other trimmer. This completes the alignment of the I.F. channel. Re-connect 0.1-meg. load resistor R2 to restore the circuit to its original condition. An approximate detector response curve is shown in Fig. 3.

(8) Re-connect the control-grid of the 6SA7 to the mixer coil and disconnect the generator from this point. (Point C.)

(9) Connect an antenna to the receiver and again prepare to measure the limiter grid current or voltage. (Operation 3.)

(10) Set the dial of the receiver to the frequency of any F.M. transmitter that is within receiving range. Now adjust the oscillator trimmer so that the received signal produces a current or voltage reading on the limiter grid. Then adjust the trimmers on the mixer and antenna coils for maximum reading at the limiter grid.

These trimmers should align rather loosely. If they are tightened so that the frequency of the R.F. circuit equals the oscillator frequency, spurious oscillations and responses are produced. The oscillator frequency is normally 2,100 kc. lower than the signal frequency. When the above adjustments are completed and the 0.1-meg. limiter grid load resistor is again grounded, the receiver has been aligned. Do not attempt to operate the F.M. receiver without an antenna.

CAUTIONS

Detuning of the discriminator coil can cause high noise level and distortion. To check this portion of the circuit, follow Operations 6 and 7, above. A crooked or poorly-shaped discriminator curve will surely introduce bad distortion. Open or off-rating resistors in the detector network can also cause trouble by making the detector curve unsymmetrical.

One of the most important points in I.F. alignment is to have the peak of the I.F. selectivity curve at the same frequency as the zero voltage point of the discriminator curve.

THE A.F. SYSTEM

The audio-frequency amplifier system, of the kit-set shown here, incidentally is much like that of conventional receivers. The exception is due to the fact that the detector output is at a uniformly high level, and very little audio gain is required. Advantage of this high gain is taken to introduce 6 to 10 db. of negative feedback, generally from the speaker voice coil to the cathode of the audio amplifier tube. (Conservatively rated, the power output of the A.F. channel shown in Fig. 1, dotted enclosure, is 6 watts, which is ample for home use.)

In the audio system is a so-called equalizing or de-emphasizing network consisting of a 0.1-meg. resistor and a condenser of 600 to 1,000 mmf. capacity.

This serves to compensate for the excess high frequencies introduced at the transmitter, and at the same time reduces high-frequency noise components in the received signal, against which the frequency modulation system is least effective. Excessive noise and distorted high-frequency reception may be caused by a defective resistor or condenser in this part of the circuit. The Tone Control in 2 of its positions provides bass boosting.

NOTE R: Referring to the main diagram, Fig. 1, the 400-ohm, 3-watt resistor indicated as Note R is connected in the receiver as shown. It must be removed and its connection points (P-P) joined together when the built-in audio system (see dotted enclosure) is installed.

A peculiar "blooming" noise developed in a receiver which was found to be caused by feedback from a long lead (from the audio circuit to the 6SC7) passing close to the control-grid of the 1st I.F. stage. Rearrangement of leads cured this trouble.

When properly aligned, the 3-plate oscillator tuning condenser is near maximum capacity. With an R.F. signal applied to the antenna terminal the discriminator curve appears on the oscilloscope with a positive slope (lower-left to upper-right). If now, the 3-plate condenser is turned in the direction of decreasing capacity, a reverse curve indicates an oscillator frequency 4.3 mc. *above* the R.F. rather than below as is correct. Furthermore, because of the attenuation of the R.F. circuits (to a frequency 4.3 mc. higher than the frequency to which they are adjusted) the sensitivity of the receiver will automatically rise and the curve will be made fuzzy by noise.

This article has been prepared from data supplied by courtesy of Meissner Mfg. Co.

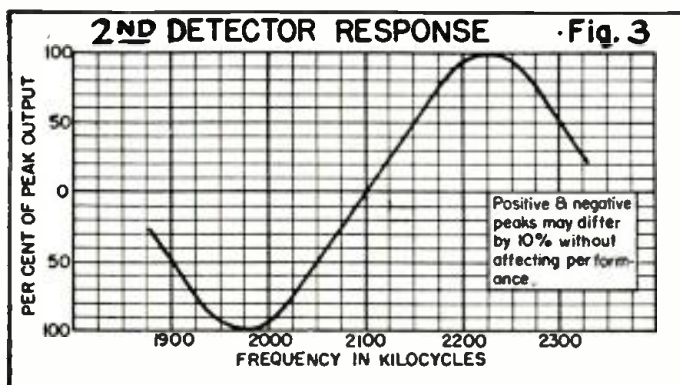

An approximate response curve for the detector circuit of an F.M. receiver.

STROMBERG-CARLSON MODEL 411 SERIES PHONO-RADIO

5-Tube Superhet.; Broadcast and Shortwave Bands (540 to 1,700 kc.; 5,800 to 18,000 kc.); Crystal Pickup; Sliderule-Type Dial; Iron-Core Coils; Electrodynamic Speaker; Automatic Bass Compensation.

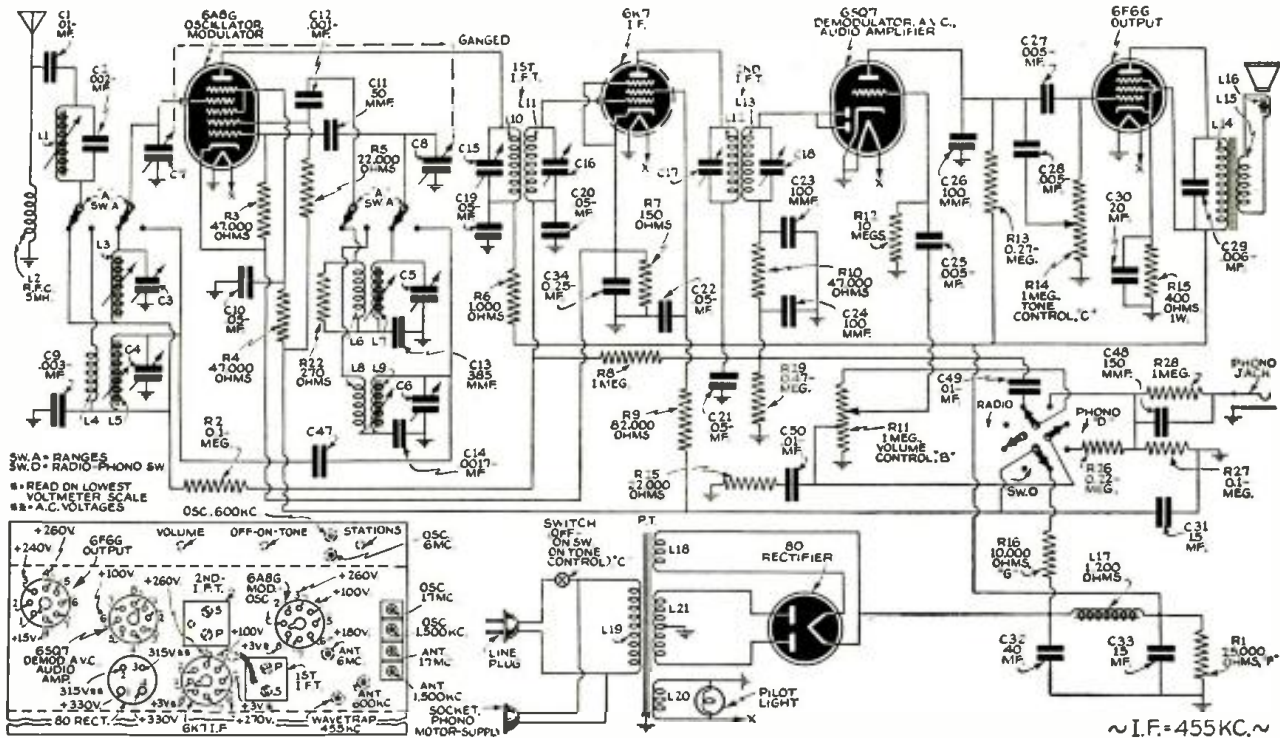

Schematic diagram and sketch showing location of trimmers and giving socket voltages.

ALIGNING INFORMATION

(Follow this order exactly)

Use a good modulated signal generator (test oscillator) with variable output voltage and a sensitive output meter across the voice coil of the speaker. Always use the smallest possible input from the signal generator (except when wavetrap adjustment is made). A strong signal makes adjustments inaccurate. Always have receiver volume control full-on. Never align with the tone control in "bass" position.

With the plates of the gang tuning condenser fully engaged, set the dial pointer directly on the vertical line located at the extreme low-frequency end of the shortwave band.

Intermediate frequency adjustments:
 (1) Set the range switch to Standard Broadcast position; (2) tune set to extreme low-frequency end of the dial; (3) connect the ground terminal of the signal generator to the ground terminal of the chassis; (4) in-

roduce a modulated signal of 455 kilocycles to the grid cap of the 6A8G tube, using a 0.1-mf. condenser in series with the output lead of the signal generator. (Do not remove the grid clip from this tube); (5) adjust the I.F. Aligners for maximum output in the following order: (a) secondary of 2nd I.F. transformer; (b) primary of 2nd I.F. transformer; (c) secondary of 1st I.F. transformer; (d) primary of 1st I.F. transformer.

Radio frequency adjustments.
 Shortwave Range (C Band)

(1) Replace the 0.1-mf. condenser in series with the output lead of the signal generator with a 400-ohm carbon-type resistor, and connect it to the antenna terminal of the chassis; (2) set the range switch to the shortwave range (C Band); (3) set the signal generator frequency and the receiver tuning dial to 6 megacycles; (4) adjust the 6-megacycle oscillator and antenna (iron cores) for maximum signal; (5) set the signal generator frequency and the receiver tuning dial to 17 megacycles; (6) adjust the 17-megacycle oscillator and antenna aligning condensers for maximum signal; (7) repeat operations 3 and 4; (8) repeat operations 5 and 6.

Standard Broadcast Range (A Band)
 (1) Replace the 400-ohm carbon type resistor in series with the output lead from the signal generator with a 200-mmf. condenser; (2) set the range switch to the Standard Broadcast Range (A Band); (3) set the signal generator frequency and the receiver tuning dial to 600 kc.; (4) adjust the 600-kc. oscillator and antenna (iron cores) for maximum signal; (5) set the signal generator frequency and the receiver tuning dial to

1,500 kc.; (6) adjust the 1,500-kc. oscillator and antenna aligning condensers for maximum signal; (7) repeat operations 3 and 4; (8) repeat operations 5 and 6.

Wavetrap adjustment.
 (Leave the receiver connected in the same manner as when adjusting the Standard Broadcast Range ["A" Band]).

(1) Tune set to 1,000 kc.; (2) set the signal generator frequency to 455 kc. and introduce a fairly strong modulated signal to the receiver; (3) adjust the wavetrap aligner for minimum signal.

NORMAL VOLTAGE READINGS

Take all readings with chassis operating and tuned to 1,000 kc.—no signal. Use a line voltage of 120 volts, or make allowance for the variation. Use a good high-resistance voltmeter having a resistance of at least 1,000 ohms per volt. Take all D.C. readings on the 500-volt scale except when an asterisk (*) appears. Read from indicated terminals to chassis base.

CONTINUITY TEST

CAUTION: Remove all tubes and disconnect the receiver from the power supply before making continuity test. Use a good meter capable of measuring accurately up to several megohms. The resistances given are often approximate, owing to electrolytic condensers in the circuit. When this is the case, be sure to reverse the test leads and read the highest resistance. Read from indicated terminals to chassis base unless otherwise specified. See location chart for position and numbering of terminals.

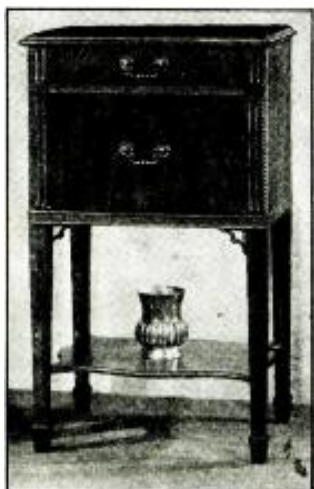

Stromberg-Carlson model 411-PF table model phono-radio.

Tube	(ap)	1	2	3	4	5	6	7	8
6A8G	1.5M	S	S	26,000 ^Ω	85,000 ^Ω	50,000 ^Ω	60,000 ^Ω	S	150 ^Ω
6K7	1.5M	S	S	25,000 ^Ω	110,000 ^Ω	150 ^Ω	35,000 ^Ω	S	150 ^Ω
6SQ7	—	S	10M	S	550,000 ^Ω	550,000 ^Ω	300,000 ^Ω	S	S
6F6G	—	S	S	25,000 ^Ω	25,000 ^Ω	1M	*	S	400 ^Ω
80	—	26,000 ^Ω	250 ^Ω	250 ^Ω	26,000 ^Ω	—	—	—	—

Symbols used on chart are as follows: ^Ω—ohms; M—megohms; S—short.
 *Tone control in "treble" position—1 megohm.
 Tone control in "bass" position—"short".
 Other Tests Not Shown on Chart
 Antenna terminal to chassis base—70 ohms.
 Ground terminal to chassis base—"short".
 Phono terminal to chassis base—500,000 ohms.
 Between terminals of A.C. plug: A.C. switch open—"open." A.C. switch closed—8 ohms. Terminals of A.C. plug to chassis base—"open". R.F. coil tests measured directly across R.F. coil terminals with range switch set in Standard Broadcast Position (A Range). L3—3 ohms; L4—"short"; L5—"short"; L6—0.5-ohm; L7—4 ohms; L8—0.1-ohm; L9—"short".

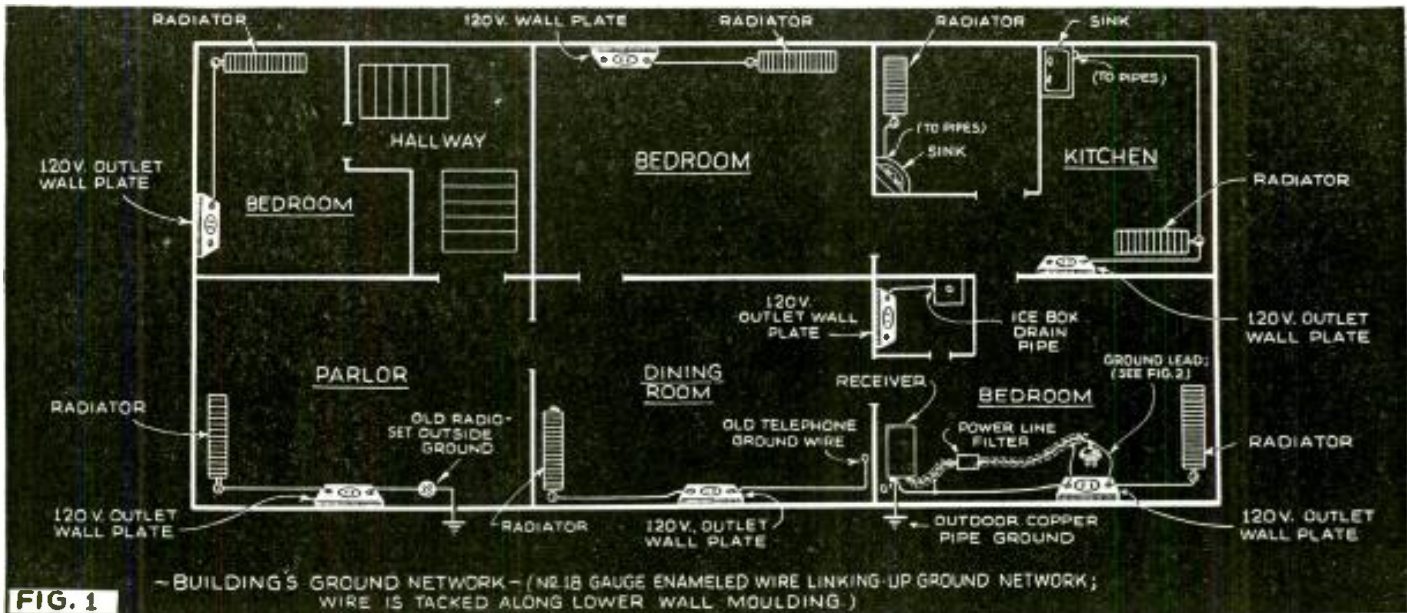

FIG. 1 - BUILDING'S GROUND NETWORK - (No. 18 GAUGE ENAMELED WIRE LINKING-UP GROUND NETWORK; WIRE IS TACKED ALONG LOWER WALL-MOULDING.)

THE GROUND

And Its Relation to Radio Interference

Articles concerning the ground and its relationship to interference problems have already been published, therefore this article analyzes only important, out-of-the-run reception problems and some new or little-stressed angles of this field. Familiar theory and phenomena are avoided as much as possible. Servicemen and set-owners alike will here find explanations of unusual performances, of broadcast and shortwave receivers, directly traceable to the grounding system.

TED POWELL



BEFORE proceeding, the reader must bear several general facts in mind in order to better understand what will follow later. No attempt to go into details will be made as books and articles on this field are available.

WHEN IS A GROUND?

In the first place, there is no such a thing as an "absolute ground." The term is more or less relative. What may be an efficient "ground" in a power system, for instance, might behave as a "counterpoise" or an inverted vertical antenna at radio frequencies! Any "grounded" conductor of appreciable length will have a potential gradient with respect to the earth below it because of the appreciable impedance it possesses at relatively high frequencies.

Even the earth itself is not a fixed or constant ground. The resistance of various areas and stratas of the earth's shell vary, and furthermore, variable potentials exist within it which cause circulating currents of various types to flow within its layers. Some are natural and others due to human agencies. Some are D.C., some A.C. and may be either purely conductive or electrolytic-ionic or a combination of these. The ionic type may have something to do with a little-understood type of interference known as "external" cross-modulation.

Then there are 4 factors that operate at high frequencies to make interference possible that must be carefully considered. They are: (1) electromagnetic radiation (antenna

effect); (2) inductive reactance (choke effect); (3) capacitative reactance (condenser effect); and, (4) impedance (total A.C. resistance).

These 4 factors increase in their effect with increase of frequency to such an extent that at ultra-shortwave frequencies a few inches of any conductor becomes an efficient antenna; short sections of a circuit behave as chokes; conductors located near each other and facing end-to-end or edgewise make effective condensers; and finally, the impedance effect increases to such an extent that no matter how short or massive conductors or circuit components are, they offer appreciable impedance to the currents flowing at these frequencies and as a result, potentials exist in all ground leads, shielding, conductors and circuit components. All these factors combine to produce a state of affairs at very high frequencies wherein such a thing as a "ground" does not exist, shielding and bypassing are mere paper terms and any conductor within or near an ultra-S.W. circuit is "hot," grounds or no grounds.

Two more factors must be considered in interference work. Both are rather infrequent and one is not yet completely understood. One is known as "tunable" hum and the other as "external" cross-modulation and some evidence points to the fact that they are related phenomena.

"Tunable" hum occurs when transmitter signals circulate in power lines and have a 60-cycle modulation impressed upon them by reason of circuit non-linearity existing in the power system (copper-oxide corroded

resistance joints and connections, etc.). These modulated signals get into the receiver circuits directly through the power pack and indirectly by reradiation in various ways.

"External" cross-modulation was at first thought to be caused by some sort of non-linear property of the propagation medium (the ether) or of the reflecting and refracting belts of ionized gases in the upper stratosphere (Heaviside layers). Later it was definitely determined that the presence of long transmission lines and metal structures in the receiver's locality was responsible. Oxide-corroded joints evidently produce the non-linearity (rectification) effects necessary for the detection-modulation-reradiation cycle.

It is possible that (a) ionic earth currents flowing between mineral deposits and corroded masses of metal, (b) electrolytic lightning arrestors in power line systems, and (c) electrolytic condensers and oxide corroded joints between shielding sections of the receiver itself, may also contribute to this effect.

INTERFERENCE PROBLEMS BRIEFED

To generalize briefly, when interference problems are to be solved, we must consider the radiation, conduction, capacity, induction, and reradiation coupling effects between the antenna, ground leads, power lines, telephone lines, building wiring, various metallic bodies in the receiver vicinity and the receiver itself; the added complication of tunable hum and external cross-modulation; the phase relationship between

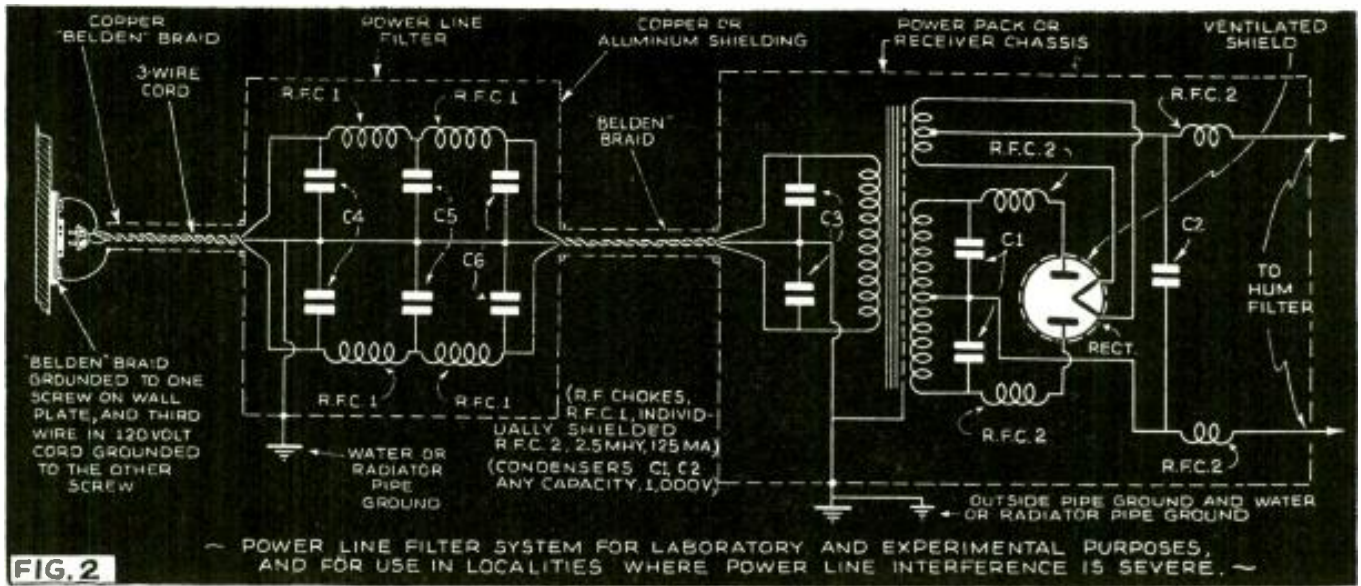

these factors; and finally, the possible combinations of these effects.

Of course not all interference problems present individually such a maze of complexity as described here. Most of these effects are normally negligible in their influence and may not even exist in any one locality. They are listed here in order that we may be in a better position to trace some elusive sources of interference that occasionally crop up under certain favorable conditions.

These various types of interference can be minimized or even totally eliminated by setting up an elaborate ground network within the building housing the receiver, carefully filtering the power line of R.F. signals, eliminating all corroded connections in receiver, ground, antenna and power line circuits, and finally, where practical, installing suitable standard filters directly at interference-producing electrical apparatus. Such a filtering and grounding system will be described later.

THEORY APPLIED TO CASES

We'll analyze some actual interference cases as encountered in service work to see just how standard theory can be applied to practical "static" elimination.

Problem: Intermittent Volume.—A customer complained that her receiver's volume kept changing abruptly and erratically with coincident static noises. A check-up of the receiver on the workbench revealed no circuit defects and the receiver behaved normally at the store!

A check-up at the customer's home, however, disclosed the following facts. The synchronized volume variations and static noises were evident when doors were slammed, furniture moved, and especially when the refrigerator was moved or its door slammed. A clue to the trouble was found when it was noticed that the symptoms were present to a lesser degree when the housewife placed her electric iron on the radiator in the kitchen.

An examination of the house wiring system revealed no loose "BX" or wiring connections. A careful search of piping systems and steam-heat radiators also proved fruitless. The ground, power and antenna leads to the receiver were also OK. Nearly 2 hours of searching and fussing about the house and the writer was just about ready to give up. Finally, when a pocket flashlight was beamed under the refrigerator, the gleam of scratched metal caught the

eye. A lead plate was sticking out from under the edge of the linoleum. It was part of a water drain system for the old ice-box that had no doubt previously stood in this corner. The metal leg of the refrigerator was resting against this plate and pipe combination.

The hardest part of the job was over. A short piece of enameled wire was run from the lead plate to the wall-plate of the 120-V. outlet feeding the refrigerator. A good water-pipe ground was run to the receiver. The trouble vanished. Had not the flashlight caught the scratch on the plate protruding from under the edge of the linoleum, the writer would have been "stuck."

The explanation was simple enough, once the trouble was found. The R.F. grounding in this apartment was practically nil. As a result, fairly strong R.F. signals were circulating in the 120-V. wiring and its "BX" armor. This was moving into the receiver via the power pack. The refrigerator's metallic leg made intermittent contact with the grounded drainpipe plate whenever building vibrations occurred. Because of the capacitive effect between the refrigerator's 120-V. wiring and its metallic frame, intermittent grounding (bypassing) of the R.F. signals flowing in the 120-V. house wiring occurred. Therefore the total R.F. input to the receiver was intermittent and the volume variations and coincident static rasps were present. Grounding the 120-V. outlet wall-plate to the drain plate permanently grounded the R.F. signals flowing in the powerline, the receiver's sole R.F. input then was the antenna, and so the trouble vanished.

Problem: Midget Set "Hummed."—A customer brought in a console-type midget complaining that it "hummed." It was assumed that the trouble was due to poor power supply filtering and a form of mild H.F. oscillation common to midgets because of the proximity of circuit parts and insufficiency of bypassing. Insertion of bypassing condensers and some shielding reduced the hum to a point where it was unnoticeable.

The owner returned with the receiver and, with a "you gyp, you" gleam in his eye, exclaimed that the set was "never fixed." The receiver was tried out at the store and it behaved very well, much to the man's embarrassment.

At the customer's home though it was found that the trouble was a form of tunable hum. Sufficient powerline filtering and

receiver grounding was added until the hum was reduced to a point where the owner was satisfied. Powerline connections were cleaned and tightened. A shield about the power rectifier tube helped in this case.

Problem: Indoor Antenna Performed Oddly.—In another case, a customer confided that his indoor antenna behaved "mighty funny." He explained that when it was run along the lower moulding of the wall, several large stations faded considerably. When it was run up the wall and across the ceiling, the volume came up but static rasps and volume variations became evident. This erratic volume variation and static was present to a slight extent when the antenna was located along the lower moulding.

The explanation given him was as follows:

Since his small apartment was located at the basement level of the building, his indoor antenna was partially screened-off from station signals by the steel girders and other metallic bodies within his building and those about him. As a result, most of the antenna's pick-up was by reradiation effects from the 120-V. house wiring and its poorly grounded "BX" armor. When the antenna was run up the wall and across the ceiling it was brought near to the power wires within the walls and picked-up their R.F. signals. When building vibrations occurred, make-and-break contact between "BX" armor and steel beams within the walls, and between junctions of sloppily-assembled cable runs and junction boxes, occurred. This produced a variation of signal input to the antenna and the volume variations and static rasps. When the antenna was laid along the lower moulding it ran along a steel I-beam within the walls and so was screened-off from several large stations to the west. This caused the fading-away of these stations.

A short, outside, courtyard antenna and a radiator pipe ground gave him fairly good reception.

Problem: External Cross-Modulation.—The writer can recall only one case within his limited service experience where he had cause to suspect "external cross-modulation" interference. The building housing the receiver was located next to a factory district. A stagnant canal ran past the factories and coal yards.

When any of the local part-time stations came on the air, and power-line disturbances and fluctuations were severest (5 to 7 P.M.),

NOW IT CAN BE TOLD!

P.A.—BIG NEW SECTION

Featuring 3 complete lines. Now a Lafayette streamlined Sound System for every purse and purpose. Here's stand-out P.A. styling, years-ahead engineering, matchless performance and value. Everything to go with the modern sound system, everything priced bedrock low. Read about Lafayette's sensational 30-day Free Trial and Time Payment Plan.

64 NEW MODELS

Lafayette's 1940 challenge to the radio world: 64 brilliant new models—each tops in its class for style, performance and value. Portables, table models, consoles, phono-combinations—every radio type for home, farm, camp and car. 5 to 15 tube sensations. Consumer Test laboratories consistently vote Lafayette "Best Buy."

LATEST HAM EQUIPMENT

Long "ham" headquarters, Lafayette shows the reason why in this great catalog's Amateur Radio section. See the latest receivers, plus a complete line of ham equipment—all nationally advertised and here at real money-saving prices.

AND RADIO PARTS

Thousands of items, many hard-to-get today. All the famous names are in this great book that saves you money on everything you buy! Latest type tubes, test equipment, FM and standard Build-it-Yourself Kits. Tools, too, and instruction books to make radio easy. Special section on new Fluorescent Lighting.

MAIL THE COUPON NOW

Be among the first to have and enjoy a free copy of Lafayette's latest catalog . . . they'll go fast for this one tops 'em all. You'll prize this new Fall catalog—for the information and values it contains, take our word for that. So why delay—tear out and mail the coupon at once.

The book is
FREE

Lafayette Radio

NEW YORK, N. Y.
100 Sixth Ave.
CHICAGO, ILL.
901 W. Jackson Blvd.
ATLANTA, GA.
265 Peachtree Street
BOSTON, MASS.
BRONX, N. Y.
NEWARK, N. J.
JAMAICA, L. I.

NEWS OF LAFAYETTE'S LATEST, GREATEST, FREE Catalog

THE BOOK WITH 196 PAGES
OF RADIO VALUES!

There never was a catalog like this before. Months in preparation . . . complete to the tiniest accessory . . . outstanding in value-giving, it's a money-saving book for Servicemen, Experimenters, P. A. Specialists, Amateurs—anyone and everyone connected with Radio or Public Address. And it's yours absolutely FREE!

BIGGER IN EVERYTHING

No phase of Radio, no worthy manufacturer has been overlooked in compiling Lafayette's latest and greatest catalog to date. Into it has been poured the experience of over twenty years . . . experience reflected not only in the tremendous selection of parts and equipment, in the thoughtful arrangement of these thousands of items for easy, time-saving reference but also in the low prices of recognized quality merchandise. Prices that cannot be matched anywhere today. When you study this book, aware of its bigness . . . its completeness, there is no denying that its contents—radios, parts, ham equipment, test equipment, Sound Systems—are bigger in value.

SAVES YOU REAL MONEY

Check this catalog's prices for proof of real savings, no matter what item you may be considering. And remember, this book offers all the nationally advertised parts and equipment. Remember also, Lafayette delivers direct to your door, adding a saving in time to a very worthwhile saving in money.

LAFAYETTE WILL NOT BE UNDERSOLD

20th
ANNIVERSARY

LAFAYETTE RADIO CORP.

DEPT. 3K—100 SIXTH AVE., NEW YORK, N. Y.
or 901 W. JACKSON BLVD., CHICAGO, ILL.
Please Rush FREE Catalog No. 82.

NAME

ADDRESS

CITY

STATE

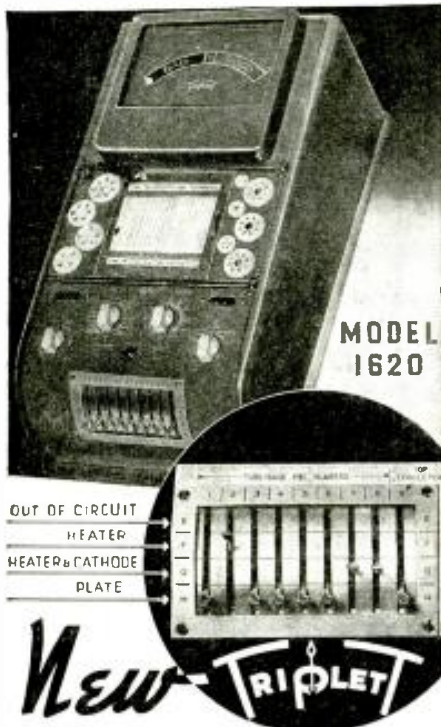

LEVER SWITCHING

Combining simplicity of operation with absolute flexibility, Triplet's new lever switching permits individual control for each tube element—yet test procedure is simple and quick. The switch setting shown above will permit tests of 45 commonly used different type tubes without change of positions of the levels. Many tubes require only two lever switch settings—more than half, only three settings.

This revolutionary lever switching development, with individual control for each tube element, takes care of roaming filaments, tapped filaments, plural cathode structures and dual function tubes—conclusively checks all present receiving tubes including Miniatures, Bantam, Jr., and the new Midgets. Neon shorts test and noise test jack included.

Model 1620 also features four additional "quick change" non-obsolescent features, including the above switching section. RED • DOT Lifetime Guaranteed Instrument panel may be returned for replacement or repairs, in case of accidental damage . . . Speed Roll Chart complete with mechanism can be replaced, in the case of new factory releases, by removing only four screws from front of panel . . . New socket panel to meet future radical tube changes which present spare socket cannot accommodate will be available at nominal charge upon return of old panel . . . Switching section with power supply also can be replaced should unanticipated changes make it necessary. Gracefully proportioned wood case, natural finish. Beautiful two-tone Brown-tan sloping panel; polished metal chrome trim with inlaid color. Model 1620 Counter Tube Tester. . . Dealer Net Price . . . \$37.84.

Write for Catalog—Sec. 1610 Harmon Drive



the interference became most troublesome. When long barrages of powerline static came in, the cross-modulation "rode in" on it. At first, ordinary receiver cross-modulation was suspected. A test on the workbench proved the receiver to be as innocent of guilt as a new-born babe.

It was then decided that the cross-modulation was external. Since the 110-V. house wiring connections were not soldered, they were all broken open, cleaned carefully and soldered up. This was also done with the antenna and ground leads. Elaborate grounding and powerline filtering was resorted to.

The results were disappointing. The cross-modulation effects were only reduced slightly, although hum and static were noticeably cut down. The writer decided that since this was a factory district with a maze of power and telephone lines, earth wet from a nearby canal, masses of corroded metal, etc., the case was pretty hopeless. External conditions were the dominant factors here and little or nothing could be done within the building itself to eliminate the trouble. Nothing short of a totalitarian air raid upon the factory district would change things to any extent.

UNORTHODOX RECEPTION CASES

The following cases are not exactly interference problems but serve to illustrate how a grasp of what has been presented so far can be applied to the analysis of unusual reception conditions. These are rather amusing instances of where amateurs have implied that they have proven accepted radio theory to be false.

Effect: Phenomenal Long-Distance Reception.—In one case, a "DX" fan living in a fairly large apartment building in a suburban town, had obtained permission from his building superintendent to run a vertical antenna up the skylight shaftway that ran down about the center of the building. He claimed to have received distant stations "just like locals" under these unfavorable conditions.

Upon examining his list, it was found that it consisted of a score of medium and high-power stations, most of whose frequencies lay at about 1,100 kc. He talked of the unusual results that he had obtained with these particular stations *but said nothing about the poor results he no doubt had obtained throughout the rest of the broadcast band.* In this one fact we have the answer to the apparently paradoxical reception of distant stations under such adverse conditions.

What probably occurred here, was a case of "tuned reradiation." The maze of vertical steel girders within the building walls surrounding the shaft had such R.F. constants as to have a resonant frequency of about 1,100 kc. Therefore, they "tuned" to station signals of about this frequency, and rebroadcast them to the antenna running up between them. Some of these girders might have acted as "director" arrays and concentrated the signals upon the antenna by reflection.

Effect: Ground Seemingly Unnecessary.—In another case, a set owner told of how he had erected an aerial only a few feet off the ground and had obtained better results than with standard-height antennas. In fact, he "didn't even need a ground."

The conditions about his home were looked over and the reason for this unorthodox behavior was fairly obvious. A railroad ran past his back yard. A power transmission line followed this railroad right-of-way. In front of his home on the opposite side of the street was a row of telephone poles with their power and telephone lines.

When this man had erected his standard-

height antennas, they lay on about a level with the 2 sets of transmission lines. In this way the antennas were partially screened-off from signals in nearly all directions. In other words, they were parked in a "shadow."

In erecting a *very low* antenna, he had accidentally found a solution to his difficulties by locating it below this shadow. Had it been possible for him to erect a *very high* antenna he would have secured much better results because he would then have an effective antenna that would have been located above the screening lines.

He had a ground but didn't know it. The 120-V. lines in his house supplied the grounding, or rather, a *counterpoise system*, since he was located on the 3rd floor.

Anyone doubting the existence of such shadows has only to turn on his auto-radio receiver and drive his car past or under a steel structure to have his doubts dispelled.

Effect: Ground is Aerial, and vice-versa.—A common stunt pulled by some inventive set owners is to switch around the antenna and ground leads of their receivers and then challenge their technically-minded friends to explain away this "unorthodox paradox."

The answer to this question is much simpler than they might suspect. The sorry affairs they refer to as "grounds" are in reality *high-impedance grounds*, or in reality no grounds at all as far as R.F. signals are concerned. What they actually have is a mediocre aerial and a "loaded" counterpoise antenna. In switching around they merely take 2 bits from their coat pocket and drop it into a vest pocket.

We could go on like this almost indefinitely. Enough examples have been presented to illustrate the soundness of the standard theory used here.

THE GROUND AND FILTER SYSTEM WITHIN THE BUILDING

In Fig. 1 is shown the elaborate ground and filter system as used by the writer and is recommended where interference conditions are severe, particularly where power lines are the principal offenders.

Figure 2 shows the power line filter circuit in detail. The filter action is continued right up to the power pack. This filter network employs all the tricks in the books—and a few more besides—in order to prevent powerline signals from getting into the power pack. Of course, where practical, suitable standard filter units should be installed directly at interference-producing electrical apparatus within the building or neighborhood. The nature of static-generating units is familiar enough to obviate the necessity for explanations.

This system is not claimed to be a magical cure-all but is an aid to the suppression of interference.

The Outside Ground.—We'll begin with the *outside ground* and work back to the receiver chassis, analyzing each filter and ground circuit as we meet it.

An outdoor ground is not always a practical proposition and in some cases an impossibility. Where possible, one should be driven into the earth.

Power engineers have found from experience that the most efficient ground for a given expenditure of material is the sunken vertical pipe ground. The general practice is to sink several 6 foot, or better, lengths of tinned copper pipe into the earth, in a damp or flooded spot if possible. The tinning helps to inhibit corrosion.

Where the earth is dry and sandy, or of any other type that is a poor electrical conductor, various methods of "doping" the earth about the ground piping is resorted-to (water, coke, ashes, salt, chemicals, etc.).

This doping shortens the useful life of the piping because of the chemical reactions that inevitably result, but the effectiveness of the grounding is greatly increased for the 2- or 3-year period before crippling by corrosion occurs.

Before the piping is driven into the earth, it is advisable to obtain a print of the piping feeding the building. The ground or grounds should be driven into a spot away from the general center of the pipe system under the building so as to get it away from the circulating ground-currents that may be flowing between them. Care must be taken not to work directly over a pipe line otherwise a broken main stem might be the result. Where possible, buried bare copper wire leads can be run from the pipe grounds and buried into tree trunks, buried masses of metal, ponds, lakes, cesspools, etc.

Number 14 to 18 gauge single-strand enameled wire leads are bolted or riveted to the ground pipes, the joints soldered with a small torch, and taped and painted over with some sort of pitch or asphalt paint. This is done to prevent trouble-making oxide-corroded joints from forming. The wire lead or leads are run up the building wall directly to the receiver chassis.

The writer ran a 3/4-in. copper pipe up to the window ledge outside the room housing the receiver. Chemicals were poured down the pipe to increase the conductivity of the earth at the bottom of the pipe.

The Inside Ground.—Within the building itself, No. 18 gauge enameled wire leads are run between the 120-V. outlet plates, and the radiator and water pipes in all of the rooms. Where practical, water pipes, steel beams, old ground wires, etc., should be included in the ground network. The leads are run along the lower wall mouldings.

(The wall-plates of the 120-V. outlets, make contact with the small junction box behind it, which in turn make contact with the grounded "BX" armor of the power leads.) This grounding is usually sufficient when carried out in the room where the receiver is located.

In the case of severe interference troubles and shortwave and ultra-shortwave work, it is worth while to carry out this grounding throughout the whole house. The grounding reduces H.F. impedances and increases eddy-current losses in the ground network in the building, and so reduces reradiation effects. This multiple paralleling also produces a much more effective ground for the receiver, an important consideration in "DX" work (or transmission, if the experimenter is a "ham").

Where the powerline enters the building we have a pair of 1- or 2-mf. condensers in series with fuses and shunted across the 240-volt leads if both are present in the building. The center-tap between them is connected to the powerline center-tap ground at the water pipe. If the "BX" armor is not already well grounded, make a good one to the water pipe. If the building is small and only a pair of power leads enter the basement (one is an outside 240-V. lead and the other the grounded C.T.), simply shunt 1 condenser across the 120-V. leads. If any of the power company's grounds look poor, do not tamper with them, but simply add your own grounds. (Personal injury to hands or eyes may be the result if the powerline neutral is opened when there is a load on the 3-wire system.) These condensers will tend to bypass R.F. signals circulating in the power lines.

POWERLINE FILTER

Between the receiver and the outlet feeding its power pack is a 3-wire filter and bypass system as used by the writer. It is admittedly over-elaborate, but was found

BUY DIRECT FROM THE MANUFACTURER AND SAVE

ANNOUNCING FOR THE FIRST TIME—THE NEW

DYNAROMETER

FEATURES NEW GIANT 8 1/2" DOUBLE JEWELLED METER

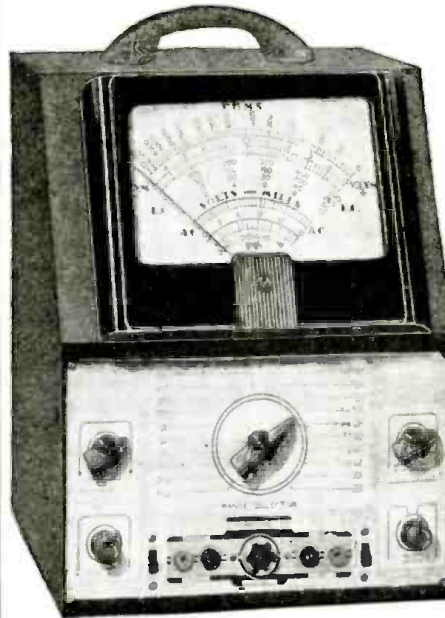

This amazing versatile instrument is our answer to the demands of radio-tricians for a combination instrument which, in addition to making the usual V.O.M. measurements, will also permit DYNAMIC D.C. VOLTAGE MEASUREMENTS without interfering with or upsetting delicately balanced circuits, such as tuned circuits, electronic apparatus, control voltages, etc. Actually, as you will note from the specifications listed below, the DYNAROMETER is a combination Vacuum-Tube Voltmeter and V.O.M. besides permitting additional measurements such as Capacity, Decibels, Inductance, etc. All calibrations printed in large, easy reading type on the giant 8 1/2" double jewelled meter. The Input Impedance for the V.T.V.M. is 11,000,000 ohms with 2,000,000 ohms per volt on the lowest range. The 4 V.T.V.M. ranges are 5, 25, 100 and 500 Volts, and because of the zero center no attention need be paid to polarity since the meter will read either in the plus or minus direction, depending on the position of the probes. This eliminates the danger of the needle back-firing off scale.

HAVE YOU EVER—

Tried to measure Control Voltages such as A.V.C., A.F.C., oscillator, etc.? Impossible with the ordinary V.O.M. due to loading of the circuit BUT the 11 megohm input impedance of the DYNAROMETER enables measurements without molestation at any point in the receiver.

Tried to locate distortion in the audio section of a receiver? A long tedious job with the ordinary V.O.M. but almost instantaneous with this new DYNAMIC method of testing.

Tried to isolate the cause of trouble in an intermittent job? Not only is this possible with the DYNAROMETER, but because of the extreme sensitivity and flexibility measurements are possible at points usually impractical with a V.O.M.

SPECIFICATIONS:

- 4 D.C. VOLT RANGES AT 11 MEGOHMS INPUT RESISTANCE: 0-5/25/100/500 Volts
- D.C. VOLTAGE MEASUREMENTS IN 5 RANGES: (at 1000 ohms per volt) 0-10/50/250/500/5000 Volts
- A.C. VOLTAGE MEASUREMENTS IN 4 RANGES: (at approximately 800 ohms per volt) 0-15/150/1500/3000 Volts
- RESISTANCE MEASUREMENTS IN 3 RANGES: 0-1000 Ohms
- 0-10,000 Ohms
- 0-30 Megohms
- D.C. CURRENT MEASUREMENTS IN 4 RANGES: 0-1/10/100 Ma.-0-1/10 Amp.
- 4 OUTPUT RANGES: 0-15/150/1500/3000 volts.
- 2 CAPACITY RANGES: .0005-1 mfd. .05-100 mfd.
- INDUCTANCE: 1 H.-70 H. 7 H.-10,000 H.

The Dynarometer operates on 90-120 Volts 60 cycles A.C. Comes complete with test leads and all necessary instructions. Shipping weight 20 lbs. Size 13 1/2" x 10" x 8 1/4". Our net price. **\$18⁷⁵**

SUPERIOR INSTRUMENTS CO. 136 LIBERTY ST., Dept. RC10 NEW YORK, N. Y.

to be worthwhile in shortwave and "DX" work, and where experimental work with cathode-ray and oscillator equipment was being conducted. It is intended to suppress power line H.F. signals and prevent them from reaching the circuits being protected.

The condenser-choke combination installed between the receiver power pack and the 120-volt outlet is nothing new. The condensers may be anything from 0.01-mf. to 2 mf.; and the chokes, 10 to 30 turns of enameled No. 14 wire wound on forms of 1 to 2 inches in diameter.

By inserting a commercial interference analyzer in series with the power line, the proper combination of chokes and condensers to suppress the particular type of interference existing at any particular location can be found. By referring to standard coil winding charts, the number of turns necessary and the requisite condenser capac-

A NEW BOOK ON AUTO RADIO
See Page 230

Simplest WAY TO REPLACE BALLASTS

4 STANDARD TYPES of Amperite Regulators replace over 200 types of AC/DC Ballast Tubes now in use. . . Has patented automatic starting resistor. List \$1.00

WRITE FOR REPLACEMENT CHART "S" Amperite Co. 561 Broadway, N. Y. C.

AMPERITE

"MARVELOUS, ME EYE!", SAID PROFESSOR OSWALD SQUEEGEE

PROFESSOR OSWALD Z. SQUEEGEE, Ph.D., ABC, PDQ., etc., turned an austere eye on the eager, upturned faces of his class in industrial engineering. Then, in the simple dignity becoming to a great man (which everyone, including himself, admitted he was) the Professor spoke:

"Listen, you dimwits," he thundered. "If there's one thing I want to pound through your thick skulls, it's simply this: The easiest way of doing any job is generally the complicated way. The hardest way is to keep plugging along until you've developed the simple way. That takes time. It takes patience and—ahem!—it takes brains."

Here the Professor paused, reached for the glass of water on his desk, got the ink by mistake, and sipped it calmly. Then he cleared his throat and continued:

"Some of the world's greatest inventions have been so simple that everyone wondered why Noah hadn't thought of them while he was sitting in the Ark.

"What, for instance, was more logical than putting an eraser on the end of a pencil? What was more logical than the safety razor? What was more logical than, instead of making nuts to fit the wrench, to make the monkey fit the nuts. I mean—ahem—the monkey wrench."

Fishing through the pile of notebooks, overshoes and chewing gum wrappers on his desk, Professor Squeegee found a Sprague Koolohm Resistor and held it up for his class to see.

"Now here is a practical example of simplified improvement," he bellowed. "One of

you clucks brought this resistor in and told me how marvelous it was.

"Marvelous, me eye! The only thing marvelous is that some resistor manufacturer didn't do it sooner—that it took a condenser manufacturer to figure out how much simpler it would be to insulate the wire itself, instead of trying to insulate the resistor after it is wound without shorting a lot of turns, or without having a coating that will crack, chip or maybe even peel like a banana. Now hand me that crowbar and cold chisel and I'll show you something real."



After 15 minutes' hard work and 3 skinned knuckles, the Professor pried the outer ceramic shell off the Koolohm.

"There it is," he beamed, "a practical example of a little simple simplification that meant a whale of a big improvement. Larger wire. No danger of shorted turns. More resistance in less space. So moisture-proof a duck's back would turn green with envy. So well designed it runs cooler than any other resistor of equal size and rating. The only resistor with an automatic overload indicator, and the first..."

Just then the 'phone rang. It was the Professor's wife telling him he was already three hours late for lunch. Without even waiting to bid his class goodbye, he laid a handkerchief carefully on his head, crammed his hat into a pocket, shut the door and walked calmly out through the open window.

SPRAGUE PRODUCTS COMPANY
North Adams, Mass.

P.S.—See Koolohms at your Sprague jobber's. Free catalog on request.

ities can be calculated. Otherwise trial and error methods must be resorted to. This unit must be carefully shielded as a unit by itself in order to prevent it from broadcasting the static to the receiver or nearby metallic bodies which can in turn reradiate it to the receiver.

In the case where tunable modulation hum or external cross-modulation effects are present, the general bypassing and grounding must be very thorough. Furthermore, if the connections in the building 120-volt wiring are not soldered, they must be broken open, carefully cleaned, hot-soldered and re-taped. All antenna and ground connections should also be gone over. Where terminals and terminal blocks exist, connections should be cleaned, tightened and smeared with a light coat of vaseline. Mechanical connections between "BX" armor and boxes, if loose, should be tightened. All this is done to eliminate loose and corroded joints with their attendant rectification trouble-making effects.

While work is being done on the 120-V. system, fuses and switches should be pulled, in order to kill the circuits to prevent possible injury to the hands and eyes from arcs and molten metal generated by accidental shorts.

GROUNDING WITHIN THE RECEIVER

This part of the ground system has a greater bearing upon receiver performance than on interference elimination. Still, it is worthwhile considering.

In each amplifier stage all ground-return leads should be run back "home" directly to the grounded end of the tube's cathode lead instead of being connected indiscriminately about the chassis. This prevents intra-stage chassis currents from criss-crossing each other and so helps reduce inter-stage coupling and increases stability slightly. It also reduces or eliminates the lengths of exposed chassis currents and therefore slightly reduces the pick-up effect of the chassis.

It is also worthwhile to make all necessary ground connections to the large, flat top of the chassis, so that whatever chassis currents do flow, do not have to flow around bends, corners or edges. This will slightly lower the impedances of the ground-return circuits of the receiver.

All permanent shielding sections should be soldered along all edges making contact with other permanent sections or the chassis. This will reduce R.F. impedances and increase eddy current losses and so increase shielding efficiency.

Where interference conditions are severe, the receiver chassis should be "canned" in aluminum or copper shielding in "pro" style to reduce chassis pick-up. Ventilation louvers are necessary to keep temperatures down within reasonable limits.

Where the experimenter is constructing his own circuits, he will find it a worthwhile investment to shield all the tubes in the receiver. Where power amplifiers and rectifiers are concerned, larger and better ventilated shields are necessary because of the greater heat dissipation of these tubes.

If any reader thinks this to be a waste of shielding, he has only to disconnect the loudspeaker from the receiver, dangle the leads of a set of earphones between the power amplifier tubes and listen to the program that the receiver is tuned to.

While on the subject of receivers, the writer might add here that while working with very-low-gain, high-power, high-fidelity audio systems, he has found that T.R.F. circuits and low-gain audio amplifiers definitely do produce receivers with high signal-to-noise ratios. Many distant stations can be listened-to with comfort, and can be recognized as such only by slight static hiss and fading

Three new low-priced SERVICE MANUALS

1 DIAGRAMS OF MOST-OFTEN SERVICED RADIOS

In a single manual you have all the radio diagrams most often needed today. Better than 4 out of 5 sets you service are included. These important, hint-giving, trouble-shooting circuits make your job easier, permit faster and better repairs. Let this new diagram manual guide you to real time-saving and money-making radio work. No need to work blindly, get your copy of this "on-the-job" handbook of useful diagrams, service hints, alignment data, parts lists, etc. 54 manufacturers, 473 models. 244 pages, large size 8½ x 11 in. Post-paid, only **\$1.95**

2 MOST POPULAR 1940 DIAGRAMS

Let this new manual give you (1) over 80% of all 1940 circuits ever needed, (2) acquaint you with recent radio developments, and (3) teach you how to service quickly and efficiently millions of sets sold last year. Includes service information on new portables, television, frequency modulation, signal tracing, amplifiers, recording, etc. Will pay for itself on the very first job. 212 pages, 8½ x 11 inches. Price only... **\$1.50**

3 Motorola SERVICE MANUAL

This up-to-the-minute manual will tell you how to repair every MOTOROLA auto radio. Includes detail schematics, service notes, alignment data, and parts lists for all of the 72 models made to date. Will repay for itself on the very first job. This large, 8¼ x 11 inch, 100-page manual is delivered to your home for only... **\$1.00**

FREE EXAMINATION COUPON

SUPREME PUBLICATIONS
3727 West 13th St., Chicago, Ill.

Rush the manuals checked below:

- 1. Most-Often Serviced Radios @ \$1.95
- 2. Most Popular 1940 Diagrams @ \$1.50
- 3. Motorola Service Manual @ \$1.00

I am enclosing \$..... send postpaid.
 Ship C.O.D., I will pay postman.

I must be satisfied, or my money will be refunded.

NAME:

ADDRESS:145

BIG BOY

MODEL 860

Performance... Eye Appeal... Value...
Sensationally Priced at **\$17.85**
Dealer Net Price

Here is an AC-DC Volt-Ohm-Milliammeter with all the ranges you want... easily readable on the large 7" instrument with extra-long 6" scale, in a new up-to-the-minute three-tone case. DC Volts 0-10-50-250-500-1000 at 5000 ohms per volt DC; 1000 ohms per volt AC; Volts 0-10-50-250-1000 at 400 ohms per volt; DC Ma. 0-1-10-100; Resistance ranges; 0-1500 Low Ohms; 0-750,000 Ohms and 0-7.5 and 0-15 Megohms. Maroon case with cream panel, attached handle... Dealer Net Price \$17.85

For Catalog Write—Section 1016 College Ave.,
READRITE METER WORKS, Bluffton, Ohio

effects, when such a circuit combination is used. Use of the doublet-type antenna is strongly recommended.

CHECKING THE ANTENNA GROUND SYSTEM

Before concluding this article, the writer would like to caution the reader to make certain that he is making a fair test on any changes or additions that he makes on the antenna or ground circuits before passing judgment on them. To simply tune-in a local station in the daytime and use this for an aural check on such changes is a highly inadequate test.

The thing to do is to tune-in a distant station at the high-frequency end of the dial at night and then make the changes and note the results. Under these conditions, making and breaking of various grounds to the receiver will result in corresponding static crashes in the loudspeaker, slight changes in volume and sometimes in the hum modulation of the signal, and possibly, slight changes in interference input. In this way the "DX" fan, Serviceman or experimenter can make changes with some certainty.

Another thing that must be borne in mind, is the fact that R.F. constants of the 1st R.F. stage are altered when changes in the ground or antenna circuits are made. Therefore, where we have ganged tuning condenser assemblies, the trimmer condenser of the 1st R.F. stage must be adjusted for each change made and the receiver must be carefully retuned to the stationsignal. This applies particularly to the standard "T" or "L" antennas.

The "Regenerative Detector" Antenna—Ground Test.—An effective stunt to work here is to mount a simple regenerative detector circuit anywhere on the receiver chassis, connect the antennas and grounds to be checked to it, power the detector from the receiver, connect it to the receiver audio system, tune-in whatever higher-frequency distant station can be pulled-in, detune slightly so that a heterodyne whistle is heard, then go about making changes in the ground or antenna circuits, each time tuning-in the station signal accurately to check the effects of changes made. This is a very sensitive method of checking antenna-ground combinations and should be of interest to "DX" fans and "listening post" operators.

This test brings to light a rather disconcerting effect. When a lead is run from a water-pipe ground to a radiator-pipe ground, or from a 120-V. wall outlet to a radiator pipe, etc., a change in the pitch of the heterodyning whistle is heard. By simply shunting any 2 or more grounds anywhere in the building, the tuning of an oscillating detector is altered in another part of the building—a circuit, by the way, which already has its own ground!

The "Headphone" Antenna—Ground Test.—Another method of checking grounds is to use a sensitive pair of headphones in shunt style across various grounds and ground connections. Wherever potential gradients exist or impedance joints occur, a hum or static noises will be heard. (Motors will produce a musical whine, etc.) These sounds disappear or fade when grounds are linked-up or poor joints corrected. This shows the necessity for linking-up the grounds into a network.

Where power lines grounds are being checked for good contact, it will usually be found that if a lead of the phones is clipped to the ground wire itself and the other lead clipped to the pipe to which it is strapped, a hum will be heard, and if motors are running in the building, musical whines will also be heard. Upon soldering up the joint, the noises will disappear. *If connections can have such high impedance to power and*

BUY DIRECT FROM THE MANUFACTURER AND SAVE

**THE NEW MODEL 1240
TUBE TESTER**

- Instantaneous Snap Switches Reduce Actual Testing Time to Absolute Minimum
- Tests All Tubes 1.4 to 117 Volts
- Sockets for All Tubes—No Adapters

Superior is proud to offer the newest and most practical tube tester ever designed. Unbelievably low in price—unbelievably high in performance.

- ★ Tests all tubes, 1.1 to 117 Volts, including 4, 5, 6, 7, 7L, octals, loctals, Bantam Jr., Peanut, single ended, float ing filament, Mercury Vapor Rectifiers, the new 8 series. In fact, every tube designed to date.
- ★ Spare socket included on front panel for any future tubes.
- ★ Tests by the well-established emission method for tube quality directly read on the GOOD ? BAD scale of the meter.
- ★ Jewel protected neon.
- ★ Tests shorts and leakages up to 2 meg-ohms in all tubes.
- ★ Tests leakages and shorts in all elements AGAINST all elements in all tubes.
- ★ Tests BOTH plates in rectifiers.
- ★ Tests individual sections such as diodes, triodes, pentodes, etc., in multi-purpose tubes.
- ★ Latest type voltage regulator.
- ★ Features an attractive etched aluminum panel.
- ★ Works on 90 to 125 volts 60 cycles A.C.

Model 1240 comes complete with instructions and tabular data for every known type of receiving tube. Shipping weight 12 pounds. Size 6" x 7½" x 10¾". Our Net Price.....

PORTABLE COVER \$1.00 ADDITIONAL

\$1185



**THE NEW MODEL 1220
POCKET LABORATORY**

- ★ Weighs Only 28 Ounces!!
- ★ Uses a 2% Accurate 0-200 Microammeter—Enabling Measurements at 5000 OHMS PER VOLT SPECIFICATIONS

- ★ 6 D.C. Voltage Ranges: 0-3-10-50-250-500-5,000 volts.
- ★ 3 A.C. Voltage Ranges: 0-15-150-1500 volts
- ★ 4 Resistance Ranges: 0-3000 ohms, with 15-ohm center, direct reading to 0.2 ohm; foregoing base range multiplied by 10, by 100 and by 1,000, to read up to 3 Meg. with self-contained 3 V. flashlight battery.
- ★ 4 D.C. Current Ranges: 0-200 microamperes; 0-2-20-200 Milliamperes, using wire-wound shunts.
- ★ 3 Output Meter Ranges: Same as A.C. Voltage Ranges.
- ★ 3 Decibel Ranges: From -2 to +58 D.B., based on .006 watt in 500 ohms.

Uses full-sized 3" square 0-200 microammeter, with 2% accuracy and finely damped movement, contained in a handsomely-designed, square molded Bakelite case.

\$1045

Model 1220 comes complete with cover, self-contained battery, test leads and instructions. ONLY

SUPERIOR INSTRUMENTS CO.

136 LIBERTY ST. Dept. RC10
NEW YORK, N. Y.

audio frequencies, the reader can picture for himself what must be happening at R.F. levels.

Of course, portable audio-frequency amplifiers, portable radio receivers, cathode-ray equipment, etc., can also be used for checking ground connections, potential gradients, and static and signal content of power lines and ground circuits. This checking will indicate the most serious sources of trouble and to what extent filtering, grounding and ground linkage are necessary.

ADDENDUM

Referring to Fig. 1, grounding wires from radiators to sinks connect to all piping, old grounded wires, all "BX" and conduit, building girders, etc.; all are ganged into a ground network which in effect lifts the ground up to the receiver by greatly reduc-

ing the R.F. impedance to the earth below.

Referring to Fig. 2, the component values are as follows: 1st pair of condensers in the power line filter, 0.01-mf., tubular, 400 V. (each); 2nd pair, 0.1-mf., ditto; 3rd pair, 1 mf., ditto. The 1st pair of chokes are made by winding 10 turns of No. 14 enam. wire on a form 1 to 2 ins. in dia.; 2nd pair, 20 turns, ditto; 3rd pair, 30 turns, ditto.

As is generally known, "static" signals are highly complex transients containing a multitude of component frequencies. Therefore they cannot be trapped or "tuned out" by any simple network. The filter used is a 3-stage affair with a gradually increasing resonance period. There is nothing critical about this circuit; it is merely an attempt to decrease the amplitude of the complex transients that smear from one end of the radio spectrum to the other.

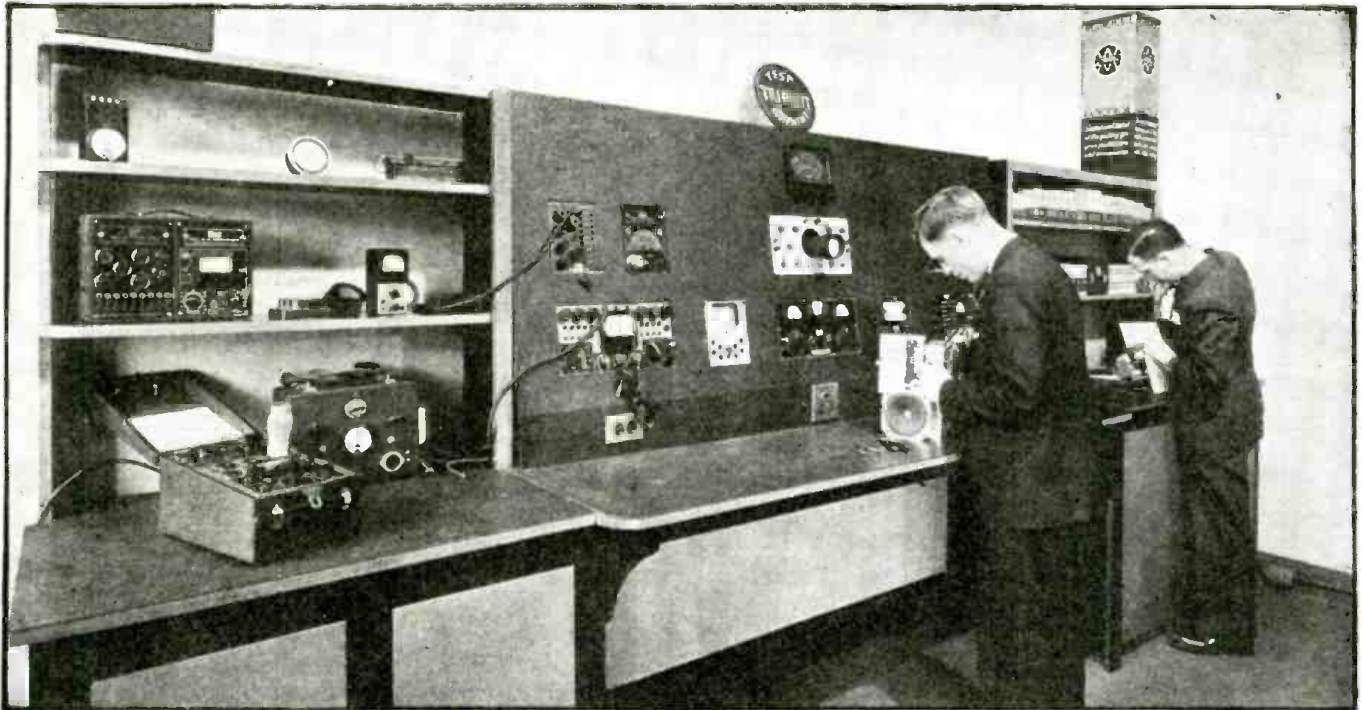

Fig. B. Interior view of the Model Service Shop of the Radio College of Canada, showing highly efficient arrangement of test bench and equipment.

MODEL RADIO SERVICE SHOP

A prominent Radio School points the way to new efficiency and profits in servicing by way of a modern radio servicing setup. It is hoped that this Model Service Shop will serve as a pattern for all aggressive Servicemen.

A NOTABLE advance in radio training technique was established a few months ago at Radio College of Canada (Toronto, Ontario). This new development consists of a period of training in a *model service shop* as part of the regular Applied Radio and Electronics Course conducted by the College.

When Radio College took over its new school building some time ago, a complete Model Service Shop was built into one of the laboratories. Advanced students in small groups are assigned to operate the shop. Receivers, upon which faults of various kinds have been placed, are taken into the shop, the students making the necessary analyses and repairs, and keeping all records, creating window displays, etc. These sets are of course taken from the large stock owned by the college; no work of any sort is done for outsiders.

This unique shop possesses many features that will, it is believed, be of considerable interest to radio men and for that reason it will be described in this article. The shop is complete in practically every detail. It has a standard store front of modern design with a center door arrangement and a plate-glass show window on either side. The interior is well arranged, particularly in view of the somewhat limited floor area available, and provides plenty of working space.

An exterior view is shown in Fig. A. The show windows are of plate-glass, each window measuring 4 ft. 11 ins. x 4 ft. 7 ins. plus the "wings." The door is of standard construction with hardware of modern styling. The exterior is finished in cream, except for the door which is in an attractive shade of green. The window mouldings are of aluminum. The awning is in a brick red.

THE SERVICE BENCH

The service bench (Fig. B) is in 3 sections. Receivers awaiting first tests may be examined in the first section at the left of the test panel. Sets undergoing preliminary or final tests are moved to the center bench convenient to the test panel in which all necessary equipment has been assembled. After a set has been checked and the trouble located, the repair work if at all involved can be done on the bench to the right, on which most of the mechanical work is done.

The set can then be transferred again to the center bench for the final test and adjustment.

Above the 2 end benches there are shelves for tubes, test equipment, parts, and so on. Below these benches, commodious cupboards with double doors and shelves hold the reserve stock of parts as well as additional

instruments, display materials, literature, etc.

All benches, including the tops, were constructed of pine but in order to provide a smooth, hard surface of good appearance the tops were covered with a black pressed-wood board. This board is quite hard and is permanently colored black all the way through. It is easy to clean, does not show scratches readily and is hard enough to stand a reasonable amount of abuse.

THE TEST PANEL

The test panel in the center is 7 ft. long x 3 ft. wide, and is solidly constructed of pine covered with a sheet of the same type and color of pressed-wood board as the bench tops. This panel slants slightly and is rigidly braced by means of wooden strips and end pieces. The construction is such



Fig. A. Exterior view of the Model Service Shop of the Radio College of Canada.

that the panel is an individual unit separate from the benches or shelves so that it can be pulled out on the bench if it is necessary to remove instruments or do any work at the back.

The panel assembly is held firmly in place by means of 2 slotted metal strips fastened to the tops of the adjacent shelves. These strips project over to the top of the panel and are fastened to it by means of wood-screws. To remove the panel it is necessary only to loosen the screws, after which the panel assembly can be slid out on the bench.

The instruments were placed behind the panel, fitting up against the openings. The larger pieces of equipment are supported by small shelves fastened to the back of the panel.

In most cases all equipment operated from 115-volt lines is plugged into outlet boxes mounted on the wall behind the panel.

On the lower part of the panel there is one 60-cycle and two 25-cycle outlets. These are connected to outlets on the wall behind the panel by means of BX cable with enough slack left to permit moving the test panel well out on the bench.

The power supplied in Toronto is 25-cycles and as 60-cycle A.C. is needed for some of the instruments as well as for testing 60-cycle equipment, a remote-controlled 60-cycle, 115-volt motor-generator was installed in another laboratory. This motor-generator has a switchboard with relay, voltmeter, relay transformer, switches, pilot lights, etc. The relay, which has a 6-volt coil, is controlled by switches installed alongside the various 60-cycle outlets in the school; one of these switches is located at the left of the 60-cycle outlet in the service shop. When a relay switch is closed the relay closes the motor circuit. A pilot light indicates that the unit is running ready for use.

The instruments are arranged to provide 2 complete test positions and include signal generators, volt-ohm-milliammeters, vacuum-tube voltmeters, tube testers, set analyzers, a high-voltage television tester, vibrator tester, oscilloscope, condenser bridge, resistance indicator, etc., as well as separate portable instruments and meters of various kinds.

The directors of the College state that the Model Shop is always open for inspection. They will be glad to welcome members of the trade at any time and to give them whatever information concerning the construction of the shop they may desire.

This article has been prepared from data supplied by courtesy of Radio Trade Builder.

BUY DIRECT FROM THE MANUFACTURER AND SAVE

THE NEW MODEL 1280 SET-TESTER

A complete testing laboratory all in one unit. Tests all tubes, reads A.C. volts, D.C. volts, A.C. current, D.C. current, High Resistance, Low Resistance, High Capacity, Low Capacity, Decibels, Inductance, and Watts.

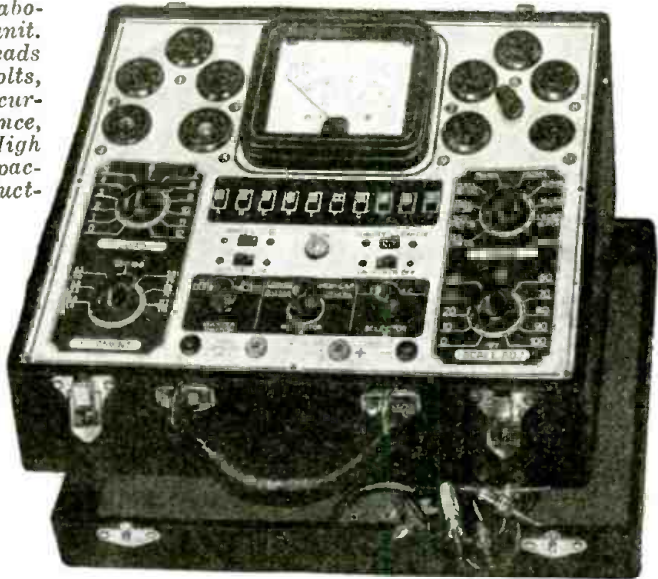

- ★ instantaneous snap switches reduce actual testing time to absolute minimum.
- ★ Spare socket, and filament voltages up to 117 volts make the Model 1280 proof against obsolescence.
- ★ Latest design 4½" D'Arsonval type meter.
- ★ Comes housed in attractive, leatherette covered carrying case.
- ★ Sloping panel for rapid, precise servicing.
- ★ Works on 90-125 volts 60 cycles A.C.

The primary function of an instrument is, of course, to make measurements accurately and when designing test equipment this is our first thought. However, we also appreciate the important part the appearance of an instrument plays in the impressions a serviceman makes on his customers, especially on home calls. We have, therefore, paid special attention to the outward design of all of our new instruments. For instance the panel of this Model 1280 is made of aluminum and etched by a radically new process, which results in a beautiful, confidence-inspiring appearance.

SPECIFICATIONS

- ★ Tests all tubes, 1.4 to 117 volts, including 4, 5, 6, 7, 7L, octals, loctals, Bantam Jr., Peanut, single-ended, floating filament, Mercury Vapor Rectifiers, the new S series, in fact every tube designed to date.
- ★ Spare socket included on front panel for any future tubes.
- ★ Tests by the well-established emission method for tube quality, directly read on the GOOD ? BAD scale of the meter.
- ★ Jewel protected neon.
- ★ Tests shorts and leakages up to 2 megohms in all tubes.
- ★ Tests leakages and shorts in all elements AGAINST all elements in all tubes.
- ★ Tests BOTH plates in rectifiers.
- ★ Tests individual sections such as diodes, triodes, pentodes, etc., in multi-purpose tubes.
- ★ Latest type voltage regulator.
- ★ Features an attractive etched aluminum panel.

Complete A.C. and D.C. Voltage and Current Ranges.
 D.C. Voltage: 0-15, 0-150, 0-750 Volts.
 A.C. Voltage: 0-15, 0-150, 0-750 Volts.
 D.C. Current: 0-1, 0-15, 0-150, 0-750 ma.
 A.C. Current: 0-15, 0-150, 0-750 ma.
 Resistance Ranges: 0-500 ohms, 500-5 megohms.

High and Low Capacity Scales: .0005 to 1 mfd. and .05 to 50 mfd.
 3 Decibel Ranges.
 -10 to +19.
 -10 to +38, -10 to +53.
 Inductance: 1 to 700 Henries.
 Watts: Based on 6 MW. at 0 D.B. in 500 ohms .006000 MW. to 600 watts.

Model 1280 comes complete with test leads, tabular charts, instructions, and tabular data for every known type of receiving tube and many transmitting tubes. Shipping weight 18 lbs.

ONLY \$19.95

PORTABLE COVER \$1.00 ADDITIONAL

SUPERIOR INSTRUMENTS CO., 136 LIBERTY ST., DEPT. RC 10
 NEW YORK, N. Y.

A Few of the Feature Articles in the October Issue of RADIO & TELEVISION

Building an 8 x 10 inch Image Universal Television Receiver.
 By Ricardo Muniz, E.E.

A Sensitive Capacity Relay. By Harry G. Cisin, M.E.

The New Browning Frequency Modulation Transceptor. By G. H. Browning
 Greater Power With the "R.&T." Economic Transmitter.
 By Herman Yellin, W2AJL

5, 10, and 20 Meter Cathode-Modulated Transmitter.
 By Harry D. Hooton, W8KPX

F.C.C. Quiz Questions for Radio Operator's License.

How to Build a Sensitive String Galvanometer. By Raymond B. Wailes

With all the Usual Departments, Including Question Box, Electrical Experiments, Television Department, Latest Radio Patents, Easy Set Building, Radio Kinks, Radio Hook-ups.

GOLDENTONE .50% OFF

DEAL DIRECT - - -
FACTORY PRICES -
 Over 60 models to choose from - 4 to 12 tubes. Portables \$8.98 up. Farm sets \$8.98 up. Car sets \$8.98 up. Foreign band sets \$8.98 up. Samples 50% off. Quantity discounts. Free 1941 Bargain catalog gives details of 10-day FREE TRIAL. Dealer's proposition and discounts. Mail postcard GOLDENTONE RADIO CO., DEPT. RC, DEARBORN, MICH.

NO BUY TRIAL **4.95** **READY TO PLAY** **YEAR GUARANTEE**

Free Catalog On RCA

Solar Condenser QUICK-CHECK

Spts "bad ones" while set is operating
 Quick as a Wink
 Write for Bulletin QC
SOLAR MFG. CORP. Bayonne, N. J.

in the full treble position (slider at bottom) C3 becomes shorted and this prevents any bass compensation giving a full treble range at any volume setting.

(4) POWER SUPPLY INCLUDES INTENSIFIER VOLTAGE

DU MONT MODEL 180.—For use with the recently-developed television image receiving cathode-ray tube using an intensifier element, the power supply includes a high-voltage source for this purpose. To avoid extreme voltages—either positive or negative—with respect to ground in this television receiver the ground is established at about the center of the total high voltage.

As the diagram in Fig. 4 shows, the cathode of the cathode-ray tube is several thousand volts negative with respect to ground while the intensifier is several thousand volts positive. A separate rectifier with an extremely small load (40 megohms) is used for the intensifier supply. It has a potential of 7,000 or 8,000 volts with respect to the cathode but only about half of this to ground.

The intensifier allows for lower 2nd-anode voltages; or a more intense image for the same anode voltage.

(5) SIMPLIFIED IMPULSE SEPARATOR CIRCUIT FOR TELEVISION

GENERAL ELECTRIC MODELS HM225 AND HM226.—By means of a double triode, 6F8G, using resistance-capacity filtering at both input and output with a "cathode-follower" circuit, horizontal and vertical synchronizing impulses are effectively separated.

As shown in Fig. 5, the entire video signal enters one grid through C57. While the vertical impulse is present at the 1st cathode it is attenuated due to the low cathode resistance and substantially eliminated by the 150 mmf. condenser C58 which couples the horizontal (high-frequency) impulse to the deflection amplifier. Condenser C67 in shunt with the grid input to the other 6F8G triode section with the large grid resistance value serves to bypass most of the horizontal deflection signal while the vertical (low-frequency) signal is amplified and coupled through C60 (0.002-mf.) to the vertical deflection amplifier.

USEFUL ANIMALS



Elaine Bassett vies for attention in competition with utilitarian animals. "If animals could only talk . . . last month became a wish fulfilled when this G.O.P. elephant and Democratic donkey passed on to associated amplifiers the national conventions proceedings picked-up by the special, non-directional microphones they concealed.

BUY DIRECT FROM THE MANUFACTURER AND SAVE



THE NEW MODEL 1230 SIGNAL GENERATOR WITH FIVE STEPS OF SINE-WAVE AUDIO

SPECIFICATIONS

RADIO FREQUENCIES from 100 KC. to 90 Megacycles in 7 bands by front panel switch manipulation. All direct reading and accurate to within 1% on I.F. and Broadcast bands, 2% on higher frequencies. The R.F. is obtainable separately or modulated by any one of the five Audio Frequencies.
AUDIO FREQUENCIES: 5 steps of SINE-WAVE audio 200, 100, 1000, 5000 and 7500 cycles WITH OUTPUT OF OVER 1 VOLT. Any one of the above frequencies obtainable separately for servicing P.A., hard-of-hearing aids, etc.
ATTENUATOR: Late design, full-range attenuator used for controlling either the pure R.F. or modulated R.F.

CIRCUIT: The Model 1230 employs an improved electron coupled oscillator circuit for the R.F. affording positive protection against frequency drift and a Hartley oscillator circuit for the A.F. section.
DIAL MANIPULATION: Large 5 1/2" dial etched directly on front panel, using a new mechanically perfected drive for perfect vernier control.
APPEARANCE: The front panel is etched by a recently perfected process which results in a life-long attractive finish and the instrument comes housed in a streamlined shielded cabinet.
CURRENT SOURCE: The Model 1230 operates on 90 to 130 volts A.C. or D.C. any frequency.

The Model 1230 comes complete with tubes, shielded cables, moulded carrying handle and instructions. Size 11" x 6" x 11". Shipping weight 15 pounds. ONLY **\$1285**

THE NEW CHANNEL ANALYZER

Follows the SIGNAL from Antenna to Speaker of Any Set

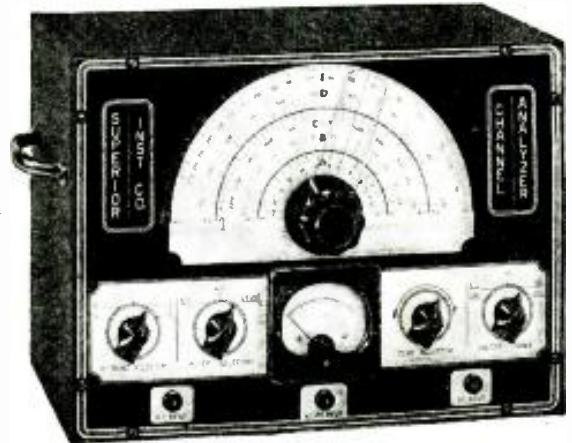

The well-established and authentic SIGNAL TRACING METHOD of locating the very circuit in which there is trouble, and the very component that causes the trouble, is now for the first time available at a price any radio serviceman can afford.

THE CHANNEL ANALYZER WILL

- * Follow signal from antenna to speaker through all stages of any receiver ever made.
 - * Instantly track down exact cause of intermittent operation.
 - * Measure both Automatic-Volume-Control and Automatic-Frequency-Control voltages and circuits without undeniably loading the circuit, using built-in highly sensitive Vacuum-Tube Voltmeter.
 - * Check exact gain of every individual stage in receiver.
 - * Track down and locate cause of distortion in R.F., I.F., and A.F. amplifier.
 - * Check exact operating voltage of each tube.
 - * Locate leaky condensers and all high-resistance shorts, also show opens.
 - * Measure exact frequencies, amount of drift and comparative output of oscillators in superhets.
 - * Track down exact cause of noise.
- The Superior Channel Analyzer comes housed in shielded cabinet and features an attractive etched aluminum panel. Supplied complete with tubes, three specially engineered shielded input cables, each identified as to its purpose. Also full operating instructions. Size 13" x 10" x 6". Shipping weight 19 pounds. Only **\$1975**

SUPERIOR INSTRUMENTS CO. 136 LIBERTY ST. Dept. RC10
NEW YORK, N. Y.

CATALOGS CONTAINING TECHNICAL INFORMATION

Several catalogs brought to the attention of Radio-Craft last month contain technical material of especial interest to engineers, Servicemen, etc., as follows: Thordarson (Chicago) catalog No. 500-E, describes the elements of filters and line equalizers. . . . Standard Transformer Corp. (Chicago) 6th Edition Service Guide and Replacement Transformer catalog lists all the foremost radio sets and their transformer requirements. Included are circuit and construction details for an audio signal generator, photocell control unit, and 2 fence controllers (one 6 V. D.C. and 110 V. A.C.) . . . Ideal Commutator Dresser Co. (Sycamore, Ill.) has a *New Catalog and Handbook* (Cat. No. J-239) that contains valuable information

on installation and servicing of motors and generators. Electrical terms are defined. Tables, formulas, and N.E.L.A.-recommended electrical shock resuscitation procedure conclude the publication. . . . John Meck Industries (Chicago) last month issued Bulletin No. 10 containing practical data on the design and matching of speaker systems for efficient sound distribution, and for obtaining uniform coverage. . . . In their new catalog-book, Allen B. Du Mont Labs. (Passaic, N. J.), presents considerable information of interest to students of electronics, in the section on oscilloscope specifications, under such headings as Cathode-Ray Tube, Brilliance, Deflection, Fluorescent Screens, Low- and High-Frequency Compensation, Transients, etc.

Radio Service Data Sheet

GENERAL ELECTRIC MODELS H-639 A.C. AND H-639 D.C. RADIO-PHONOGRAPH COMBINATIONS

6-Tube Superhet.; Broadcast Band (550 to 1,600 kc.); Built-In Inverter (Model H-639 D.C. only, to permit operation of phono motor on D.C.); Power Output (max.), 2.5 W.; Crystal Pickup.

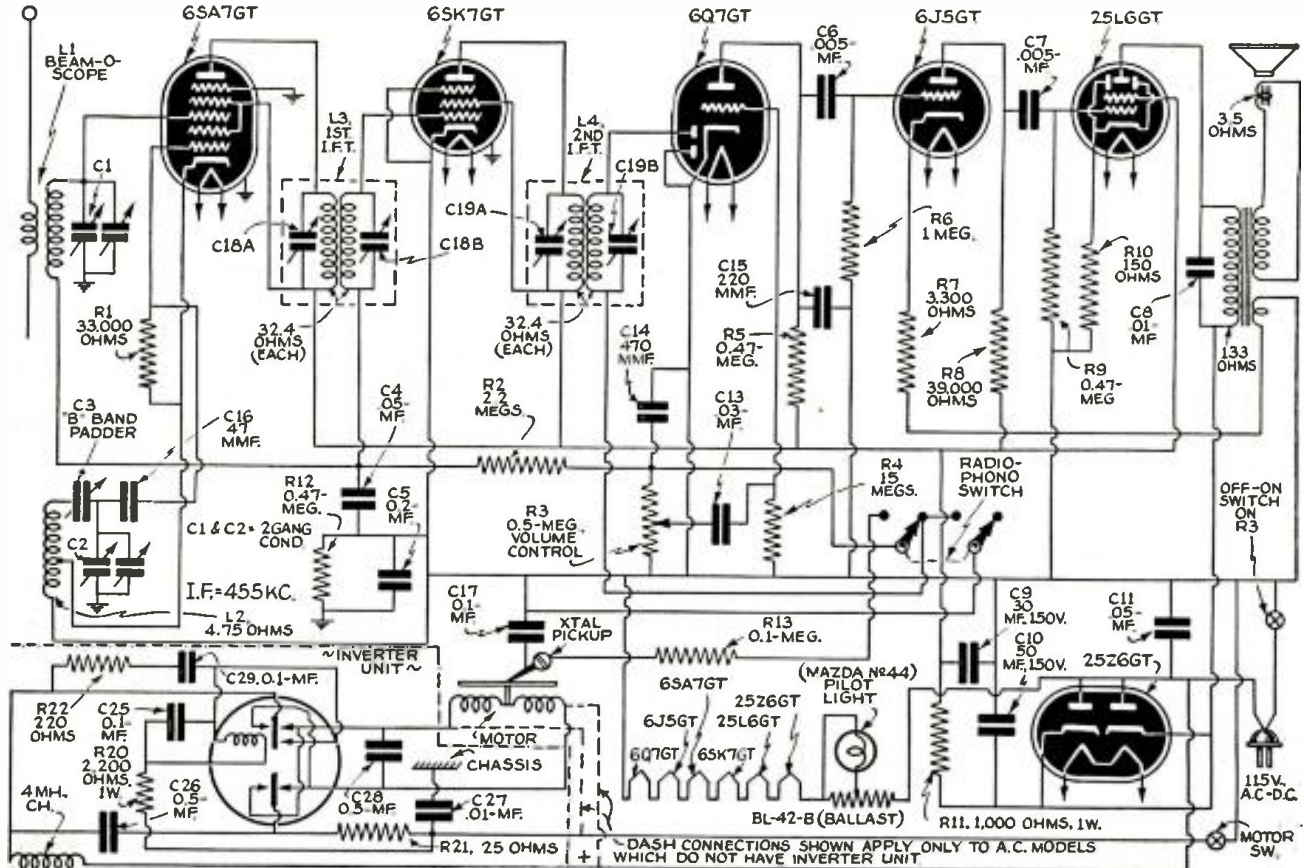

Schematic diagram of models H-639 A.C. and H-639 D.C. Inverter unit not included in A.C. model.

ALIGNMENT PROCEDURE

Alignment Frequencies

I.F. 455 kc. R.F. 1,500 and 580 kc.

The location of all trimmers is shown in the diagram at right.

I.F. Alignment

Connect an output meter across the voice coil. Turn the volume control to maximum. Set test oscillator to 455 kc. and keep the oscillator output as low as a readable meter reading will permit. Apply signal to the grid of the 6SK7GT through a 0.05-mf. condenser and align the 2nd I.F. transformer. Repeat the procedure, applying the 455 kc. signal to the control-grid of the 6SA7GT and aligning the 1st I.F. transformer. Finish by over-all adjustments.

R.F. Alignment

With gang condenser plates completely closed, set dial pointer to the first mark at the left end of the scale. Apply a 1,500 kc. signal either through a standard I.R.E. dummy to the antenna terminal or through an additional loop connected to the generator output which can be magnetically coupled to the receiver Beam-a-Scope. Align C2 at 1,500 kc. and peak C1 for maximum output. Peak C3 on 580 kc. while rocking the gang condenser. Retrim at 1,500 kc.



General Electric models H-639 A.C. and H-639 D.C. table-type combination radio-phonograph.

Special Service Information

The following data will be very useful to Servicemen equipped with vacuum-tube voltmeters or similar voltage measuring instruments.

- (1) Stage Gains
Antenna Post to Converter Grid—4 at 1,000 kc. †
Converter Grid to 6SK7GT Grid—30 at 455 kc. †
6SK7GT Grid to 6Q7GT Det. Plate—100 at 455 kc. †
- (2) Audio Gains
0.06-volt, 400-cycle signal across volume control set to maximum will give approx. ½-watt

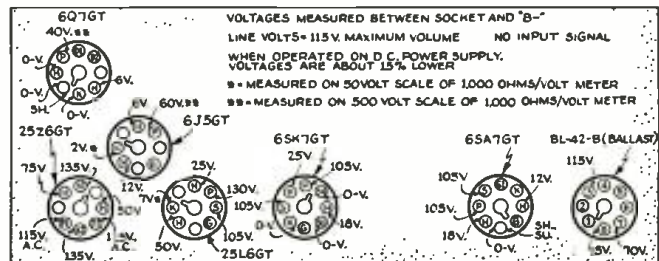
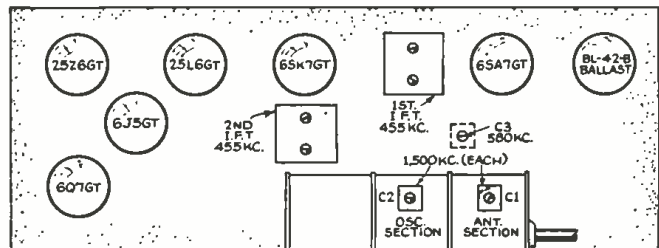

Top, location of trimmers and main components; above, complete operating voltages.

speaker output.
(3) D.C. voltage developed across oscillator grid resistor R1 averages 12 volts.
† Variations of +10%, -20% permissible.

Production Changes
Early production receivers had a 0.002-mf., 600-V. paper condenser in series with the high side of (L1) primary, and the lower side was connected to the chassis.
The 6SA7GT, 6SK7GT, 6Q7GT and 6J5GT can be replaced with metal tubes if the receiver is realigned.

OPERATING NOTES

Trouble in . . .

. . . AIRLINE MODEL 62-351

After a period of usage the pushbuttons (mechanically by levers) of this set cease to operate. These levers actuate on discs slipped on the shaft of the variable condenser and secured by the pressure exerted by a spring washer at one end. For a thorough job slip an ordinary washer next to the spring washer thick enough to increase pressure against the discs, and after adjusting each disc to correspond correctly, solder the discs directly to the brass spacers located between discs. This will bring greater friction into play, thereby lessening "slips."

JORGE ESCOBAR,
Escobar Radio Service,
Magnolia 30-10,
Mexico City, Mexico.

. . . SILVERTONE (SEARS, ROEBUCK)

BATTERY SETS

This note is in regard to Silvertone Battery-Operated Receivers using a type 1C6 tube as the R.F. amplifier and mixer. The complaint in nearly all cases was that the set operated perfectly on either shortwave bands or on the higher-frequency standard broadcast band, but on approaching approximately 800 kc. the set became inoperative and the oscillator even stopped functioning. The tubes in these sets would invariably test OK.

After several attempts at alignment and finding that the sets were in alignment with a signal generator I found that the 1C6 tube though testing OK was giving trouble. In some cases it required nothing more than replacing the 1C6 and some cases showed that the ballast tube had changed value causing a slight discrepancy in the filament voltage. In either case the trouble cleared up and another headache was out of the shop.

LARRY M. STEWART,
Radio Service Dept.,
Gwin Tire & Supply Co.,
McComb, Miss.

. . . G.E. E155 15-TUBE RADIO SET

When this radio receiver operates with fair volume on local stations, and weak on distance, check the 0.05-mf. bypass condenser in the grid circuit of the 1st I.F. coil. This condenser is quite difficult to find as it does not affect the plate voltage and unless a signal generator is used it would hardly be suspected. This condenser is marked T C 40 on the G.E. diagram.

THOS. R. DISSINGER,
5036 Wrightwood Ave.,
Chicago, Ill.

. . . MAJESTIC MODEL 90

If a complaint of "inoperating" is received in connection with this set, check on the 1.6-ohm wire-wound center-tapped resistor connected across the filaments. If this resistor gets so hot that it burns out, check all plate bypass condensers, because if any of these short it will cause a very large current to flow through the filament center-tap thereby causing it to burn out and the set will go dead.

. . . G.E. MODEL H-639 A.C.

This set has a Phono-Radio switch, connected mechanically to the pickup arm, that frequently is a source of noisy operation, and the cause of occasional inoperation. When the pickup is raised upward, the phonograph switches-in and when it's

"YOUR EQUIPMENT HAS UNFAILINGLY MEASURED UP TO OUR HIGH STANDARDS"

... writes
C. H. MANSFIELD
President

HOLLYWOOD RADIO & TELEVISION INSTITUTE



No ordinary test instrument buyer is C. H. Mansfield. He heads a technical Radio Institute which orders test instruments in large quantities for students in nearly every country of the world. "It is extremely important," Mr. Mansfield says, "that the testing equipment we give to our students measure up to the very highest standards; we cannot afford to compromise with quality. . . . The (RCP) testing instruments which we have purchased from you have given 100% satisfaction."

Take advantage of RCP Proven Dependability! Here are typical RCP Quality Instruments, tailored to the requirements of all service jobs.

MODEL 310 TUBE TESTER

Tests every type of tube. Spare socket for future tubes with new base arrangements. Famous dynotimum test circuit gives finest correlative test made under plate voltages and loads as specified by R. M. A. Separate test for noise, hum, intermittents, bad connections. Hot interelement short and leakage test between all individual elements; hot cathode leakage tests. Accurate calibration checked against laboratory standards. Newest "Rolindex" roller type tube test chart insures smoothest, positive, speedy operation. De luxe line cord and plug—double fused line protection.

\$21.95

MODEL 310 C for counter use has sloping front, size 11 1/2 x 13 1/2 x 7
MODEL 310 P for combination portable-counter use. Slip-hinge cover, Bakelite handle. Compartment for tools \$23.95



COMBINATION TUBE AND SET TESTER
MODEL 803

with the new Automatic Rolindex Tube Test Charts

This portable "service shop" tests all latest tubes, miniature and bantam. J.r., all filament voltages (at standard R. M. A.). Exclusive measurement method eliminates large errors. Hot interelement short and leakage tests for individual elements. Individual section tests of multi-purpose tubes. Line voltage regulation 103 to 135 volts meter indication. Noise test for tubes which otherwise test good. Roller type tube chart built in.
DC voltmeter 0/10/50/500/1000 at 1000 ohms per volt
Four range AC voltmeter 0/10/50/500/1000
DC milliammeter 0/1/10/100/1000 DC Ammeter 0/10
Ohmmeter 0/500/5000/1,000,000/10,000,000
D.B. Meter -8 15/15 to 29/29 to 49/32 to 55 decibels
Four range Output Meter same as AC volts

\$32.95

Complete, ready to use with test leads. Model 803 RCP Combination. Model



PORTABLE AC-DC MULTITESTER
MODEL 446 P

Portable lead and test leads ● Five range DC voltmeter 0/5/50/250/500/2500
● Four range DC milliammeter 0/1/10/100/1000 ● DC Ammeter 0/10 ● Four range AC voltmeter 0/10/100/500/1000 ● Three range ohmmeter 0/500/100,000/1 Meg. ● Four decibel ranges -8 to 15/12 to 35/26 to 49/32 to 55

\$11.50

It's the equivalent of 25 different instruments in a single case. Has compartment for test prods and small tools. Complete with test prods and batteries. Appearance, quality and performance put it in a class with testers selling for twice the price. In handsome hardwood case with hinged cover.

\$11.50

\$11.50

PAY LESS for your test instruments and show a bigger profit. Send postcard today for free catalog describing complete RCP dependable line.

RADIO CITY
PRODUCTS CO. INC.
88 PARK PLACE, N. Y. C.

pushed back down the receiver switches-in. Always check this switch when receiver is inoperative or noisy, because the contacts become dirty or loose.

. . . PHILCO MODEL 54

If this set motorboats intermittently replace the 0.01-mf. coupling condenser that connects from the volume control to control-grid of the 75 tube. This is condenser No. 28 in the factory circuit diagram.

. . . PHILCO MODEL 620

If this set cuts off and refuses to play any more replace the plate bypass condenser of the type 75 2nd detector. This is the bakelite-enclosed condenser indicated on the factory diagram as part No. 57.

HAROLD R. KUNTZ,
Brooklyn, N. Y.

. . . AUTOMATIC COIN PHONO-HOPPER FAILS TO SELECT

Failure of hopper to select may be caused by any of the following quite troublesome faults: warped records, improper loading of hopper, selector rod improperly adjusted and mechanism associated with same causing erratic operation. Also, failure to oil and properly clean off excessive oil which in turn may cause verdigris and also cause selector arm to become sluggish and affect the mechanism associated with the hopper. Check the hopper weight, also the arm, for any break or bent hopper arm which may unbalance the hopper and also fail to place the records in the proper position. This trouble was experienced quite a few times on different makes of automatic slot machines.

GEO. F. BAPTISTE,
Howard, R. I.

Radio Service Data Sheet

GENERAL ELECTRIC MODEL J-71

7-Tube Superhet.; 110-V. A.C. Operation; 3 Bands (Broadcast, 540 to 1,600 kc.; Shortwave No. 1—2,300-6,900 kc.; Shortwave No. 2—6,900-22,000 kc.); Output (max.), 4.5 W.; Built-In Dual "Beamscope" Antenna; Pushbutton Tuning; Iron-Core Coils; Single-Ended Tubes; A.V.C.

(See Data Sheet 291 for additional information.)

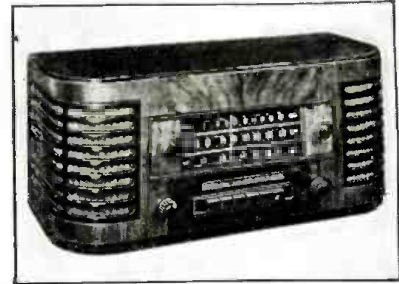
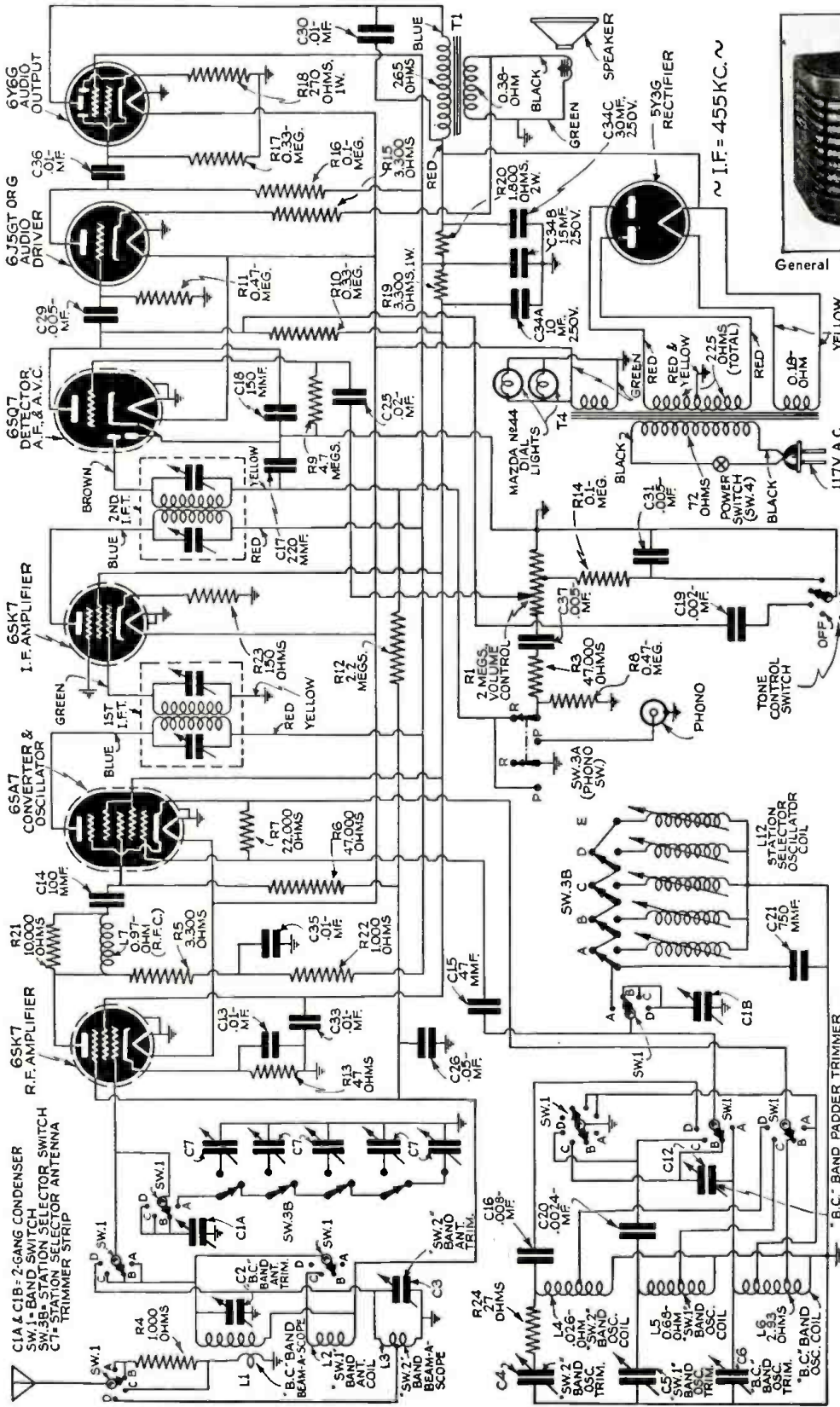

General Electric model J-71 3-band receiver.

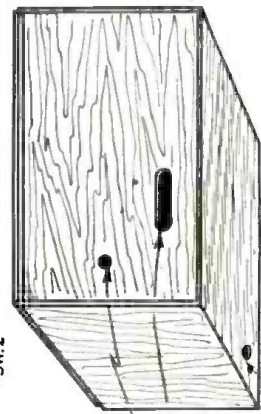

OPENING IN CABINET BOTTOM FOR ADJUSTMENT OF C12



OPENING IN CABINET BACK FOR ADJUSTMENT OF C3, C4, C5, C6

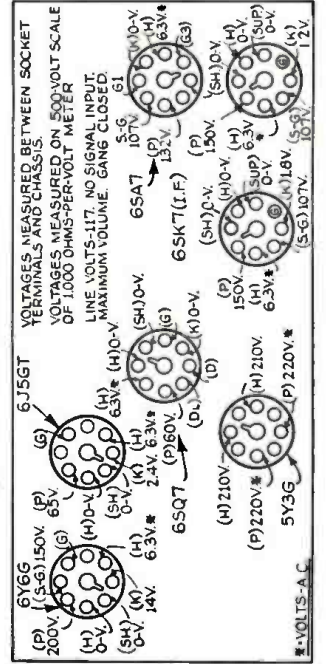

GENERAL ELECTRIC MODEL J-71

7-Tube Superhet.; 110-V. A.C. Operation; 3 Bands (Broadcast, 540 to 1,600 kc.; Shortwave No. 1—2,300-6,900 kc.; Shortwave No. 2—6,900-22,000 kc.); Output (max.), 4.5 W.; Built-In Dual "Beam-a-Scope" Antenna; Pushbutton Tuning; Iron-Core Coils; Single-Ended Tubes; A.V.C.

(See Data Sheet 290 for additional information.)

CHASSIS OR BEAM-A-SCOPE REMOVAL

Note: Care must be exercised in removing the chassis to avoid changing the shape of either the shortwave or broadcast loops. These loops are factory formed to give a certain inductance and any alterations in the loops in the field will throw the chassis out of alignment.

When disconnecting the shortwave loop leads from the loop, be sure to support the loop while pulling off the connections. Failure to support the loop may cause the staples to loosen and result in the loop rattling in the cabinet.

SPECIAL SERVICE INFORMATION

The following information will be very useful in servicing receivers if a vacuum tube voltmeter or similar voltage measuring instrument is available.

- (1) Stage Gains*
 - (a) Antenna Post to R.F. Grid at
 - 1,000 KC.....5.5
 - 4,000 KC.....2.5
 - 18,000 KC.....2.5
 - (b) R.F. Grid to Converter Grid at
 - 1,000 KC.....5.5
 - 4,000 KC.....3.0
 - 18,000 KC.....2.0
 - (c) R.F. on Converter Grid to I.F. on 1st I.F. Grid at
 - 1,000 KC.....5.0
 - 4,000 KC.....5.0
 - 18,000 KC.....4.5
 - (d) I.F. on Converter Grid to I.F. on 1st I.F. Grid at
 - 455 KC......60
 - (e) I.F. Amplifier Grid to Detector Plate at
 - 455 KC......55
- (2) Voltage across Volume Control to Give 1/2-watt Speaker Output at
 - 400 cycles......04 volts
- (3) D.C. Voltage Developed across Oscillator Grid Resistor (1L-7) at
 - 1,000 KC.....8.3
 - 4,000 KC.....7.8
 - 18,000 KC.....4.6

*Variations of ± 20% permissible. All readings obtained with enough input signal to give 1/2-watt speaker output.

ALIGNMENT PROCEDURE

The alignment procedure is given in table form below. The use of a standard I.R.E. dummy antenna in making all R.F. alignments is recommended. R.F. alignment can be performed by loop coupling the generator signal to the receiver Beam-a-Scopes if care is exercised not to overcouple the two circuits. Keeping a distance of 2 ft. or more between the generator loop and the receiver Beam-a-Scope will generally insure freedom from overcoupling. The relative position of the Beam-a-Scopes with respect to the chassis materially affects R.F. alignment; therefore, all R.F. alignments should be made with the chassis and Beam-a-Scopes mounted in the cabinet. In keeping with this recommendation all R.F. alignment trimmers are available through holes in the bottom deck and back of the cabinet as shown in figure 3. Metal objects such as meters, tools, etc., should not be placed on top of the receiver cabinet. Also the receiver should be kept away from large metal objects such as radiators, metal-top tables, etc.

I.F. Alignment with Oscilloscope

Band Switch Setting	Input Freq.	Point of Input	Dummy Antenna	Trimmer
1. "BC" Band See Note 1	455 kc. Sweep	I.F. Grid	0.05 mf. or larger	2nd I.F. Trimmers (10, 11)
2. "BC" Band	455 kc. Sweep	Green lead on "BC" Beam-a-Scope terminal board and chassis ground.	0.05-mf. or larger	1st I.F. Trimmers (8, 9)

I.F. Alignment with Output Meter

1. "BC" Band See Note 2	455 kc. with Modulation	Green lead on "BC" Beam-a-Scope terminal board and chassis ground.	0.05-mf. or larger	2nd I.F. Trimmers C10, 11, 1st I.F. Trimmers (8, 9)
----------------------------	-------------------------	--------------------------------------------------------------------	--------------------	-----------------------------------------------------

R.F. Alignment with Chassis Mounted in Cabinet

1. "BC" Band See Note 3	1,500 kc. with Modulation	Antenna Post	I.R.E.	Osc. (C6) Ant. (C2)
2. "BC" Band See Note 4	580 kc. with Modulation	Antenna Post	I.R.E.	Osc. Padder (C12)
3. "BC" Band See Note 5	580 kc. with Modulation	Antenna Post	I.R.E.	Osc. (C6) Ant. (C2)
4. "BC" Band See Note 6	1,500 kc. with Modulation	Antenna Post	I.R.E.	Osc. (C6) Ant. (C2)
5. Repeat operation 3 if "BC" band trimmers are badly out of alignment.				
6. "SW 1" Band See Note 7	6 mc. with Modulation	Antenna Post	I.R.E.	Osc. (C6)
7. "SW 2" Band See Note 8	21 mc. with Modulation	Antenna Post	I.R.E.	Osc. (C4) Ant. (C3)
8. "SW 2" Band See Note 9	8 mc. with Modulation	Antenna Post	I.R.E.	
9. Repeat operation 7 if the Beam-a-Scope leads are moved in operation 8.				

COMMENTS

Note 1: Gang condenser plates closed. Depress any station key other than Phono-FM-Tel key. Connect audio input of oscilloscope to chassis ground and junction of R3 and R8. Adjust trimmers in order mentioned for a single symmetrical curve of maximum amplitude. Finish by retrimming 2nd I.F. trimmers.

Note 2: Gang condenser plates closed. Depress any key other than Phono-FM-Tel key. Connect output meter across voice coil. Keep input signal low and volume control on as far as possible. Adjust all trimmers for maximum output.

Note 3: Close gang plates, adjust pointer to first line at left end of tuning scale. Connect output meter across voice coil. Tone control set to "Normal" position.

Note 4: Set pointer to 1,500 kc. and tune in signal with (C6). Peak output with (C2).

Note 5: Set pointer to 580 kc. and peak signal while rocking gang condenser.

Note 6: Retrim for maximum output.

Note 7: Set pointer to 6 mc. and peak signal while rocking gang condenser.

Note 8: Set pointer to 21 mc. and tune in signal with (C4). Peak output with (C3) while rocking gang condenser. When (C4) is on proper peak, image of 21 mc. signal should be heard 910 kc. below or on 20.09 mc.

Note 9: This operation may or may not be necessary depending on how much the shortwave Beam-a-Scope leads have been moved from their correctly dressed positions. Repositioning will be indicated if an increased output meter reading can be obtained by moving the short-wave Beam-a-Scope phosphor-bronze lead closer or farther away from the black lead. The moving should be done with an insulated rod or stick.

R.F. ALIGNMENT WITH CHASSIS OUTSIDE OF CABINET

R.F. alignment can be performed only on the "BC" and "SW1" bands with the chassis outside of the cabinet. Any alignment attempt-

ed on "SW2" band will not be satisfactory. The same relative position between the chassis and broadcast loop should be maintained when aligning outside the cabinet as these components occupy in the cabinet. Since the glass dial scale is fastened to the cabinet it cannot be used for reference during alignment of the chassis outside of the cabinet. Use must be made, therefore, of a 0-180° calibrated scale which is cemented to the back of the dial reflector plate. From the reference shown on this Data Sheet the degree readings for corresponding frequency settings may be obtained by laying a straight edge across the chart perpendicular to the line of figures and sliding the straight edge along to the various frequency settings desired. The degree readings will be found on either of the degree scales. To use these degree readings, first completely close the gang condenser plates and then slide the pointer along the cord until the left-hand edge of the pointer-guide slide lines up with the 0° mark. By using this left-hand edge (as viewed from the rear) of the slide as the degree-scale pointer the receiver may be tuned to any frequency. Example: By rotating the tuning control until the left-hand edge of the slide is in line with 158°, the receiver will be tuned to 1,500 kc. on the "BC" band.

The "BC" and "SW1" band alignment procedure is the same as outlined in steps 2 to 6 inclusive of the chart "R.F. Alignment with Chassis Mounted in Cabinet."

After the alignment has been performed on the "BC" and "SW1" bands the chassis should be mounted in the cabinet and "SW2" band alignment checked as described in steps 7 to 9 of the chart "R.F. Alignment with Chassis Mounted in Cabinet."

Note: After moving the pointer along the cord to use the left-hand edge as a reference pointer for the degree scale, it will be necessary after reassembly in the cabinet for the gang condenser plates to be closed and the pointer to be moved back along the cord so that it lines up with the first dial markings on the left.

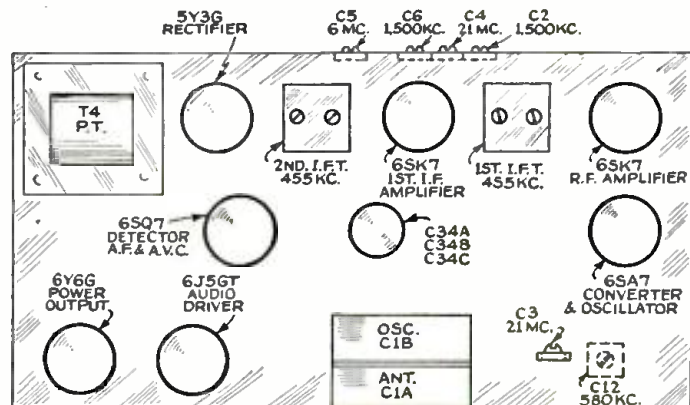
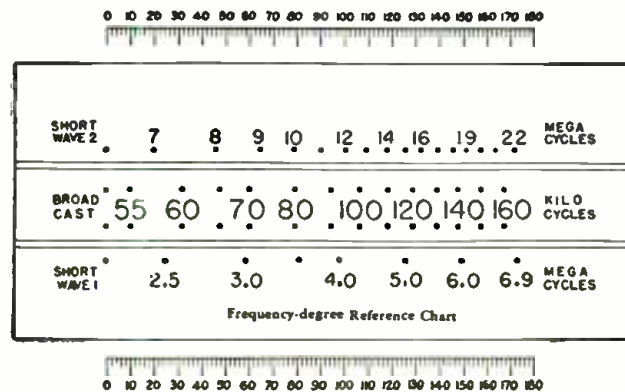

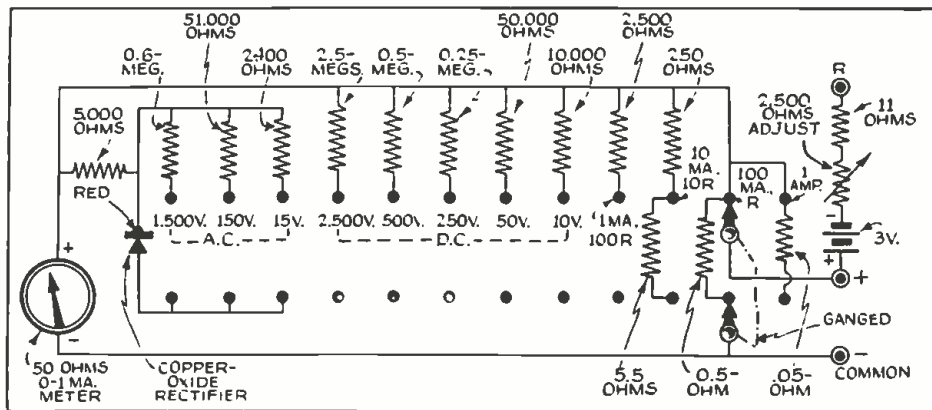

The features and design characteristics, and complete construction details, of an unusually useful and inexpensive multi-range meter are given in this article.

← The circuit (left) shows the unique use of a half-wave copper-oxide rectifier.

Build This 21-Range UNIVERSAL TEST METER

NO one will deny that in the past few years broadcast receivers have become extremely complicated in design and circuit arrangement. Yet paradoxically, the test instruments required by efficient Servicemen to repair these modern receivers have become relatively simple.

What with the modern method of dynamic servicing, a simple signal tracer and a volt-ohm-milliammeter are all that are required. Since several articles on signal tracers have recently appeared in *Radio-Craft* this article will concern itself with data on the construction of an inexpensive 21-range universal test meter (A.C.-D.C. volt-ohm-milliammeter, if you please).

FEATURES

The circuit of this instrument is so simple and the component parts so few that anyone able to handle a soldering iron and a pair of pliers can build it in a single evening. All the necessary parts are readily obtainable from local supply houses. The instrument reads A.C. and D.C. voltages, values of direct current, power output, db. levels, and values of resistance—all this by using a basic 0-1 ma. meter with a sensitivity of 1,000 ohms/volt. The use of a compact copper-oxide rectifier permits the readings of A.C. values.

Many A.C.-D.C. volt-ohm-milliammeter instruments in the past have had the disadvantage of loss of sensitivity, due to using the same series resistors for both A.C. and D.C. measurements, when using a 0-1 ma. meter as the basic instrument. Let's put it another way: when the same resistors are used for both A.C. and D.C. measurements, inaccurate readings result on either the A.C. or D.C. tests, inasmuch as the required resistance values may vary considerably unless a meter shunt is used. However, adding a shunt to the meter reduces its sensitivity.

This disadvantage is overcome in the present instrument by using separate resistors for all ranges. The higher sensitivity thus obtained results in smaller current drain on the measured circuit, thereby providing a truer reading. On A.C. ranges the sensitivity is somewhat less. However high sensitivity is not required here inasmuch as measurements are generally made across low-impedance circuits; transformer windings, filament, and line voltages are the principal ones generally read in radio

Front view of the completed Universal Test Meter. This "handful" of test instrument affords 21 meter ranges.

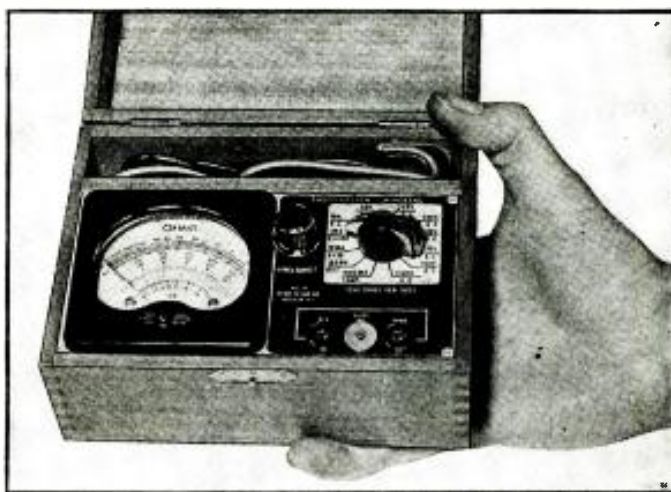

servicing. The use of the A.C. circuit shown in the schematic diagram permits the A.C. scale to be almost linear, which results in convenience and greater accuracy in reading.

The accuracy of the completed instrument will depend directly upon the tolerance of the resistors. Thus if it is possible to obtain resistors such as manufacturers use, which may be $\pm 1\%$, the resulting instrument will have greater accuracy than if the more conveniently-available 5%-tolerance resistors given in the List of Parts are used. Note also that the required value of the

limiting resistor and the values of the series resistors used on the A.C. voltage ranges will vary considerably depending upon the resistance of the individual copper-oxide rectifier used.

Unlike most meters, the A.C. Voltage section of this test instrument incorporates a half-wave rectifier instead of the full-wave type ordinarily specified in test meters. It may seem to the casual reader that the needle would oscillate under this condition; or that the calibration error would be large with wide ranges of frequency. However,

Inside view of the instrument here described. The double-deck gang switch operates as a 2-pole, 12-position switch.

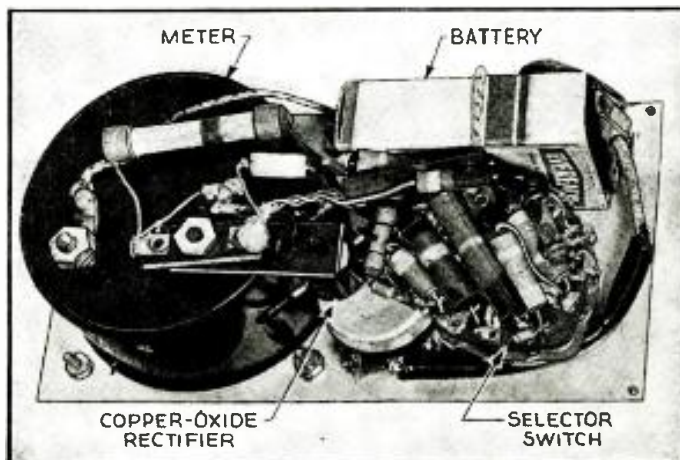

proper adjustment of the value of the limiting resistor corrects any needle-shimmy; and inasmuch as this meter is intended to be used only on the commercial line frequencies encountered in ordinary service work, the design here given is satisfactory.

The 0-1 ma. meter used in the instrument here described has an internal resistance of 50 ohms; and all shunt resistors have been calculated for this value. If the constructor wishes to use another meter, the internal resistance of which is other than this value, then the following formula should be used to compute the values of all shunts.

$$R = \frac{R_m I_m}{I - I_m}$$

where R = resistance of the shunt resistor (in ohms)

R_m = resistance of the meter (in ohms)

I_m = full-scale current reading of the meter (in amperes)

I = full-scale current reading for the new calibration (in amperes).

MEASUREMENTS

The ranges of this versatile instrument are: D.C. volts—0-10, 50, 250, 500, 2,500; A.C. volts—0-15, 150, 1,500; current—0-1, 10, 100, 1,000 ma. (1 amp.); db.—18, 38, 58; output meter—0-15, 150, 1,500; resistance—0-5,000, 50,000, 500,000 ohms.

By using a dual 12-position switch in a simple but effective circuit, it is possible to obtain all voltage, current and db. ranges from 2 tip-jacks. A third tip-jack is used for resistance measurements.

Output measurements are made by using the A.C. scale in any of the ranges, by inserting a 0.5-mf. 400-V. condenser in series with one of the test leads.

Before using any of the Resistance ranges it is necessary to adjust the meter for zero reading. This is done by shorting the 2 test leads and then setting the ohms adjust potentiometer (rheostat) for a full-scale meter reading. This procedure must be followed for each resistance range. It is interesting to note that the same shunt resistors which are used for the 3 resistance ranges are also in service when current alone is measured.

As shown in the illustrations a simple panel is used for mounting all components including the meter. The panel is made of etched aluminum 1/8-in. thick, measuring 3 x 5 1/4 ins.

The meter is fitted into a hole on one side and all remaining parts on the other side, resulting in a neat, compact appearance.

LIST OF PARTS

RESISTORS

- One I.R.C., 2.5-megs., 1/2-W., 5% accuracy;
- One I.R.C., 0.5-meg., 1/2-W., 5% accuracy;
- One I.R.C., 0.25-meg., 1/2-W., 5% accuracy;
- One I.R.C., 50,000 ohms, 1/2-W., 5% accuracy;
- One I.R.C., 10,000 ohms, 1/2-W., 5% accuracy;
- One I.R.C., 5,000 ohms, 1/2-W., 5% accuracy;
- One I.R.C., 2,500 ohms, 1/2-W., 5% accuracy;
- One I.R.C., 250 ohms, 1/2-W., 5% accuracy;
- One I.R.C., 11 ohms, 1/2-W., 5% accuracy;
- One I.R.C., 0.6-meg., 1/2-W., 5% accuracy;
- One I.R.C., 51,000 ohms, 1/2-W., 5% accuracy;
- One I.R.C., 2,400 ohms, 1/2-W., 5% accuracy;
- One wire-wound shunt, 5.5 ohms;
- One wire-wound shunt, 0.5-ohm;
- One wire-wound shunt, 0.05-ohm;

A TUBE TESTER.. A BATTERY TESTER

All for Only



\$29⁹⁵

FREE
TUBE SETTING SERVICE
FOR ONE YEAR

IN producing Model 589 there has been no compromise in the circuit design or materials. The same manufacturing methods, careful inspection and accurate calibration are incorporated in this instrument as in all other SUPREME testers. It will pay you to investigate and see this tester before you buy. Its price is the lowest at which a GOOD tube tester can be built.

Terms: \$4.00 cash and 8 monthly payments of \$3.63

MODEL 589 TUBE AND BATTERY TESTER has a completely modernized circuit. The tube test sockets are not wired directly to the circuit, but, instead, pass through the patented SUPREME Double Floating Filament Return Selector system which automatically re-connects all tube elements to any possible tube base arrangement. Due to the fact that any or all elements of each socket can be rotated to any desired position, only one socket of each type is necessary. Tests every type of tube from 1.4 volts to full line voltage at its correct anode potential under proper load. Tests separate sections in multi-purpose tubes. Checks all leakages, shorts, open elements and filament continuity with a neon lamp. A circuit insert is provided for checking noise, leakage, loose and bad connections. The battery testing circuit of the Model 589 provides the proper load at which each battery is to operate, plainly marked on the panel, for all 1.5, 4.5, 6.0, 45 and 90 volt portable radio types. The condition of the battery is indicated on an English reading scale. This is the fastest and easiest tester to operate.

MODEL 589 TUBE AND SET TESTER is very similar in appearance to the Model 589, and includes all the features and advantages of this instrument. In addition, it provides the following ranges:
 0.2 TO 1500 D.C. VOLTS—5 carefully selected ranges—0/6/15/150/600/1500 volts. 1000 ohms per volt STANDARD sensitivity.
 0.2 TO 600 A.C. VOLTS—4 A.C. ranges—0/6/15/150/600 volts. Rectifier guaranteed with instrument and fully protected from overload damages.
 0.2 M.A. TO 600 M.A.—3 direct current ranges 0/6/60/600 allow measurement of screen, plate, "B" supply and D.C. filament loads.
 0.2 TO 600 OUTPUT VOLTS—0/6/15/150/600—ideal for alignment. No button to hold down—no external condenser necessary.
 0.1 OHM TO 20 MEGOHMS—4 ranges 0/200/20,000 ohms. 0/2/20 megohms. A low range at high current with 3.5 ohms center scale.

ELECTROSTATIC—ELECTROLYTIC LEAKAGE TEST—Sensitive calibrated 20 megohm range provides excellent leakage test of paper and electrolytic condensers. Just as the 589 is your best value in a tube and battery tester, the 589 is your best value in a combination tube tester, battery tester and set tester. Remember, you have all the features of the 589 PLUS a complete AC, DC volt, ohm, megohm, milliammeter, at a cost of only 47c per range.

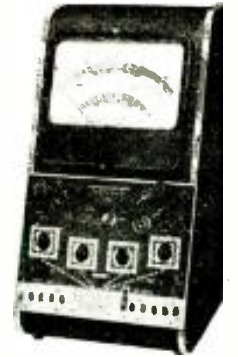

Dealer Net Cash Price \$39.50
 Terms: \$4.50 cash; 9 payments of \$4.33.

Just "follow the arrows"—you can't go wrong. Roller type tube chart with brass geared mechanism lists tubes in logical numerical order. Each tester carries a one year free tube setting service. SUPREME engineering and construction PLUS the best materials the market affords, make the 589 your biggest dollar value. You will be proud to own this instrument.

Illustrated above is the Model 589 in a counter type metal case. This model is available with option of 7" or 9" illuminated meters. Has two neon lamps for sensitive or super-sensitive tests. Write for prices and information.

SUPREME

SUPREME INSTRUMENTS CORP.
GREENWOOD, MISSISSIPPI, U. S. A.

New Catalog Just Off Press.
Write for your copy Today!

Metal cabinets as illustrated for the Model 589 at left and 589 above are identical—can be used either in a horizontal position or vertical position by merely reversing the instrument panel. Write for prices and information.

One Clarostat midget adjuster potentiometer (used as a rheostat), 2,500 ohms;

MISCELLANEOUS

- One Radio Design 0-1 ma. meter. 50 ohms internal resistance, calibrated scale;
- One Yaxley 12-position dual switch;
- One set of test leads;
- Three Amphenol tip-jacks;
- One Range bar knob;
- One Ohms Adjust bar knob;
- One Burgess 3-V. battery (smallest size);
- One Radio Design copper-oxide rectifier.

William Dubilier has suggested that robot rafts, driven and steered by electricity from a ship, be equipped with cables which when energized with 1 to 5 kw. will set up a magnetic field strong enough to cause submerged magnetic mines to automatically detonate, *Science & Culture* reported.

DR. T. O'CONOR SLOANE DIES

For many years an associate of Mr. Hugo Gernsback, publisher of *Radio-Craft*, Dr. Thomas O'Conor Sloane, scientist, editor and technical consultant, passed away at his home in South Orange, N. J., last month, at the age of 88. He held degrees from St. Francis Xavier College and Columbia University, and at one time held the chair of Professor of Natural Sciences, at Seton Hall College. His published works constitute a shelf at the New York Public Library.

Readers of Mr. Gernsback's earlier magazines will recall the work of Dr. Sloane on the staffs of *The Experimenter*, *Practical Electrics*, *Science & Invention*, and *Amazing Stories*. He also served on the staffs of other magazines, including *Scientific American*. A confidant of Thomas A. Edison, whose daughter married a son of Dr. Sloane, he made innumerable friends by his "old school" graciousness.

SOUND ENGINEERING

Free Design and Advisory Service
For Radio-Craft Subscribers

Conducted by A. C. SHANEY

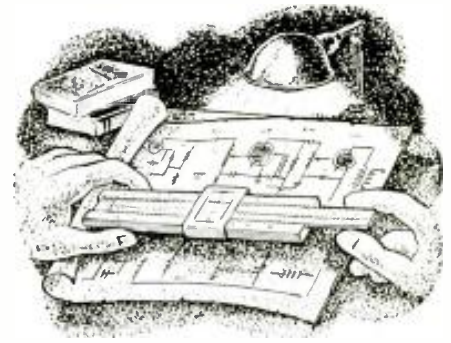

This department is being conducted for the benefit of RADIO-CRAFT subscribers. All design, engineering, or theoretical questions relative to P.A. installations, sound equipment, audio amplifier design, etc., will be answered in this section. (Note: when questions refer to circuit diagrams published in past issues of technical literature, the original, or a copy of the circuit should be supplied in order to facilitate reply.)

No. 10

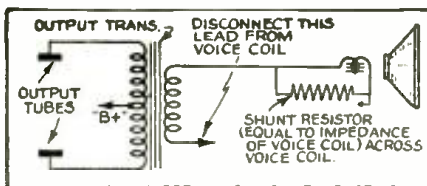

FIG. 2 ~ METHOD FOR CHECKING FOR INDUCTIVE HUM PICKED-UP BY SPEAKER VOICE COIL ~

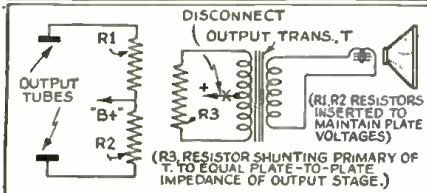

FIG. 3 ~ METHOD FOR CHECKING FOR INDUCTIVE HUM PICKED-UP BY OUTPUT TRANSFORMER ~

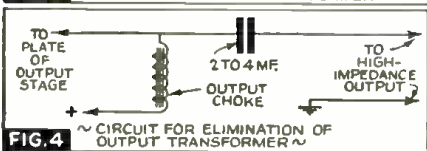

FIG. 4 ~ CIRCUIT FOR ELIMINATION OF OUTPUT TRANSFORMER ~

807 AMPLIFIER

The Question . . .

It is my intention to construct an amplifier using phase inversion in 2 separate tubes, 6C5s probably (instead of a 6N7) feeding a pair of driver tubes, then into a pair of 807s as output tubes. The reason for the 807s is that I should like the amplifier to deliver 40 watts in class AB1 with 500 volts on the plates. Then I would like to have non-selective feedback of sufficient amount to reduce the net output to between 20 and 25 watts. Since I am using a separate inverter tube, isn't it possible to feed back to the cathode of the 1st audio instead of the grid of the 2nd audio? Please furnish such a diagram and prescribe the tubes to use for the drivers. Omit the "B" supply.
LLOYD W. BUCK,
Nyack, New York.

The Answer . . .

A circuit diagram of the amplifier you desire is given in Fig. 1.

When 2 independent tubes are employed for inversion, it is feasible to apply the feedback voltage to the cathode of the input section of the inverter circuit. The degree of feedback has intentionally been made variable, so that you can easily adjust it to suit your requirements. For ideal results, a pair of 6V6G tubes should be used as push-pull drivers. The design of the driver transformer will be dependent upon the

degree of regulation in your power supply. The primary impedance of this transformer, however, should be 10,000 ohms plate-to-plate, or higher. The transformer should have a step-down ratio of at least 1½-to-1. A higher step-down ratio may cause early overload of the driver stages. As you undoubtedly have data covering the exact condition in which you intend to operate the 807 output tubes, the plate, screen-grid and bias voltages have been omitted.

It will be noted that a variable resistor, R2, is inserted in the grid circuit of one of the 6V6G drivers. This resistor will enable you to adjust for perfect inversion by connecting an oscilloscope first to one grid of the 6V6G and then to the other. When the peak voltages applied to both grids are equal, you will have perfect inversion. The variable resistor may, if desired, be removed and 2 fixed resistors inserted in its place. It will be noted that the feedback resistor, R1, is connected across the cathode resistor of the input 6C5. This shunt resistance in the cathode circuit is approximately equal to 4,750 ohms which is the required bias resistor value for the remaining 6C5 tube.

Feedback voltage may be obtained from any one of a number of sources. It may, for example, be connected to any one of the terminals of the output transformer, or it may be connected through a resistor and condenser network to one of the plates of the 807s. For best results, it should be connected to the terminal of the output transformer in use. For example, if an 8-ohm speaker is to be employed with this amplifier, the feedback voltage lead should be connected to the 8-ohm tap. This will insure direct compensation for changes of impedance with frequency of the output tubes, and will automatically compensate for discrimination in the output transformer.

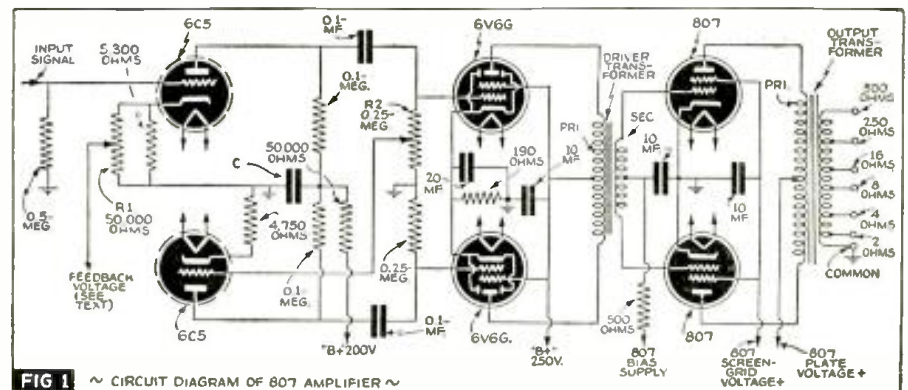

FIG. 1 ~ CIRCUIT DIAGRAM OF 807 AMPLIFIER ~

HUM BY INDUCTION

The Question . . .

A customer brought in a combined R.F. Tuner and P.A. Unit, which he uses for recording and playing-back radio programs. He wants the A.C. hum reduced to a minimum and a tuning eye installed.

Looking over this assembly, I found a few defects in placements of parts, but I am not sure of these defects, and I wish you would give me some advice.

(1) How far should a 10-in. P.M. speaker be mounted away from a power transformer, output transformer, and filter choke? As it is now, the power transformer is only ¼-in. away, the output transformer about ½-in., and the filter choke is 1-in. away.

(2) Will the P.M. speaker interfere with the flux lines of the transformers and will it introduce hum in the output?

(3) Is there any advantage of using the output transformer secondary?

(4) Could an absolute humless amplifier be built?

(5) Is there any advantage of having a separate filament transformer?

I'm a steady reader and subscriber of R.-C. since 1929.

P. H. KLEIN,
Superior Radio Service,
Chicago, Ill.

The Answer . . .

(1) It is difficult to state any empirical rules relative to distances between components for minimum hum pick-up, as the flux density produced by the various items involved, as well as their placement, construction, and shielding, will influence safe distances between components. The best procedure to follow in locating objectionable inductive hum pick-up in your particular case, is to check each component for the amount of hum it contributes.

When a power transformer is placed sufficiently close to a loudspeaker, stray flux may cut the voice coil windings in such a manner as to directly induce hum into the speaker. This can easily be checked by dis-

connecting the voice coil from the secondary of the transformer and shunting the coil with a resistor equal to its impedance, as illustrated in Fig. 2

The disturbing element may be located by removing the filter choke from the chassis (be sure to keep it connected in the circuit). If hum persists, it is obvious that the power transformer is incorrectly orientated in relation to the speaker, or it may be too close.

The hum-producing effect of the filter choke can easily be checked by placing it back on to the chassis in its original position. If no increase in hum is heard, then the filter choke may safely be left where it originally was. On the other hand, you may find it necessary to change its position, or distance.

Hum picked up by the output transformer can easily be checked by disconnecting the plate leads from the tubes and substituting plate feed resistors for the output stage, so as to maintain the same voltage at the plates of the output tubes. A suitable resistor, equal in resistance to the impedance of the primary of the output transformer, should then be placed across the output transformer, as illustrated in Fig. 3.

Any difference in hum between the tests indicated in Figs. 2 and 3 will be indicative of inductive hum picked up by the output transformer. The plate resistors are used in making this test so as to insure the proper drain on the power transformer. This also guards against variation in stray power transformer flux when the power tubes are disconnected from the output transformer. In making the second test, the filter choke should similarly be removed from the chassis to see what effect its position has upon the inductive hum picked up by the output transformer.

Chokes used in choke-input filter circuits will usually create greater magnetic disturbances than chokes employed in conventional condenser-input filter circuits. Should you find that there is a negligible inductive hum but a decided hum when the output transformer is connected into the plates of the output stage, your trouble may be in insufficient filtering in the power supply. On the other hand, it may be one of a number of sources from the detector circuit on. If you will refer to the August, 1939, issue of *Radio-Craft* ("Obscure Sources of Hum"), you will find a number of other common hum sources indicated.

(2) The proximity of the speaker to the power transformer may produce mutual interference. That is, stray flux lines from the transformer may pass through the magnetic structure of the speaker, or through the voice coil, as outlined under (1). The chances are, however, that the transformer will interfere with the speaker by diverting some D.C. flux through the transformer and chassis. This will, of course, reduce the efficiency of the speaker. The exact reduction in efficiency, however, will depend upon the construction of the speaker and the proximity of the magnetic material to the speaker.

(3) It is necessary to use the output transformer secondary if you are coupling from the plate circuit of a tube to a low-impedance voice coil, as this is the only method of obtaining an efficient impedance transformation. If, however, you desire to couple from the plate circuit to another high-impedance device having an impedance nearly equal to the impedance of the output circuit, then you may use an arrangement, as illustrated in Fig. 4. This arrangement is sometimes employed for coupling the output stage to a crystal loudspeaker.

(4) An absolutely humless amplifier can easily be built. The simplest way of attain-

ing this result is to use batteries for heater, plate, and screen-grid circuits. It is, of course, also possible to produce a humless amplifier by using well-filtered plate supplies and well-filtered D.C. for heater circuits. Ordinarily, an *absolute* humless amplifier does not mean a quiet amplifier, because tube noise may be appreciably higher than hum in a high-gain amplifier. It is therefore impractical to bring the hum level far below tube noise.

(5) In some high-gain amplifiers, it has been found advantageous to employ a separate winding for the preamplifier tubes. This winding should have its own variable resistive center-tap for independent adjustment for minimum hum. If an auxiliary filament winding is not available, and a separate filament transformer is employed, care should be taken to avoid the introduction of inductive hum into other circuits by this auxiliary transformer.

WANTS MORE HI-FI T.R.F.

Dear Editor:

I have been a constant reader of "Radio-Craft" for over 2 years and wish to say *there is nothing to compare with it.*

It is indeed a Serviceman's magazine—so let's keep it that way, eh?

During the last few months especially, I have enjoyed nearly every article printed. I say—"Give us more hi-fidelity in all phases—amplifiers and receivers both. And, incidentally, since F.M. is a bit out of the range of most of us right now, how about a few more hi-fi T.R.F. circuits? Small, low or moderate power transmitters are OK but please don't sacrifice any of the fine Servicemen's articles for short wave dope.

"Trouble-shooting," and "Intermittent Hunting," items are always welcome.

JEROME GUGGEMOS,
Birchwood, Wis.

IT'S RCA FOR UNMATCHED QUALITY..UNBEATABLE LOW PRICES!

Your BEST Bridge Between
Amplifier and SOUND!
RCA QUALITY SPEAKERS



Power Sound Projector.
Handles 100 Watts—
projects to 4,000 feet.
MI-6256.



12" P.M. Dynamic—
Handles 10 Full Watts
with high quality.
MI-6247A.



Directional Sound Baffle.
Efficient. Wide Angle.
MI-4423 for 12" Speaker.

YOU KNOW... and we know... that sound reproduction quality is more often marred by the speaker than by any other element in the system! That's why good speakers are your best Sound Investment!

Who makes the best speakers—? RCA. Why—? Because the extensive research of the greatest name in radio has found the best answers to problems of speaker design and manufacture. When you buy a modern RCA Speaker, you buy *low distortion*—for extra clarity in speech and music. You buy uniform, extended *frequency-response*—for higher-fidelity. You buy higher audio-to-sound *conversion efficiency*—for greater coverage with smaller amplifiers... for more actual Decibels from your Watts!

And because of the tremendous mass-production facilities of RCA, prices are pleasingly *low!* Believe your ears—*hear* RCA Speakers at your RCA Distributor's this week!



High Output—High Quality! 15" Permanent Field Dynamic. MI-6237.



Auditorium Wall Speaker Cabinet—for MI-6237, or other 15" P.M. Dynamic. MI-6223.



Revolutionary! New RCA Accordion Edge Speaker. "Bellows Action." MI-6234.

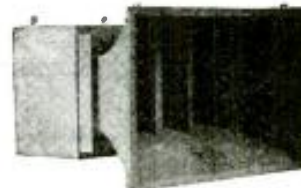

Wide Angle Baffle. Efficient. Wide Angle. MI-4420 for 12" Speaker.



Commercial Sound

RCA Mfg. Co., Inc., Camden, N. J. • A Service of Radio Corporation of America

Any Sound System Sounds Better Equipped with RCA Radio Tubes

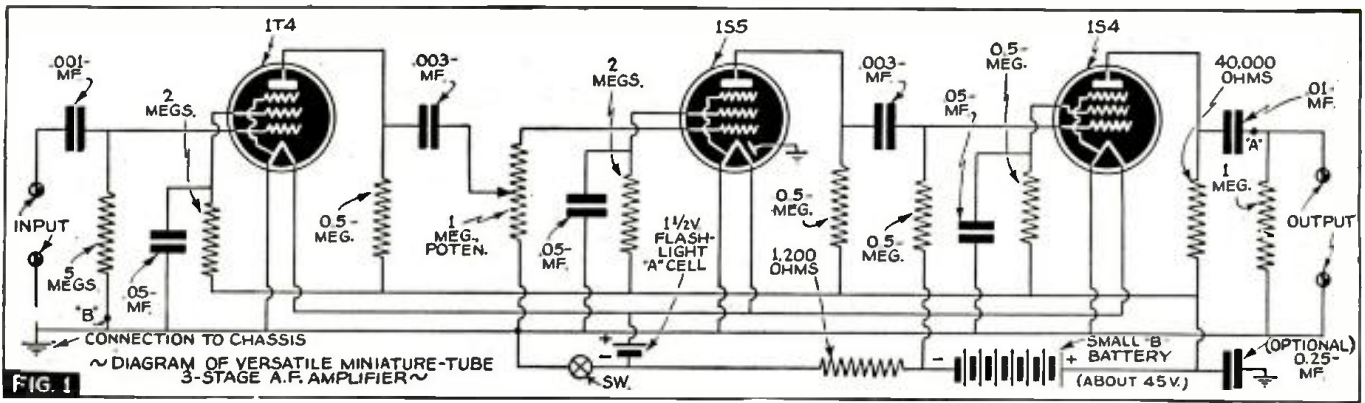

How to Make a Versatile MINIATURE-TUBE AUDIO AMPLIFIER

The following article will be of unusual interest to the average radio man for several reasons. First, it includes complete construction details for an A.F. amplifier incorporating the new miniature battery tubes. Second, the circuit arrangement has been selected with a view to wide utility. Third, a number of applications for which such a small-space A.F. amplifier is particularly suitable are discussed by the author.

H. G. CISIN, M.E.



Front view of the completed amplifier. The equipment associated with it helps show comparative size. It may be used with headphones, if desired, as illustrated. Suggesting its utility are the crystal sound mike and crystal vibration unit at left.

ALTHOUGH the miniature "button"-bottom tubes have only recently emerged from the experimental laboratory, it is possible to employ them in many types of electronic apparatus with the utmost efficiency, especially where compactness and portability are important factors.

Of the 4 new miniature tubes designed for radio receiver use now available, 3 lend themselves particularly to amplifier design. The 1T4 pentode amplifier tube is especially well suited for use in an input or preamplifier stage. The 1S5 diode-pentode may be used to advantage as a 2nd stage amplifier, since it has a voltage gain of approximately 30. The diode rectifier of this tube is also available for automatic volume control, where this feature is an essential requirement. The 1S4 power amplifier pentode serves as an excellent output tube. It has a maximum signal power output of 0.065-watt, and when correctly used in a 3-stage Class A₁ amplifier, results are extremely gratifying.

VERSATILITY

The high-gain, low-watts-power, battery-operated portable amplifier, such as the one

described in this article, has a vast field of applications. In fact, the money-making opportunities in this field are great, since the surface has merely been scratched. An amplifier of this type has uses in many specialized fields, where result, rather than price, is the primary consideration. A few more or less obvious applications are suggested here, but many more will occur to the wide-awake radio man.

In the industrial field, this portable amplifier may be used with a piezoelectric (crystal) Vibration Pickup for the production testing of all kinds of bearings, crankshafts, assembled generators, motors, gear trains, transformers, compressors, refrigerators, washing machines, fans, vacuum cleaners, air-conditioning apparatus, etc. Used with this type of pickup, it may also locate sources of noise or vibration in any reciprocating or rotating machine. In airplane factories, it may be used to determine the vibration of airplane wings and in motor car production, it finds application in locating vibration in automobile bodies. Other industrial uses along these lines are the location of water leaks and the measurement or the transmission of vibration through different materials. Headphones are used for supplying the audible indication, although voltmeter, sensitive relay or oscilloscope may be employed for other types of indicators.

Used with a sensitive crystal microphone and with sensitive crystal headphones, this amplifier is ideal for detective work. Its superiority to the old-fashioned carbon mike telephone circuit is so marked, that there is scarcely any basis for comparison. With a device of this type, all conversations are clearly distinguishable and it is possible to recognize familiar voices, even though the microphone is located at a considerable distance from the source of the sounds. In fact, very good results may be obtained with the microphone hidden in a bureau drawer or behind a closet door. With the device described in this article, it was possible to hear the ticking of a high-grade wrist watch, when the watch was placed

almost a foot away from the microphone.

As a hearing-aid, this amplifier is in a class by itself. The instrument shown in this article was tested for this purpose under the most difficult conditions. The subject of the test was a person who depended upon lip reading, due to the inability of ordinary hearing-aids to give relief. Without the instrument, one could get behind this near-deaf person and shout as loudly as possible without being heard. With this amplifier, however, the "hard-of-hearing" person was able to hear and understand every word spoken behind his back. Moreover, it was not necessary to shout, but merely to talk in a normal tone of voice. Incidentally, the subject of this test was overjoyed with the results obtained. In adapting the amplifier shown for use as a hearing-aid, it is suggested that the microphone be incorporated with the amplifier and that the batteries be located in a separate container. It may be found desirable to modify the circuit slightly, as discussed later on in this article, although in general, no basic changes are necessary. The use of extremely small fixed resistors and condensers, instead of the standard ones shown, will help to make the hearing-aid ultra-small.

As a general laboratory accessory, this amplifier has innumerable uses. It will be found of great value in many kinds of experimental and research work. This statement applies not only to the electrical and radio laboratories, but also experimental laboratories in many other fields. Schools and colleges especially should find many uses for an amplifier of this type.

DIAGRAM

The schematic diagram shown as Fig. 1 gives the details of the hook-up employed in the Versatile 3-Stage Amplifier. It will be noted that this is a more or less standard resistance-capacity coupled circuit. However, the values of the resistors and condensers have been selected carefully in order to obtain maximum results. Volume is controlled by means of a 1-megohm poten-

tiometer which controls the input to the 1S5 tube.

This amplifier has been designed particularly for use with a crystal microphone at the input and crystal earphones at the output. Any type of crystal microphone may be employed, depending upon the purpose for which the amplifier is to be used. It will be noted that the output is well isolated from high voltage, so that there is no danger of harming the delicate crystal earphone.

The basic circuit shown lends itself to a number of variations to meet specific requirements. If it is desired to maintain constant power output with changes in signal level, this may be accomplished through the use of automatic volume control (A.V.C.). This feature is desirable quite often, in hearing-aid amplifiers.

An A.V.C. circuit may be obtained by connecting the diode of the 1S5 to a point marked "A" on the diagram. It is also necessary to insert a 0.05-mf. condenser in series with the 5-meg. resistor at the point marked "B". A 10-meg. resistor is connected at the point where the 5-meg. resistor connects to the 0.05-mf. condenser. The other end of this 10-meg. resistor is also connected to the diode of the 1S5. In this way, instantaneous peak positive potentials are passed from diode to heater, and on to ground. The negative components of the output build up across the 0.05-mf. condenser through the 10-meg. isolating resistor. Naturally, the A.V.C. "starting" time is a function of the series resistor and the 0.05-mf. condenser. By reducing the value of the resistor, the starting speed is increased. Conversely, by increasing the size of the condenser, the starting speed is reduced. In order to increase the release time speed, a 1/4-meg. resistor should be connected across the output terminals in place of the 1-meg. resistor. Without this resistance, the only discharge path is through the flow of grid current in the input tube and through other leakage paths, so that the release time would be very slow. Release time is increased by increasing the value of the resistor across the output terminals and it is decreased by decreasing the value of this resistor.

In order to convert this amplifier to one of lower gain, the 1T4 may be resistance-capacity coupled directly to the 1S4 tube. In such a circuit, it may then be necessary to employ a higher-level microphone. (It is also possible to add an additional stage to this amplifier and the method of doing this may be outlined in a future article.)

It will be noted from the schematic diagram that the required 4 1/2-volt negative bias for the 1S4 tube is obtained through the use of a 1,200-ohm resistor, rather than by using a 4 1/2-volt "C" battery. As a matter of fact, bias is not absolutely essential in this instance, and the 1,200-ohm resistor may be omitted, without materially reducing the working efficiency. The 0.25-mf. condenser bypassing the positive side of the "B" supply to ground is optional. Omission of this condenser will have no effect if the

The versatile miniature-tube audio amplifier removed from its case. The batteries which make this a completely self-powered unit are shown. Note how the new miniature tubes afford an unusually compact assembly. Reference to the circuit, Fig. 1, will show how the need for bulky equipment has been eliminated.



batteries are always kept comparatively fresh.

XTAL SOUND MIKE

The small microphone shown in the foreground, in the photograph, is an Astatic type R-3 crystal (xtal) microphone, designed to be connected directly to the grid and the ground of the input tube. This connection is possible due to the high impedance of the mike. Of course, when connected in this way, it is important that a parallel resistance or gridleak of not less than 5 megohms be used. If a resistance of lower value should be used, this would reduce the low-frequency response.

Transformer matching is necessary where it is desired to use this microphone at a distance of more than 50 feet from the amplifier. The winding next to the microphone should have an impedance of approximately 0.1-meg. Figure 2 shows how this type of transformer coupling may be accomplished.

In using crystal microphones, it is important that no D.C. voltage should appear across the crystal, as this would surely cause damage to the instrument. When using the microphone near strong radio-frequency currents, a well-shielded cable should be used. Crystal microphones should not be used in places where the temperature is above 120° F.

XTAL VIBRATION MIKE

The instrument with the long metal rod shown in the amplifier photograph is a Model VP-5 Brush piezoelectric Vibration Pickup. In using this pickup, the pointed end of the long rod is held tightly against the vibration surface under test. Large ampli-

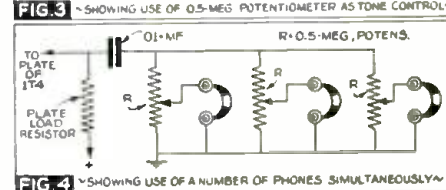
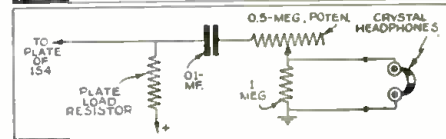
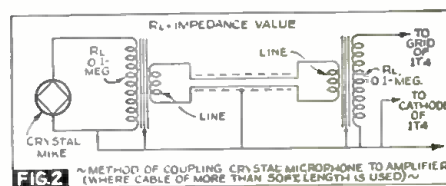

tudes of vibrations cannot harm the pickup. A few uses of this type of pickup in connection with the Versatile Amplifier are suggested below.

This device is a crystal pickup of the inertia type which delivers a voltage proportional to the acceleration it receives when applied to a vibrating body. The frequency of the voltage will be the same as that of the vibration if the latter is of simple harmonic nature. If it is complex, the harmonics will be magnified in a manner shown by the response curve of the pickup. The important feature is the fact that the response curve follows closely the noise-making characteristics of the object under test. This type of pickup is especially de-

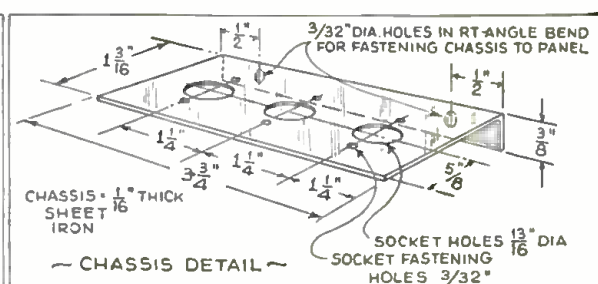
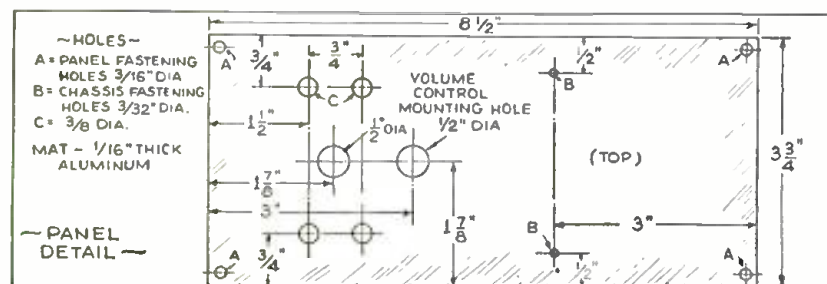

The Best Equipped Shop in Town
"GETS THE BUSINESS"

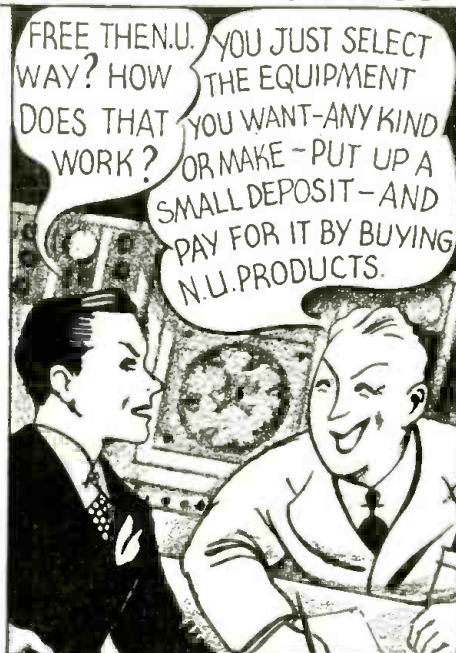

NATIONAL UNION
NEWARK, NEW JERSEY • *Radio Corp.*

See Page 198 for Important Announcement on Radio Service Manuals



FREE!

**HAMMARLUND
NEW "40"
RADIO CATALOG**

The latest Hammarlund catalog with complete data, illustrations, drawings and curves on the entire Hammarlund line. Address Department RC-104 for your free copy.

HAMMARLUND MFG. CO., INC.
424-438 West 33rd Street, New York City

CORRECTIONS

A few component values required to complete several articles appearing in this issue of *Radio-Craft*, but received too late for inclusion in the original stories, are given here. See Service Data Sheet No. 288. In the service diagram, condenser C47 is a 1-mf. unit. In the Sound Engineering section, pg. 254, the value of condenser C, Fig. 1, is 10 mf. In *The Radio Month* in Review department, pg. 200, no figure is given for the rated watts power of the Aragon Ballroom P.A. system. This rating is 50 watts. The diagram below is a correction (arrow) for the Scott Phantom Deluxe receiver diagram shown on pg. 172 of the Sept., 1940, issue.

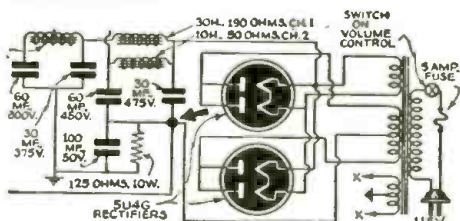

sirable for use where high-frequency components are to be indicated. No moving parts are required to actuate the crystal generator in this type of instrument. The VP-5 inertia pickup is designed for frequencies up to 1,500 cycles per second. Another type, the VP-1 is available for frequencies up to 5,000 cycles per second.

The vibration pickup may be connected directly to the input of the Versatile Amplifier in the same way as a crystal microphone. The grid resistor of the Versatile Amplifier is a 5 megohm resistor and this happens to be the recommended value for the VP-5 pickup. The choice of the grid resistance is governed by the lowest frequency to be observed. To prevent attenuation of the low frequencies, the grid reactance should be several times the capacitive reactance of the pickup at the lowest frequency to be observed. The impedance of the VP-5 at 23° C. is 0.005-mf. This, of course, is a capacitive reactance. The sensitivity of the VP-5 is 2 volts r.m.s./0.001-in. motion at 500 c.p.s.

XTAL PHONES

The Versatile Amplifier has been designed particularly for use with crystal headphones. While available with various special features, headphones of this type are all high-impedance, voltage-operated devices. The phones shown in the illustration are of the latest Brush Communication type, Model B-J. These operate in the range from 100 to 10,000 cycles per second. As with other crystal phones, the impedance is capacitive and may be calculated at any frequency using the value of 0.004-mf. for a single phone and 0.008-mf. for a pair. The impedance at 500 cycles therefore, is 40,000 ohms. Due to the high impedance of these crystal headphones, they do not alter the characteristics of the amplifier circuit. The power requirement of this type of phone is very low and an r.m.s. audio potential of 10 to 20 volts applied to the phones will be found to be fully adequate. It may be seen from the schematic diagram, Fig. 1, that a 0.01-mf. blocking condenser is used in series with the phones and that they are shunted with a 1-meg. resistor. Due to the wide frequency range, it may be desirable to use a tone control to reduce extraneous noises such as high audio frequency interferences. This control may be a 5-megohm rheostat placed in series with the phones as shown in Fig. 3.

If 2 or more xtal earphones are to be used, as shown in Fig. 4, the individual volume control for such multiple installations may consist of variable resistors of a value on the order of 50,000 to 500,000 ohms. The number of phones used determines the exact value of each control. The value of the blocking condenser must be increased as more and more phones are employed. In using crystal phones, it should always be kept in mind that they should not be subjected to D.C. potentials, or to temperatures above 120° F.

CONSTRUCTIONAL DETAILS

The Versatile Amplifier is built into a wood case 8 3/4 x 4 1/4 x 4 ins. high. See Fig. 7, A to F, incl. This case is made of 1/4-in. 3-ply wood. It is large enough for the amplifier and the batteries. The panel is made of a piece of 1/16-in. aluminum 8 1/2 x 3 3/4 ins. wide. The 4 insulated phone tip-jacks are mounted on the panel, as shown in Fig. 5. The 2 jacks at the left are for input connections; the 2 at the right are for the output. The volume control and "on-off" switch are also fastened to the panel.

The chassis consists of a small piece of sheet iron with a single right-angle downward bend at the rear, for fastening to the

back of the panel (Fig. 6). The 3 socket holes and the 3 socket mounting holes are drilled in the chassis; and also, the 2 chassis mounting holes in the rear bend. The chassis is then fastened to the back of the panel by very small flat-head machine screws.

The wiring is very easily performed. It will be noted that the 1T4 tube socket has 2 F-terminals; the 1S4 tube has 2 plate terminals and 2 F-terminals. These facilitate wiring, as the terminal which is most accessible may be used. The utmost precaution should be observed to keep from dropping any small pieces of solder between the terminals. These are so close, that a drop of solder may readily result in a burned-out tube. In order to make a very neat looking wiring job, it is recommended that a 4- or 5-terminal resistor rack be fastened to the rear of the panel, about 1 in. below the chassis. The various condensers and resistors are then fastened between the underside of the chassis and the resistor rack.

A careful check should be made with a voltmeter after the batteries have been connected, but before inserting the tubes. After having made sure that there are no high voltages on the filament circuits, the tubes may be placed in their respective sockets. Incidentally, in laying out the set, it is desirable to have the 1T4 tube at the left of the chassis, when facing the rear of the panel. The 1S5 is in the center and the 1S4 is at the right. In this way the input connections will be on the same side as the input jacks and the output wiring will also be near the output jacks. The tubes should be inserted in the sockets without using force, but should be pressed down firmly so that they go all the way into the sockets and thus make proper contacts.

The "B" battery used has a socket which takes a 3-point polarized plug. This plug is permanently wired to the high-voltage and "B"-minus points of the amplifier. Thereafter, changing of the "B" battery, merely means taking the plug from the old battery and inserting it in a new one.

Since an ordinary flashlight cell is used for the "A" supply, it is desirable to construct a small holder, so that the "A" cell may be replaced as readily as the "B." The construction of this simple battery holder is shown in Fig. 9.

The brass strap which holds the battery firmly in place, between the 2 end supports, is permanently fastened on one side and is held in place by a small thumb nut on the other side. Removing the thumb nut permits the strap to be moved away, so that a new battery may be slipped into place without changing any connections. The "A" cell connections are soldered to each of the end supports.

DIRECT - COUPLED AMPLIFIERS



"The Ultimate in Design"

These new 10, 20 and 30 Watt Direct-Coupled (Push-Pull Loftin-White) Amplifiers are now available with any one or more of 14 optional features, including Variable Speed Non-Overloading Push-Pull Expander, High Frequency Accentuation and Attenuation, Low Frequency Boost and Cut Control, Push-Pull Automatic Volume Compressor, Push-Pull Automatic Volume Limiter, Push-Pull Automatic Volume Control, Non-Frequency Discriminating Scratch Suppressor, Low-Gain Single Ended Input, High-Gain Single Ended Input, Low-Gain Push-Pull Input, High-Gain Push-Pull Input, Audio Spectrum Control, Calibrated Volume Indicator, and Push-Pull Remote Control.

Write or Wire Today for Complete Details and Unusually Attractive Prices.

AMPLIFIER CO. of AMERICA

17 WEST 20th STREET NEW YORK, N. Y.

NEW AUDIOGRAPH Sound Catalog

AUDIOGRAPH Sound Systems represent the latest in Sound Engineering and Design—a complete line plus pre-tested accessories.

NEW LOWER PRICES

Outstanding quality and performance at prices that help you meet any competition.

WRITE FOR FREE COPY

JOHN MECK INDUSTRIES
1313 W. Randolph St. Chicago, Ill.



NEW HAND SET — AIRCRAFT TYPE

... for mobile, pack transmitters, amateurs, aircraft, 2-way phone systems, etc. Durable, long life, low price. Black Bakelite case with 6 ft. cord. Microphone and receiver terminated separately. Switch not available. Wt. complete only 7 oz., packed 1 lb., 75 ohms match line impedance; 2,000 ohms match plate circuit of output tube. Higher resistance.

UNIVERSAL MICROPHONE CO. \$10.00
Ltd., Inglewood, Calif., U.S.A. List

CONCLUSION

Just a few words with reference to the finish of the case and panel. Before being wired, the panel was painted with Egyptian lacquer, resulting in an attractive black crackle finish. The case was painted with a good-quality black enamel. Several coats were applied, each coat being sanded down before application of the next coat.

After all tests have been completed, the batteries are inserted in the case with all connections made from the amplifier. To prevent the batteries from moving around, enough paper is inserted between them to make them stay firmly in place. The piece of wood which separates the batteries from

Figure 9.

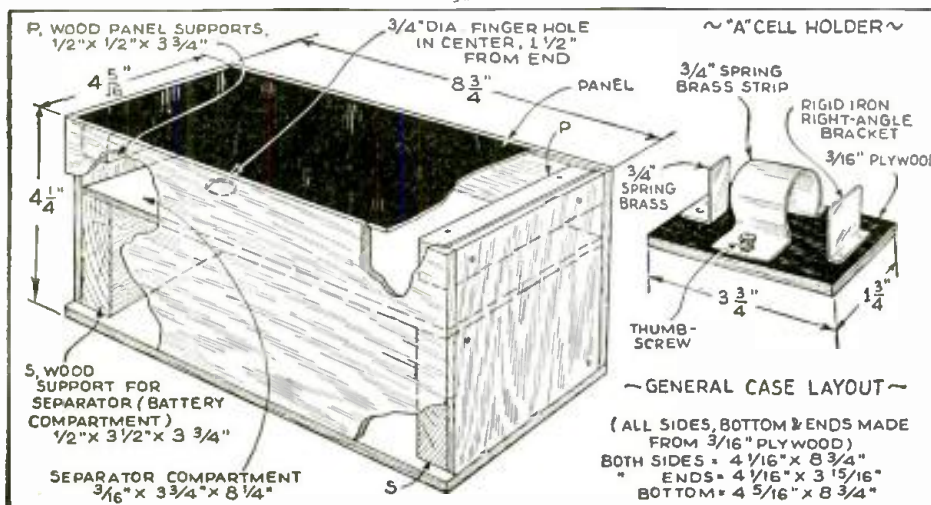

The NEW DOENUT Horn

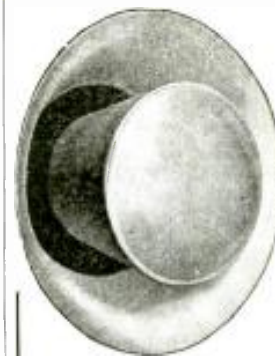

Provides Wider Angle Coverage

Model DX8BX

List Price **\$36.40**
15 Watts

- Spreads high frequencies over a wide angle.
- Weatherproof.
- Wide frequency range.
- No metallic sound.
- High conversion ratio
- Low feed-back ratio
- Sturdy steel construction

Write for complete details

WRIGHT-DeCOSTER, Inc.

2251 University Ave., St. Paul, Minn.
Export Dept.: M. Simons & Son Co., New York
Cable Address: "Simontrics"

Canadian Representatives:

Wm. F. Kelly Co., 1207 Bay St., Toronto, Ontario
Taylor & Pearson, Ltd., Edmonton, Alberta

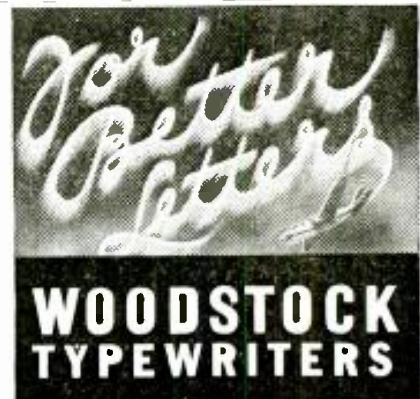

EYE APPEAL! EAR APPEAL!! PRICE APPEAL!!!

The MUSIC MASTER all electric high fidelity phonograph has everything you need to sell more records. The tone is so good that it is widely used by dealers as a counter or booth record demonstrator. Quality crystal pickup, self starting silent rim drive motor (also in 25 cycle and AC-DC) high fidelity amplification and PM speaker. Retail at \$14.95. Dealers write for attractive proposition.

MUSIC MASTER MANUFACTURING CO.
508 S. Dearborn Chicago, Ill.
Phonographs . . . Home Recorders . . . Needles

the amplifier (see Fig. 8) is next inserted in the case. Finally the amplifier is placed in the cabinet with the panel flush with the top. The panel rests on 2 wood supports. It is fastened to these supports by means of 4 flat-head wood-screws.

LIST OF PARTS

CONDENSERS

- One Cornell-Dubilier, 0.001-mf., type DT-6D1;
- Two Cornell-Dubilier, 0.003-mf., type 6D3;
- One Cornell-Dubilier, 0.01-mf., type DT-4S1;
- Three Cornell-Dubilier, 0.05-mf., type DT-4S5;
- One Cornell-Dubilier, 0.25-mf., type DT-4P25;

RESISTORS

- One I.R.C., 1,200 ohms, 1/3-watt;
- One I.R.C., 40,000 ohms, 1/3-watt;
- One I.R.C., 0.3-meg. 1/3-watt;
- Three I.R.C., 0.5-meg. 1/3-watt;
- One I.R.C., 1 meg., 1/3-watt;
- Two I.R.C., 2 megs., 1/3-watt;
- One I.R.C., 5 megs., 1/3-watt;

- One Centralab Sub-Midget Potentiometer, 1 meg.;
- MISCELLANEOUS
- Four American Radio Hardware insulated phone tip-jacks;
- One S.P.S.T. toggle switch;
- One Astatic microphone, type R-3;
- One Brush piezo-electric vibration pickup, type VP-5;
- One set Brush crystal earphones, type BJ;
- One Sylvania type 1T4 tube;
- One Sylvania type 1S5 tube;
- One Sylvania type 1S4 tube;
- Three Cinch sockets for Sylvania miniature tubes;
- One "On-Off" etched plate for switch;
- One "Volume" dial;
- One knob;
- One aluminum panel; 1 iron chassis; 1 wood case (For dimensions see sketches.);
- One resistor mounting rack;
- One "B" battery, Acme 45-V., type No. 830;
- One Eveready "A" cell, 1½ V. flashlight type No. 950;
- One "A" cell holder (See sketch, Fig. 9);
- One 3-point polarized plug for "B" battery connection.

F.C.C.—RADIO CALL LETTERS

Their Origin and Their Allocation

THE Federal Communications Commission now has approximately 65,000 active radio call letter assignments outstanding, exclusive of Government stations.

In round figures, this includes some 800 standard broadcast call letters; 600 broadcast other than standard; 400 experimental; 3800 ship radio; 1800 aviation radio; 1100 police radio; 250 forestry radio; 54,000 amateur radio; 300 coastal radio; 800 fixed

radio, and the rest miscellaneous.

Licensing of both radio stations and operators is now according to a definite plan. This is in contrast to the early days of radio when there was little or no system.

At the turn of the century it became apparent that radio (or, as it was then called, "wireless") stations should have certain designated letters in order to avoid confusion. The Berlin international radio convention of 1906 proposed such a system, effective in 1908. This convention was not ratified by the United States until 1912, consequently the procedure of assigning call letters was not followed in this country until after that time.

Under the international system, the first letter or the first 2 letters of the call signals indicates the nationality of the station. Ratification of the Berlin convention gave the United States use of 3 letters—N, K and W. Hence the present domestic assignment of combinations beginning with those letters. These are allocated by the Federal Communications Commission as follows:

Call letters beginning with N are reserved for the exclusive use of the United States Navy and the United States Coast Guard.

Call letters beginning with K are assigned to stations located west of the Mississippi River and in the territories of the United States.

Call letters beginning with W are assigned to stations east of the Mississippi River. (There are a few exceptions.)

Call letters beginning with KH followed by various combinations of three letters are reserved for aircraft radio stations.

Prior to radio regulation, stations used whatever call letters struck their fancy. Thus, a commercial station at Point Judith, Rhode Island, used PJ, and one in New York City adopted NY. Enactment of the pioneer radio act in 1912 reassigned calls and did away with duplication.

During the infancy of radio practically all land stations were on the coast and all communication was between ship-to-shore stations. As inland stations developed, the Mississippi River was made the dividing line of K and W calls. KDKA, at East Pittsburgh, Pa., is one of the early broadcast stations which were assigned the K letter before the present system was put into effect.

Most of the early call letter assignments were for 3 letters. About the time we en-

JUST PUBLISHED!

A NEW BOOK TO ADD TO YOUR TECHNICAL LIBRARY

AUTOMOBILE RADIO — Principles & Practice

by B. Baker Bryant



A COMPLETE compilation of pertinent data on how to install and service the modern automobile radio receiver. All of the non-essential details which have crept into the profession have been weeded out. Each topic is treated so as to contain a precise statement of the fundamental principle involved, to assure the reader's clear understanding of this principle, without distracting his attention by the discussion of a multitude of details and mathematical expressions, which are primarily for the engineer, and tend to confuse rather than clarify a statement for the auto-radio-technician. A practical treatise based on practical experience by practical radio people for the practical radio-technician.

Brief Outline of Contents—

- Introduction—The Auto-Radio Art.
- Features of the Modern Automobile Receiver.
- Installations of Automobile Radio and Antenna.
- The Automobile High and Low Tension Electrical Systems.
- Automobile Electrical Disturbances.
- Vibrator Converters and Motor Generators.
- Service Hints, Classified Automobile Installation Notes, and Conclusion.

Send 50c check, money order, unused U. S. stamps, or coin for your copy of "Automobile Radio—Principles & Practice"—it will be sent to you postpaid upon receipt of your remittance.

RADCRAFT PUBLICATIONS, Inc.
20 Vesey Street, New York, N. Y.

50c
POSTPAID
Size—6 x 9
Inches
64 Pages
Stiff, flexible
cover
Numerous
illustrations
and
diagrams

tered the World War this combination had become exhausted, making it necessary to add another letter. The international radio conference in 1927 allocated the remaining combination beginning with *KA*, *KB* and *KC* to the United States. Four-letter calls under this convention are assigned to ships and fixed stations in domestic point-to-point service and 5 letter calls are given to radio-equipped aircraft.

All classes of experimental stations are assigned calls with the initial letter *K* for outside stations and *W* for those within the continental limits of the United States, followed by a number designating the radio district, followed by the letter *X* to denote experimental, followed by a group of not more than 2 letters.

RADIO DISTRESS CALLS

Use of "SOS" in Radiotelegraphy and "Mayday" in Radiotelephony Recognized by both Domestic and International Regulations.

The distress call "SOS" famous to radiotelegraphy was first officially adopted for international use at the 1906 International Radio Conference at Berlin, although prior to that date the calls "CQ" and "CQD" had been employed during certain periods after 1900 when the Marconi International Marine Communication Company, Ltd., began equipping ships for radiotelegraph communication.

A distress call for use in radiotelephony was proposed by the British delegation at the Berlin conference and the word "Mayday," corresponding to the French pronunciation of the expression "m'aider" (meaning "help me"), was first officially approved for international use in radiotelephony at the International Radiotelegraph Convention held at Washington in 1927. Guiding factors in the choice of the spoken word "Mayday" for the purpose mentioned were its similarity in meaning to the "SOS" used in radiotelegraphy, and the prevalence of the use of the French language.

Both domestic and international regulations specify the manner in which the distress calls ("SOS" for radiotelegraphy and the spoken word "Mayday" for radiotelephony) shall be utilized. Article 24 of the General Radio Regulations, International Telecommunications Conference, Cairo, 1938, provides in part that

"... The distress call and message shall be sent only by order of the master or person responsible for the ship, aircraft, or other vehicle carrying the mobile station ...

"... Furthermore, a mobile station which becomes aware that another mobile station is in distress, may transmit the distress message in either of the following cases:

- (a) when the station in distress is not itself in a position to transmit it;
- (b) when the master (or his relief) of the vessel, aircraft, or other vehicle carrying the station which intervenes, believes that further help is necessary."

The use of the distress call is further restricted by Section 325 of the Communications Act of 1934, as amended, which provides in part as follows:

"(a) No person within the jurisdiction of the United States shall knowingly utter or transmit, or cause to be uttered or transmitted, any false or fraudulent signal of distress or communications relating thereto ..."

A fine of not more than \$10,000 or imprisonment for a term of not more than 2 years, or both, is provided by Section 501 of the Communications Act for violation of these provisions.

ALLIED'S 1941 RADIO CATALOG

Shows Everything New in Radio!



FREE

212 PAGES

100% RADIO

DEPEND ON ALLIED—
THE WORLD'S
LARGEST EXCLUSIVE
RADIO HOUSE!







83 NEW RADIOS!

Nothing like it in all Radio! New style plastic and wood table models—new world-wide sets—new "Camera" and 3-way Portables. Also newest 1941 low-cost Phono-Radio-R corders, Combinations, Phono Players and Accessories, Auto Sets—all at amazingly low prices—Bix special 40-page section!

NEW SOUND SYSTEMS!

1941 P.A. design—types for every Sound application. 24 new Systems—7 to 75 watts—new illuminated panels. "Safused" Speakers and other exclusive features. Lowest P.A. prices! Attractive Time Payment Plan—15 Day Trial Offer. Complete line of P.A. accessories—all in a big special 35-page P.A. Section!

NEW SERVICE SECTION!

128 value-packed pages devoted to all the new Test Equipment—new tools—new Service books—more than 15,000 quality Radio parts for every radio purpose. Radio's biggest Buying Guide—showing Everything in Radio at Lowest Prices! Also new and bigger Bargain Section—don't miss it!

AMATEURS! Don't miss the biggest Amateur Selection in all Radio! See all the new Ham Receivers, Transmitters and gear—also check the best Time Payment Plan offered anywhere. You'll see why ALLIED is famous as Amateur Headquarters!

RADIO BUILDERS! See the biggest Kit Section in Radio—dozens of brand-new Builders' Kits and diagrams—new ideas—new supplies and parts. There's nothing like this 1941 ALLIED Catalog in all Radio—get your FREE copy today!



ALLIED RADIO CORPORATION

833 W. JACKSON BOULEVARD
CHICAGO, ILLINOIS

FREE
SEND
COUPON

ALLIED RADIO CORP.
833 W. Jackson Blvd., Dept. 2-K-1
Chicago, Ill.

Send me your FREE 1941 Fall Radio Catalog showing Everything in Radio.

Name

Address

City State

A NEW BOOK ON PUBLIC ADDRESS

An important announcement about the greatest book on the subject of sound and allied subjects appears on the inside front cover of this issue.

TURN TO THE ANNOUNCEMENT NOW!



FILMGRAPH

VOICE AND MUSIC RECORDINGS

PERFECT SOUND on film recording can now be had with FILMGRAPH at only 25c per hour (this is cost of film only—no other expense). Permanent play-back. The only device capable of making lengthy recordings and play-back. Closing out several demonstrator models at special price. Complete 1940 line now ready

MILES REPRODUCER CO., INC., Dept. RC,
812 Broadway New York City



HIGH EFFICIENCY TRUMPETS

HIGH POWER Magn. DRIVE UNIT

HIGH POWER Reflex TRUMPETS

HIGH EFFICIENCY Day Loud SPEAKER

University

195 Chrystie St., N.Y.C.

RADIO OPERATORS' LICENSE GUIDE



Containing over twelve hundred and fifty acceptable answers to the new "Six Element" radio operator license examination questions as embodied in the Federal Communications Commission Study Guide.

YOU NEED THIS GUIDE TO PASS YOUR EXAMINATION

\$3.00 Postpaid, refunded if not satisfactory.

Wayne Miller, Suite 200 Engineering Building
222 North Wells Street, Chicago, Illinois.

NEW 5/8-VOLT TUBES!

The new miniature pentode voltage-amplifier tubes here illustrated and described affect a 3-fold saving; (1) dimensions are smaller, (2) the filament or "A" drain is less than half of that required by preceding types of miniature tubes, and (3) the plate or "B" current and voltage requirements have been lessened. These characteristics have special significance in the hearing-aid field; too, they will arouse the interest of technicians in other fields.

R. D. WASHBURNE



◀ The diminutive size of Raytheon's new types CK-505 (based) and CK-505X (unbased) hearing-aid tubes is emphasized in the photo at left. (Also see photo on cover.)

Right, as this family of curves illustrates, the 505-series miniature tubes are capable of excellent performance at a plate potential as low as 22.5 V. and with only 5/8-V. on the filaments.

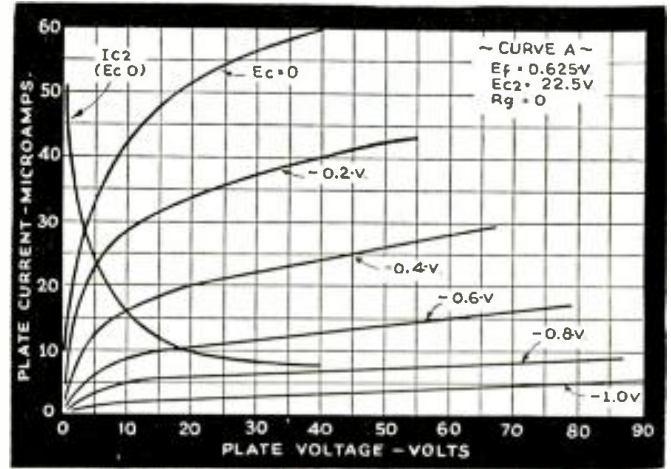

FURTHER impetus to the development of small-space equipment was the announcement by Raytheon Production Corp., last month, of miniature 5/8-volt-filament, pentode voltage-amplifier battery tubes smaller than anything previously described in *Radio-Craft*.*

These tubes require less than half the filament power of the present or 1.4-V. hearing-aid tubes and are a little shorter in size. In addition to hearing-aid application they may be used where extremely small size and low battery drain are the primary tube requirements.

MINIATURE A.F. AMPLIFIER

A pair of these tubes in a resistance-capacity-coupled amplifier afford a voltage gain of about 225 at a "B" voltage of 30 V. The total "B" drain for both tubes is 54

microamperes; the total "A" drain for these 2 tubes, with filaments in series, is 30 milliamperes at 1.25 V.

These 2 tubes, when used in this manner in a hearing-aid amplifier must be followed by an output stage which may include 1 of the previously available miniature tubes, designed to connect directly across the "A" supply. The tube actually used in the output stage will vary with individual requirements.

Thus if the amplifier is to drive a bone conductor somewhat greater output will be required than if the output device is to be an earphone, etc. This in turn will tend to determine the maximum voltage and current which the "B" supply will be called upon to deliver. These "B" voltage and current requirements in turn will determine the size of the "B" supply and hence the overall size of the completed apparatus.

The present tendency in miniature battery-type radio receivers is to design the

apparatus to operate from an ordinary dry-cell "A" supply and to replace this "A" cell several times from general stock before it becomes necessary to change the "B" battery. It is believed that the new 5/8-v. tubes will tend to emphasize this tendency in hearing-aids in which they may be incorporated.

The writer suggests that the audio amplifier here diagrammed may be incorporated as the A.F. section of a miniature radio receiver. However, experiments with a view to adapting these new 5/8-v. tubes to use in the R.F. portion of a radio receiver have not been completed, and to suggest that they may operate satisfactorily in a particular arrangement of R.F. circuits would be premature.

The CK-505 is equipped with a special miniature base. The CK-505X has tinned copper leads for direct soldering and is supplied with a removable standard base to facilitate re-testing. The electrical char-

*"Radically New Miniature Tubes," Feb. 1940; "4 Thumb-Size Pentodes for Hearing-Aids," May 1940.

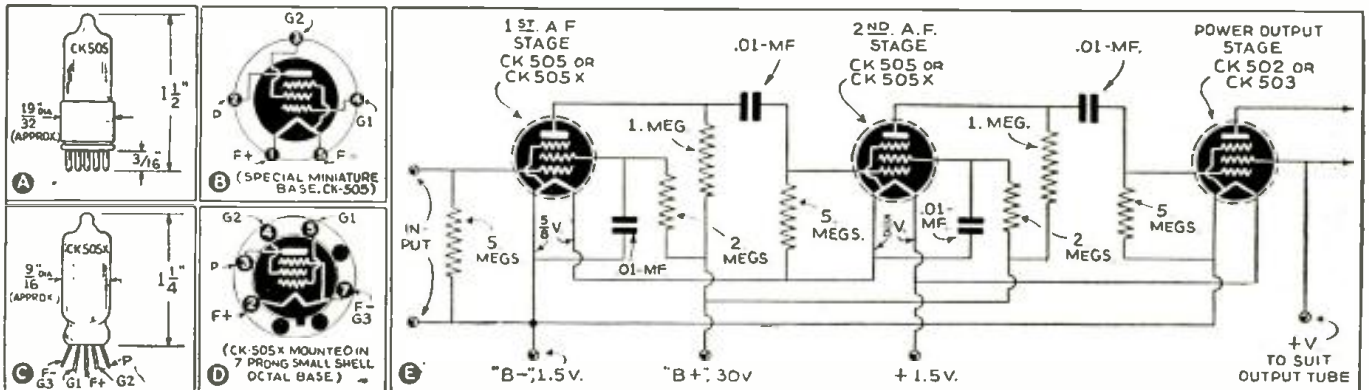

Details of Raytheon's new 5/8-v. miniature hearing-aid tubes; and, a fundamental audio amplifier circuit incorporating these tubes. A and B, dimensions of the CK-505, and terminal arrangement of its special 5-prong miniature base; C and D, dimensions of the unbased or CK-505X, and the arrangement of its terminal leads as viewed with the type number on near side. In E, note that 2 of the 5/8-v. tubes are not sufficient for a hearing-aid amplifier. The type of tubes selected for use in the 3rd stage will depend upon individual requirements as to output power. Some variation of the constants shown above may be required in individual instances to obtain adequate circuit stability as the "B" battery approaches the end of its life.

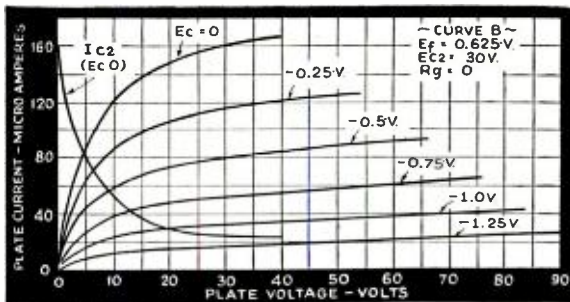

Average plate characteristics for the CK-505 and CK-505X with a plate potential of 30 V. and no grid bias.

Average plate characteristics for CK-505 and CK-505X with 45 V. on the plate and no grid bias.

NOTE—An important advantage in the use of tubes with filaments connected in series is that operation is obtained at lower "A" drains. This results in a larger proportion of "A" life than in reduction of "A" current drain.

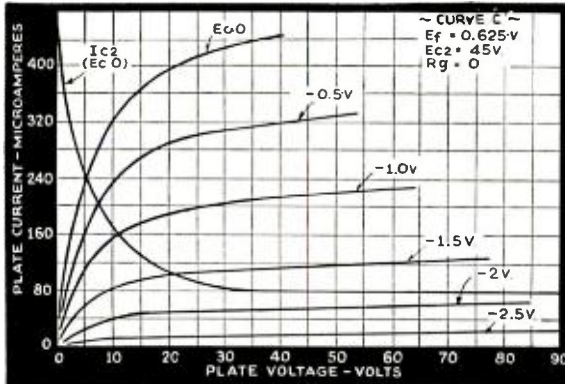

acteristics of these tubes are given in the tabulation.

TABLE I
Direct Interelectrode Capacities
(Approximate)

Grid to plate	0.25 mmf.
Input	2.5 mmf.
Output	3.5 mmf.
Ratings	
Max. fil. voltage (drycell supply)	
Voltage must never exceed	0.78 V.
Mean filament voltage	0.625 V.
Max. plate voltage	45 V.
Max. screen-grid voltage	45 V.

KEEP "TUNED" TO RADIO-CRAFT FOR NEW TUBES

Scan past issues of *Radio-Craft* and realize for yourself how thoroughly all new tubes were "covered"—almost as soon as they were announced by the manufacturers. This story on 5/8-volt tubes is another instance. Next month there will be still another story on additional new tubes.—Stay "tuned" to *Radio-Craft* for such and other vital data.

Typical Amplifier Operation—Class A

	Impedance	Coupled	Resistance	
	0.625 D.C.	0.625 D.C.	Coupled	0.625 D.C.
Filament voltage*	0.625 D.C.	0.625 D.C.	0.625 D.C.	V.
Filament current	0.030	0.030	0.030	A.
Plate voltage	30	45	30‡	V.
Screen-grid voltage	30	45	30‡	V.
Control-grid bias†	0	1.25	0	V.
Plate resistance (approx.)	1.1	2.0	—	megs.
Transconductance	140	150	—	micromhos
Plate current	0.17	0.2	.020	ma.
Screen-grid current	0.07	0.08	.007	ma.
Voltage amplification			15	—

*The filaments of 2 tubes may be operated in series directly from a single small flashlight cell. If larger cells are used or if other factors cause the mean battery voltage to exceed 1.25 volts computed over the normal battery life, a series filament resistor should be used to reduce the mean filament voltage to 1.25 volts for the 2 tubes in series.

†Grid circuit returned to negative filament. The D.C. resistance in the grid circuit should not be less than 5 megohms.

‡Supply Voltage. Plate resistor: 1 megohm. Screen-grid resistor: 2 megohms bypassed with 0.01-mf. Coupling Condenser: 0.01 mf.



**RADIO BRIDGES
10,000-MILE GAP**

"Tell me, how are you? Is it terribly cold down there?" asked Mrs. Harriet S. Eklund as she chatted over 10,000 miles of space by shortwave radio with her husband, Carl, assistant biologist with Admiral Byrd's U.S. Antarctic Expedition at East Base in the regions of the South Pole. It was the first time she had heard her husband's voice since last November. Her husband told her they were having a heat wave down there and that the temperature was 18 above zero—as against 70 below experienced just 2 weeks previous. Two-way conversations are a feature of the "short-wave mailbag" sent by radio every 2 weeks by General Electric to the Expedition.

More Than 25 Proved Sales Promotion Services Help You Sell



WHEN you stock Sylvania Radio Tubes, you get the most comprehensive and effective merchandising service that ever helped a dealer to bigger profits.

Look over the partial list below. Many are free. Others are available at satisfying savings. All help you sell.

Write Hygrade Sylvania Corp., Dept. RC100, Emporium, Pa., for samples of these selling aids and full information about the Sylvania way to bigger profits.

Sylvania Helps . . . That Help You Sell

- Big store displays
- Window displays
- Counter displays
- Electric Clock Signs
- Electric Window signs
- Outdoor metal signs
- Window cards
- Counter cards
- Personalized post-al cards
- Imprinted match books
- Imprinted tube stickers
- Business cards
- Do or Knob Hangers
- Newspaper mats
- Store stationery
- Bill heads
- Service hints book-lets
- Technical manual
- Tube base charts
- Price cards
- Sylvania News
- Characteristics Sheets
- Interchangeable tube charts
- Tube complement books
- Folding stock boy cabinets
- Floor model cabinet
- Large and small service carrying kits
- Customer card index files
- Shop coats
- 3-in-1 business forms
- Job record cards (with customer receipt)

SYLVANIA

SET-TESTED RADIO TUBES

Also makers of Hygrade Lamp Bulbs and Miralume Fluorescent Light Fixtures

LOUDSPEAKER VIOLINS

AND HOW THEY WORK

The following article analyzes the pros and cons of amplifying to concert volume, and reproducing at this high level, the tones of a single violin as compared to the use of many unamplified violins. Not since the 16th Century have any fundamental changes been made in the construction of the violin. Now, however, the author here describes how a Master Electronic Violin may be made, and how it may be used to drive any number of easily-built Loudspeaker Violins; the ensemble constitutes a "Super-Violin."

R. VERMEULEN

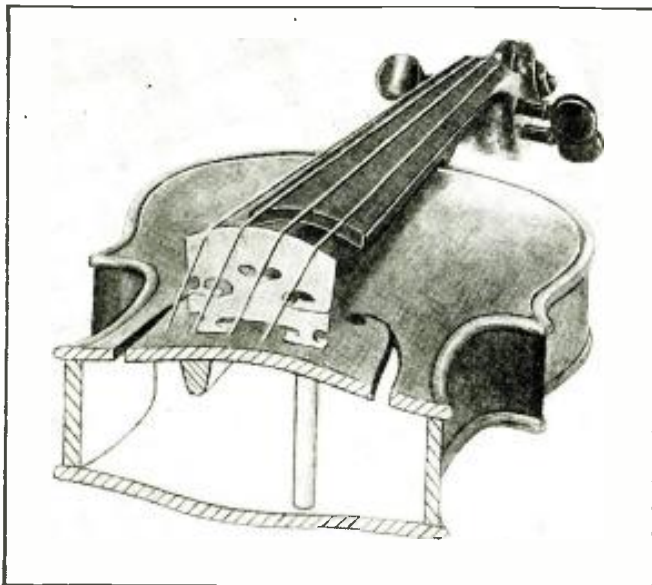

Fig. A. Cross-section through a violin at the position of the bridge. To the right (under the E-string) the sound post, to the left (under the G-string) the bass bar. The strings vibrate chiefly in a horizontal direction.

EDITORIAL FOREWORD. *Is it sufficient merely to attach to a violin a contact microphone, and then feed its amplified output to loudspeakers, instead of using a large number of violins in order to secure concert volume? If so, where on such a Master Electronic Violin is the best place to put the contact mike? Further, can an ordinary violin be used to any advantage, in place of the usual loudspeakers, as a Loudspeaker Violin? If so, should the strings be removed; and where should the driving unit be placed? To these and many other interesting questions on this subject, the author gives definite, laboratory-tested answers. The story is Philips Glowlampworks's (Eindhoven, Holland) valuable contribution to Electronic Music.*

THE march of Time has brought with it the need for a "super violin"—one in which existing tonal qualities are retained but at volumes heretofore unattainable—and modern radio means have shown how such an instrument may be had. First, however, let us turn back the calendar 400 years.

THE 16TH CENTURY VIOLIN

During the 16th Century—since which time no further fundamental changes in the construction of the violin have occurred—the violin was used chiefly for chamber music and for musical programs in the reverberating spaces of churches.

Contrast this situation with that of today in which the violin must be played in concert halls often of enormous size, and before huge audiences.

This demand for greater instrument volume has been reflected in increasingly large orchestras where a number of instruments of one type may play a given portion of the score in unison; as many as 25 violins, for example, may play a single bar of music simultaneously.

Increasing the intensity by thus multiplying the number of musicians presents no difficulty where only average skill in playing in collaboration is required; instead, the real problem arises when talented musicians play solo, with orchestral accompaniment.

Under this condition, the soloist may find it extremely difficult to maintain the intensity of his single instrument at a level sufficiently high above the sound-level of the accompanying instruments, even though the conductor may make every effort to hold the orchestral accompaniment in check.

There is not only the danger that the artist will be distracted by the exertion from complete surrender to the music he is interpreting, but moreover the quality of the tone may suffer because of the fact that non-linear distortion may occur with too-great amplitudes of the strings and sounding boards, and result in squeaking and scratching. Every violin soloist will acknowledge the fact that it would be an improvement very much to be appreciated if it were possible to increase the volume of sound from the violin while retaining its other qualities.

How could this be done? It is known from experience that the instruments of the famous 18th Century violin builders Stradivarius and Guarnerius, not only possess a more beautiful tone, but that they produce a greater intensity with much less effort! The knowledge of the methods used to obtain these qualities seems to have been lost, so that until now we have been unable to equal these old violins.

Some people even believe that efforts in this direction are doomed to failure because the old violins owe their fine quality to the fact that they are so old and have been played for so long a time by so many excellent violinists. Aside from this, however, the desired effect could not be achieved even if it were possible to copy the old violins exactly, since even a Stradivarius does not produce enough volume to come out above the accompaniment of a large orchestra.

LARGER VIOLIN—GREATER VOLUME?

A second possibility of amplifying the sound of the instrument would be to increase its dimensions. As was explained some time ago in one periodical in connection with the simplest sound radiator, the pulsating sphere⁽¹⁾, the acoustic power produced increases with the size of the radiator. In our case, however, this method cannot be

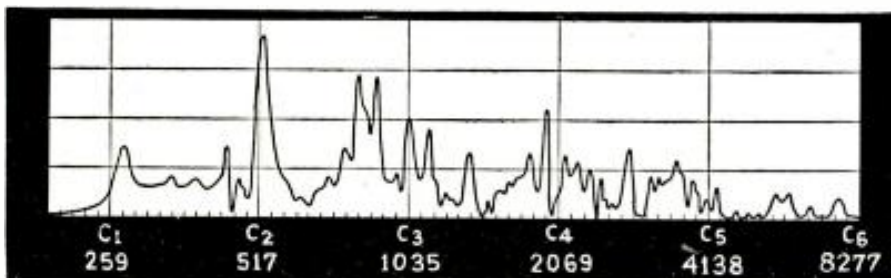

Fig. 1. Frequency characteristics of an average violin. The violin's body resonances produce harmonics which determine its identifying timbre. (From H. Meinel, *Akust. Z* 4, 89, 1939.) (Note how these resonances at various points across the frequency spectrum result in emphasizing the uniform test frequency; and therefore, will introduce the same emphasis into any frequencies which the violin may produce when its strings are bowed.—Editor)

(1) A. Th. van Irk and R. Vermeulen, "Radiation of Sound," *Philips Techn. Rev.* 4, 213, 1939.

considered for obvious reasons: the size of a violin determines to a large extent its timbre. If we make it larger we do not obtain a louder violin, but a viola or a cello.

A solution of this difficulty may be sought by making use of modern electro-acoustic aids. The sound of a violin can be picked up with a microphone, the microphone voltage amplified at will and fed to a loudspeaker.

But the question now arises: where must we place the microphone? It would be most reasonable to pick up the sound of the violin at the position of the hearers. If we do this, however, we are no further ahead, since the sound of the orchestra is then amplified together with the violin solo.

In order to shift the ratio of the two sound contributions in favor of the solo instrument the microphone would therefore have to be hung in the immediate neighborhood of that instrument. Such a solution is employed for example in an analogous case in which a singer's voice must be clearly heard above a jazz band. Placing the microphone close to the source of sound, however, has the objection that the sound may differ considerably in timbre from that at a greater distance. In the example mentioned of the jazz singer this fact has led to the development of a special singing technique known as "crooning." The violin is, however, much larger than the mouth opening of a jazz singer, and moreover, the violinist needs a certain freedom of movement, so that the placing of the microphone close to the solo violin cannot be considered.

These difficulties are avoided if, instead of the acoustic vibrations around the violin, the mechanical vibrations of the body of the violin are picked up⁽²⁾ with the help of a kind of electrical phono pickup, and then amplified. The practical realization of this principle, which has been tested in the Philips Laboratory, involves several other considerations which we shall discuss briefly.

THE SOURCE OF VIOLIN "TONE"

When the bow slides over a string a relaxation vibration sets in, in which the deviation of the string varies as a function of the time approximately according to a saw-tooth relation. This vibration of the string, which is composed of a large number of harmonics, is communicated *via* the bridge to the body of the violin, which then in turn begins to vibrate and radiates the vibrations in the form of sound.

By the very pronounced resonances of the body of the violin (see the frequency characteristic, Fig. 1) harmonics in certain regions are amplified and the typical violin quality is obtained; the body of the violin thus determines the instrument's characteristic tone or *timbre*. To each of the resonances mentioned there corresponds a certain form of vibration of the body of the violin which could be made visible by (Chladni sound figures.

From this it follows, however, that it is impossible to use the mechanical vibrations of the body of the violin itself for the purpose in view. If one should set the needle of a vibration pick-up at any point on the sounding board for a given frequency, this point might just lie at a node of the vibration occurring, so that this frequency would not be communicated. *The only spot on the whole violin where all the vibrations will certainly be encountered is the bridge, which passes the vibrations of the strings on to the sounding board.*

On the other hand we have just seen that the vibrations of the bridge can by no means

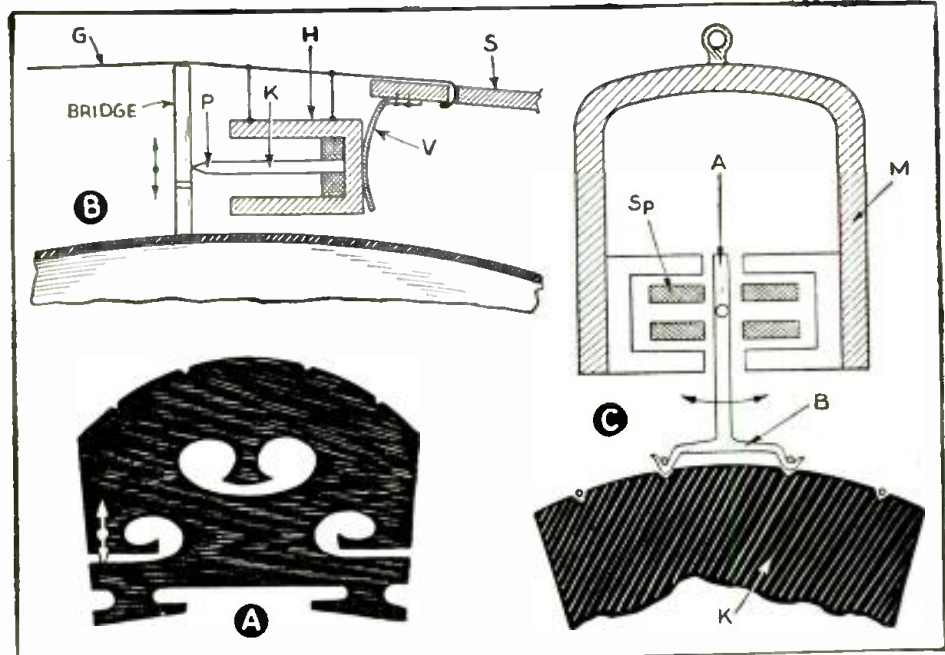

Fig. 2. Details of the Master Electronic and the Loudspeaker Violins. A, typical violin bridge. In the Master Electronic Violin the vibration pick-up placed on the circle at left moves in the direction of the arrow. B, how voltage is generated in the crystal contact mike (vibration pick-up). C, method of driving the Loudspeaker Violin.

represent the sound of the violin, since they have not yet passed through the timbre-determining organ. If therefore we should reproduce the vibrations of only the *bridge* by means of an ordinary loudspeaker, the sound so obtained would not resemble the sound of a violin.

In this way we arrive at the remarkable conclusion that in reproducing the vibrations we must still include the organ which determines the timbre, namely by using a violin body as loudspeaker. *The vibrations which are picked up from the bridge of the solo violin are communicated to the bridge of a second violin which then in principle radiates the same sound as if it were made to vibrate by the vibrations of the strings of the first violin (3).*

"MASTER ELECTRONIC VIOLIN"

In picking up the vibrations it is not a matter of indifference what spot on the bridge is chosen. Figure A shows a cross-section of a violin through the bridge. Under the right-hand end of the bridge, *i.e.*, under the E-string, there is a vertical wooden peg between the belly and the back of the violin, the so-called *sound post*. The amplitude of the belly at this point is therefore practically zero, and we may say that the bridge can only execute a rotating motion about its right-hand point of support. The rotating motion of the bridge is caused by the strings vibrating mainly in a horizontal direction. By the left-hand point of support the belly of the violin is then brought into transverse vibration. In order to spread this vibrating motion over a larger surface the sounding board at this point (under the G-string) is reinforced by a thicker oblong piece of wood, the so-called *bass bar*.

As point of contact for the point of the vibration pick-up with which we wish to pick up and then amplify the sound of the violin, we choose the spot on the bridge indicated by a circle, Fig. 2A, since we can expect to find the greatest amplitudes here; that is, the bridge executes chiefly a rotating motion around its right-hand point

of support, and, therefore, the greatest amplitudes occur on the left. The point then moves in the direction of the arrow (perpendicular to the sounding board).

Figure 2B shows the method of attaching the vibration pick-up. (Crystal element K in elastic holder II bends in the direction of the arrow when its contact point P is moved vertically by the bridge; holder II, suspended on the "dead end" of G-string G, is

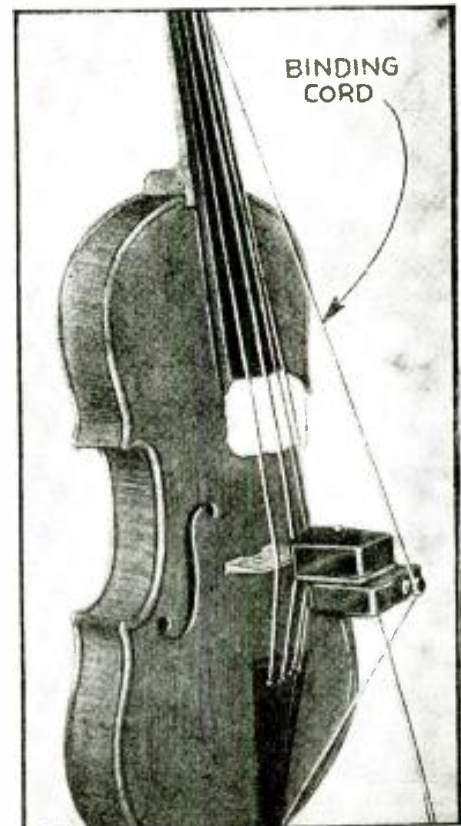
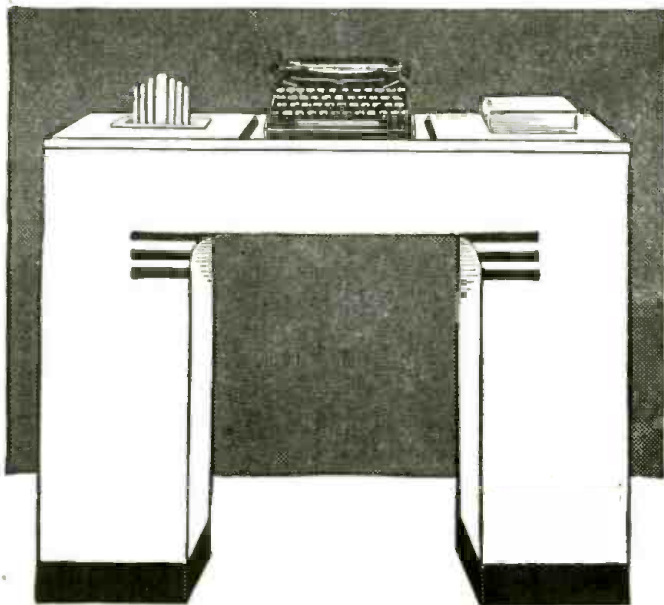

Fig. 3. Closeup of the Loudspeaker Violin. Any number of these may be used; they may be hung on strings in an orchestra and then driven, through an amplifier, by a single Master Electronic Violin. Note the wad of cotton wedged under the strings, at the end of the fingerboard, to damp vibration of the strings.

(2) Similar considerations have already been discussed in the description of a "Laryngophone" which makes telephone communication possible in places where there is much noise: Philips Techn. Rev. 4, 6, 1940.

(3) When loud-speaker technology was still in its infancy, a violin or mandolin body was sometimes used as loud-speaker. This was done, however, to amplify the normal sound of speech or music. The fact that this was a mistaken idea is clear after the above.



**THIS
BEAUTIFUL DESK
for only \$1.00 EXTRA**

**WITH ANY
REMINGTON
PORTABLE TYPEWRITER**

The
COMBINATION
FOR AS LITTLE AS
10¢ A DAY

How easy it is to pay for this combination of desk and Remington Deluxe Noiseless Portable Typewriter! Just imagine, a small good will deposit with terms as low as 10¢ a day to get this combination at once! You will never miss 10¢ a day. Yet this small sum can actually make you immediately the possessor of this amazing office at home combination. You assume no obligations by sending the coupon.

A beautiful desk in a neutral blue-green which will fit into the decorations of any home—trimmed in black and silver—and made of sturdy fibre board—is now available for only one dollar (\$1.00 extra) to purchasers of a Remington Noiseless Portable Typewriter. The desk is so light that it can be moved anywhere without trouble—it is so strong that it will hold six hundred (600) pounds. With this combination of desk and Noiseless Deluxe Portable Typewriter, you will have a miniature office at home. Learn the complete details of this offer. Mail the coupon today.

THESE TWO EXTRA FOR YOU

LEARN TYPING FREE

To help you even further, you get free with this special offer a 32-page booklet, prepared by experts, to teach you quickly how to typewrite by the touch method. When you buy a Noiseless you get this free Remington Rand gift that increases the pleasure of using your Remington Noiseless Deluxe Portable. Remember, the touch typing book is sent free while this offer holds.



SPECIAL CARRYING CASE

The Remington Deluxe Noiseless Portable is light in weight, easily carried about. With this offer Remington supplies a sturdy, beautiful carrying case which rivals in beauty and utility the most attractive luggage you can buy.



SPECIFICATIONS

ALL ESSENTIAL FEATURES of large standard office machines appear in the Noiseless Portable—standard 4-row keyboard; back spacer; margin stops and margin release; double shift key and shift lock; two color ribbon and automatic ribbon reverse; variable line spacer; paper fingers; makes as many as seven carbons; takes paper 9.5" wide; writes lines 8.2" wide. There are also extra features like the card writing attachment, black key cards and white letters, touch regulator, rubber cushioned feet. These make typing on a Remington Deluxe Noiseless Portable a distinct pleasure. Thousands of families now using the Remington Deluxe Noiseless Portable know from experience how wonderful it is!



**MAIL
COUPON
NOW!**

Remington Rand Inc., Dept. 189-10
465 Washington St., Buffalo, N. Y.

Tell me, without obligation, how to get a Free Trial of a new Remington Deluxe Noiseless Portable, including Carrying Case and Free 32-page Typing Instruction Booklet on terms as low as 10¢ a day. Send Catalogue.

Name.....
Address.....
City..... State.....

OPPORTUNITY AD-LETS

Advertisements in this section cost 15 cents a word for each insertion. Name, address and initials must be included at the above rate. Cash should accompany all classified advertisements unless placed by an accredited advertising agency. No advertisement for less than one week is accepted. Ten percent discount for six issues, twenty percent for twelve issues. Objectionable or misleading advertisements not accepted. Advertisements for November, 1940, issue must reach us not later than September 7th.

Radio-Craft • 20 Vesey St. • New York, N. Y.

AGENTS WANTED

300% PROFIT SELLING GOLD LEAF LETTERS FOR store windows: Free samples. Metallic Company, 451 North Clark, Chicago.

BOOKS AND MAGAZINES

ASSURE YOURSELF OF GREATER PROFITS BY doing radio service jobs more quickly. Authentic service guides show you the way to locate and correct troubles in any radio receiver. Gernsback Official Radio Service Manuals show you how to complete more repair jobs in less time—how to earn more money faster servicing. Read the advertisement which appears on page 198 of this issue.

WE HAVE A FEW HUNDRED RADIO ENCYCLO-pedias, by S. Gerstback, second edition, originally sold at \$3.98. Book has 372 pages, weight 3 lbs., size 9 x 12 inches. Red morocco—keratol flexible binding. Send \$2.49 in stamps, cash or money order and book will be forwarded express collect. Technifax, 1915 So. State Street, Chicago, Illinois.

BUSINESS OPPORTUNITIES

AMBITIOUS? EXTRA MONEY SHOWING TALKIES—home or neighboring towns—no investment—sound equipment, films rented reasonably \$100-\$300 monthly possible—wonderful opportunity. 512 State Theatre Building, Pittsburgh, Pennsylvania.

DIATHERMY MACHINES

DIATHERMY, SHORT-WAVE THERAPY, AND ULTRA short-wave therapy machines custom-built by radio engineer at considerable saving over commercial machines; 6 meters, 16 meters or any other frequency specified can be furnished. Machines substantially built with high patient safety factor. 250-300 watts output. Neat professional appearance. Automatic safety time switches. All necessary pads and electrodes. For sale only to physicians, hospitals, and sanatoriums. Prices from \$195.00 to \$300.00. Not for sale to the general public. Write, giving your own specifications and requirements. No literature available; custom construction only. Allan Stuart, P. O. Box 56, Teaneck, N. J.

EDUCATIONAL COURSES

USED CORRESPONDENCE COURSES AND SERVICE Books Bought, Sold or Rented, Catalog Free. Vernon Exchange, Henagar, Alabama.

CORRESPONDENCE COURSES AND EDUCATIONAL books, slightly used. Sold, Rented, Exchanged. All subjects. Satisfaction guaranteed. Cash paid for used courses. Complete details and bargain catalog FREE. Write Nelson Company, 500 Sherman, Dept. K-242, Chicago.

INSTRUCTION

SPECIALIZE! AUTO RADIO NOISE EXPERTS MAKE 75c-\$1.50 hourly. Compact, complete, workable treatise \$1.00. Particulars free. Jenkins, 392R, Elmira, N. Y.

MANUSCRIPTS WANTED

WANTED—MANUSCRIPTS, POEMS, SONGS FOR publication. Fortuny's, 87 Fifth Ave., New York.

ORE LOCATORS

RADIO TREASURE FINDERS. "FISHER" METAL- scopes, brand New, Cheap. Kenneth Marshall, Belmont, Mississippi.

PHOTOGRAPHY

1/100,000 OF A SECOND SPEED FLASH UNIT FOR Stroboscopic Photography, \$200.00. Apt. 63, 782 West End Ave., New York City.

RADIO

WE BUY AND SELL USED RADIO TESTING EQUIP-ment. Time payments if desired. Harold Davis, Inc., Jackson, Miss.

WILL SWAP TEST EQUIPMENT, CAR-RADIO SET, radio books, experimental receivers, camera—or what do you want—for magnetic detector airplane-cloth speaker, Adams-Morgan wood-case variable condenser, navy-type loosecoupler, deForest Audion control box, W.E. 18-inch magnetic cone speaker, or what old apparatus have you? H. Bernard, 40 Manning Ave., N. Plainfield, N. J.

HARD-TO-GET RADIO DIAGRAMS, TRY USUAL sources first. If you can't get them, try us. Price, 75c to \$1.50 if we succeed; no charge if we don't. You lose nothing! Send no money—write first giving fullest information. Enclose return-addressed, stamped envelope. We have helped many Servicemen, experimenters and radio fans. We may help you. Allan Stuart, P.O. Box 56, Teaneck, N. J.

STAMPS

THREE SCARCE SETS, NOW OBSOLETE, 25c. WITH new customer. Gift: Box 211, Malden, Mass.

TECHNICAL ART SERVICE

DRAFTING AND ART SERVICE—A COMPLETE Service for the Industrial and Commercial Marketers. If your business or plant can't afford a designing or drafting staff, don't let this stop you from going ahead with that new product, you intend marketing, or that catalog of mechanical or electrical items which needs fine detailed drawings and highly retouched photographs. Any mechanical, electrical or radio problem can be solved for you by our associated staff of designers, draftsmen and artists, and technical copywriters. Write for any additional information as to methods and price for this service. Tec-Art Drafting Service, 228 Charlotte Terrace, Roselle Park, N. J.

DRAFTING SCHEMATIC DIAGRAMS SEND US A rough sketch of your circuit. Estimates by return mail. Our prices are moderate; our work guaranteed. No job too big or small. Wm. Kadlecik, Jr., 440 East 85th St., New York, N. Y.

pressed against the bridge by spring V attached to the violin's tailpiece S. (Leads to the input of the power amplifier are not shown.)

"LOUDSPEAKER VIOLIN"

The excitation of the bridge of the "Loudspeaker Violin" is by means of an apparatus similar to that used for the recording of phonograph records(*). In order to apply the principle entirely consistently the excitation should take place at the spot on the bridge corresponding to that at which the vibrations were picked up on the solo violin. In practice this was not found possible since the spot indicated in Figure 2A is not suitable for the firm attachment of the recorder to the bridge, which is necessary because of the fairly large forces to be communicated.

As shown in Figure 2C, the motor unit was therefore fastened to the top of the bridge by means of a bent strip of metal clamped under the 2 middle strings. Motion of armature A in the plane of the bridge K, excites a voltage in speaker coils SP. (Leads to the output of the power amplifier are not shown.) The heavy mass of the magnet M and the pole-pieces, supported by a cord bound to the extremities of the violin, by inertia remain practically at rest (see Figure B).

Or put another way, when in use the strip of metal which moves with the vibrating armature of the recorder tends to execute a tipping motion whereby a couple is exerted on the bridge in the same direction as by the original movement of the strings. This arrangement was found to be very satisfactory.

The strings themselves on the Loudspeaker Violin may not of course take part in the vibration, since they are not continually being tuned to the correct pitch by stopping. The motion of the strings is therefore entirely damped by means of a wad of cotton. *The strings cannot be omitted!* The reason is that by the tension which they communicate to the body of the violin, they affect fundamentally the properties of the latter in its function as the organ which determines the timbre(5).

AMPLIFICATION

The amplification which can be obtained by means of such a Loudspeaker Violin is of course limited by the above-mentioned non-linear distortion which becomes noticeable at too-great amplitudes of the components of the violin. If it is desired to increase the amplification still further, as many more Loudspeaker Violins as desired must be connected in parallel.

Let us return for a moment from the laboratory to the concert hall. When the above-described method of amplification is applied, the sound of the solo violin is reproduced by 5 or 10 loudspeaking violins at the same time. This raises the question of whether this method might not make it possible to dispense with a large number of musicians in the orchestra. Instead of 25 1st violins, could one use a single violinist, and allow 24 other violins to amplify his performance? If the multiple performance of every violin voice had as its only aim an increase in the intensity, this conclusion would in fact be justified. Actually, however, the situation is much more complicated. From the point of view of the composer,

(* K. de Boer and A. Th. van Urk, "A Simple Apparatus for Sound Recording," Philips Techn. Rev. 4, 106, 1939.

(5) The variation in the tension due to the varied stopping during playing is in this respect a second-order effect which may be neglected.

This article has been reprinted by special permission of Philips Glowlampworks, Ltd., Eindhoven, Holland, publishers of the magazine in which it originally appeared. (The publishers of Philips Technical Review are represented in the United States by Philips Technical Products, Inc., New York, N. Y.)

Now a—high-powered—



New

The Library now comprises a revised selection of books culled from latest McGraw-Hill publications in the radio field.

Radio Engineering Library

—especially selected by radio specialists of McGraw-Hill publications
—to give most complete, dependable coverage of facts needed by all whose fields are grounded on radio fundamentals
—available at a special price and terms

These books cover circuit phenomena, tube theory, networks, measurements, and other subjects—give specialized treatment of all fields of practical design and application. They are books of recognized position in the literature—books you will refer to and be referred to often. If you are a practical designer, researcher or engineer in any field based on radio, you want these books for the help they give in hundreds of problems throughout the whole field of radio engineering.

5 volumes 3319 pages, 2298 illustrations

1. Eastman's FUNDAMENTALS OF VACUUM TUBES
2. Terman's RADIO ENGINEERING
3. Everitt's COMMUNICATION ENGINEERING
4. Hund's HIGH-FREQUENCY MEASUREMENTS
5. Henney's RADIO ENGINEERING HANDBOOK

10 days' examination. Special price. Monthly payments. These valuable books cost you only \$25.50 under this offer. Add these standard works to your library now; pay small monthly installments, while you use the books.

SEND THIS ON-APPROVAL COUPON

McGraw-Hill Book Co., Inc.
330 W. 42nd St., New York, N. Y.

Send me Radio Engineering Library, 5 vols., for 10 days' examination on approval. In 10 days I will send \$2.50, plus few cents postage, and \$3.00 monthly till \$23.50 is paid, or return books postpaid. (We pay postage on orders accompanied by remittance of first installment.)

Name

Address

City and State

Position

Company RC-10-40

without doubt the *choral effect* of the multiple representation of each voice also plays an important part. This effect is obtained by (1) the slightly differing moment of attack, by (2) the small differences in pitch and in the vibrato, as well as by (3) somewhat differing timbres of the violins and (4) the scattering of the sources of sound over a larger area. The first 2 of these 4 factors would be lost if we substituted for the 24 violinists simply 24 Loudspeaker Violins. It is quite possible that this would be a serious objection. Experience alone can decide the question.

The consideration of the choral effect also however has consequences in the application of the method to the solo violin. The 2 last mentioned factors (3) and (4)—differences in timbre and scattering of the radiating surface, respectively—now enter as additional factors in the case of the solo violin, and it is not impossible that the impressions received by the listener will be appreciably altered thereby. Whether the change is permissible, or whether it may even be an improvement, these are questions which cannot be answered by means of laboratory experiments.

SERVICEMEN

Keep posted on F.M. It's the coming thing. See page 204 and past issues of Radio-Craft for servicing data.

★ ★ ★ **THREE STAR RADIO VALUE**

You receive valuable subscription to **RADIO-CRAFT**
PLUS A FREE COPY of 1940 Radio-Television Reference Annual

WITH our compliments, we want to send a copy of the 1940 RADIO-TELEVISION REFERENCE ANNUAL to you FREE, if you will simply take advantage of RADIO-CRAFT magazine's special subscription offer NOW. This offer is being made for a limited time only.

The 1940 RADIO-TELEVISION REFERENCE ANNUAL has 68 pages, large size 8½ x 11½, with over 170 illustrations. The contents of this book has never appeared before in handy book form. Its pages cover practically every branch of radio sound, public address, servicing, television, construction articles for advanced radio men and technicians, time and money-saving kinks, wrinkles, useful circuit information, "ham" transmitters and receivers, and a host of other data.

The Annuals have always been regarded as a standard reference work for every practical branch of radio operation and service. This 1940 edition ably sustains this reputation. Every radio man wants a copy of this valuable book. Just as this book will be of unquestionable value to you, so, too, will every monthly issue of RADIO-CRAFT. This magazine brings you big value every month. It keeps you intelligently informed about new developments in radio and television. You want the news, want it fully but concisely, want it first—that is why you should read RADIO-CRAFT regularly.

This very special offer is made for just one purpose—we want you as a regular subscriber. The Annual, whose contents appears at the right, is not sold, but a copy is FREE to you if you subscribe now.

**SAME SIZE AS
 RADIO-CRAFT**

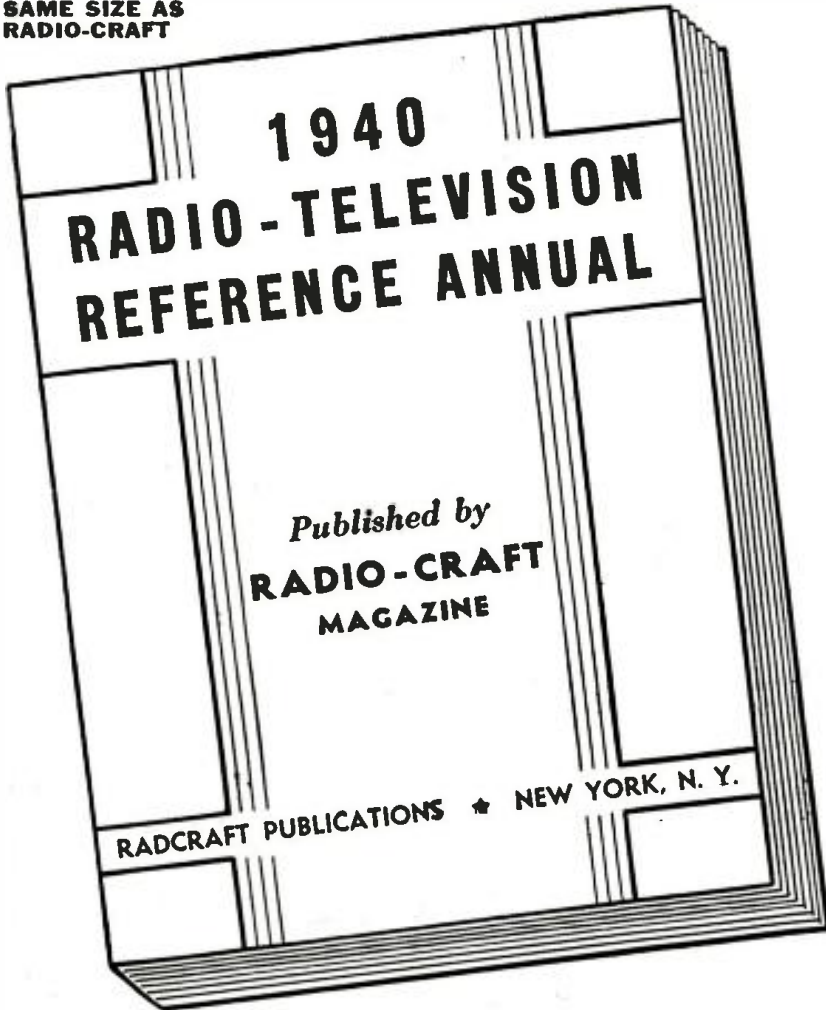

THIS COUPON BRINGS YOU THE ANNUAL

RADIO-CRAFT • 20 VESEY STREET • NEW YORK, N. Y.

Gentlemen: Enclosed you will find One Dollar for which enter my subscription to RADIO-CRAFT Magazine for Eight Months. Send me ABSOLUTELY FREE and POSTPAID, my copy of 1940 RADIO-TELEVISION REFERENCE ANNUAL.

This is a new order Extend My Present Subscription

NAME ADDRESS

CITY STATE

DON'T DELAY — MAIL TODAY! RC-1040

**Read the summary of contents
 in this FREE BOOK!**

THE 1940 RADIO-TELEVISION REFERENCE ANNUAL contains a collection of the best and most important articles. Covering as they do nearly every branch of radio, they form a handy reference works. In addition, many time and labor-saving kinks, circuits and wrinkles, tried and tested by practicing Servicemen, experimenters and radio fans have been included. This book cannot be bought anywhere at any price. Yet it is yours by merely subscribing. Use the convenient coupon below.

**BEGINNER'S SIMPLE INEXPENSIVE
 CONSTRUCTION ARTICLES**

Beginner's Breadboard Special - a 1-Tube High-Gain All-Wave Receiver—Wiring Pointers for Radio Beginners—A Watch Charm Size 1-Tube Set—Beginner's Simple Volt-Milliammeter—Making a 1-Tube Broadcast Loop Receiver—A.C.-D.C. Power Supply for Battery Portables—A 1-Tube Short-Waver with Band Coil Switching.

MORE ADVANCED SET CONSTRUCTION

The "High-Seas 4" Broadcast Lamp Radio—How to Build a 6-Tube 1.4-Volt Short-Wave Superhet for the "Ham" or Short-Wave Fan—Build the "Lunch Box 5" Super Set - a Broadcast Battery Portable—How to Build a Plug-Together 8 Tube Broadcast Set—The "5-in-1" All-Wave Radio for A.C. Operation—An Easily-Built 3-Tube Midget Broadcast Superheterodyne Receiver.

THE SERVICEMEN'S SECTION

Bass Tone Control—Simplified Variable Selectivity—Practical Servicing Pointers—Servicing Universal A.C.-D.C. Receivers—Killing the "Intermittent" Bug—A Service Shop A.C. to D.C. Power Supply—Sideline Money for Servicemen—Adding A.V.C. to any Screen-Grid T.R.F. Receiver—Iron Particles in Speaker Air Gap.

TEST INSTRUMENTS

A Useful Neon Lamp Tester—An Inexpensive Output Meter—Making Milliammeter Multipliers—Home-Made Frequency Modulator—The Busy Servicemen's V.T. Volt-Meter.

PUBLIC ADDRESS AND AMPLIFIERS

Build this Combination A.C.-D.C. Radio and Inter-Communicator—Speaker Placement in P.A. Work—The Design and Construction of an Inexpensive All-Push-Pull 10-Watt Amplifier—Obscure Sources of Hum in High-Gain Amplifiers—How to Build a High-Fidelity 5-Watt Versatile Amplifier.

"HAM" SECTION

Ultra-High Frequency Antennas—The Beginner's Low-Cost Xmitter—Modulator Meter—Phone Monitor—The Beginner's "Ham" Receiver—2½ Meter Acorn Transceiver.

TELEVISION

How to Build a 441 Line T.R.F. Television Receiver—Useful Notes on Television Antennas.

MISCELLANEOUS

Simple Photo-Cell Relay Set Up—Making a Burglar Alarm—How to Build A.C.-D.C. Capacity Relay—How to Make a Modern Radio Treasure Locator.

USEFUL KINKS, CIRCUITS AND WRINKLES

Making a Flexible Coupler—Two-Timing Chime—A Simple Portable Aerial—An Improvised Non-Slip Screw-Driver. NOTE: The book contains numerous other useful Kinks, Circuits and Wrinkles, not listed here.

(approximately)

45 ARTICLES

(approximately)

170 ILLUSTRATIONS

68 BIG PAGES

**RADIO-CRAFT
 20 VESEY STREET
 NEW YORK, N. Y.**

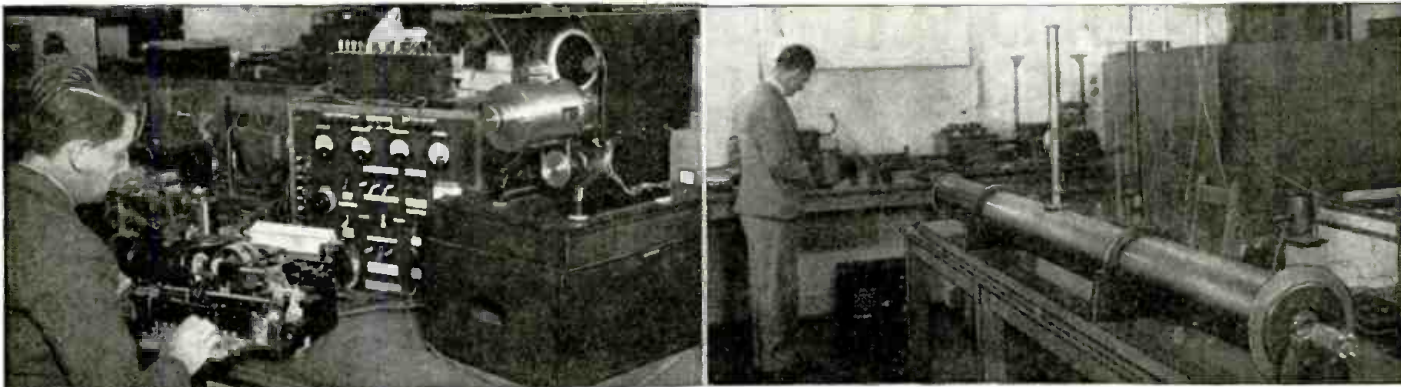

Views of 2 rooms in the G.P.O.'s Dollis Hill Laboratory. Left, telegraph laboratory; right, acoustic room showing Rayleigh tube.

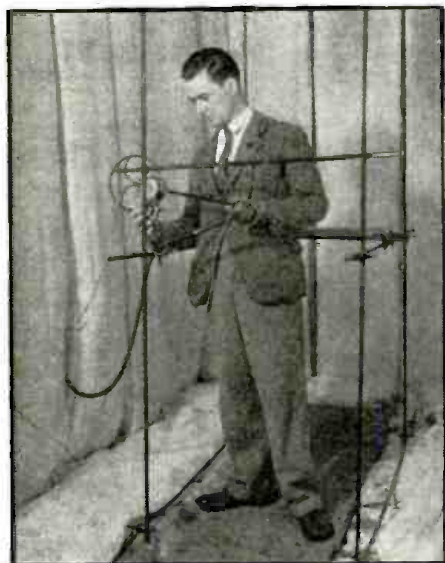

Microphone testing room. (See photo on cover.)

BRITISH G.P.O. TEST LABORATORY

In Northwest London is the Research Station of England's G.P.O.; otherwise known as the Post Office Engineering Department, here every scientific activity of this organization finds specialized laboratory facilities available.

IN order to keep government agencies informed of progress in the various technical fields associated with its activities, England's Government Post Office has established at Dollis Hill in Northwest London a research station of the Post Office Engineering Department. Here in well-equipped laboratories experts study every phase of its many fields of activities and analyze new equipment and procedures.

Transmitters, receivers, facsimile, television, wirephoto, and the equipment and procedures peculiar to many other fields daily receive attention. The photos here reproduced illustrate only a small portion of the activities of this scientific group.

Outside grounds afford an opportunity to test all manner of equipment, in Construction Park, under outdoor field conditions.

One of the buildings, comprising the Research Station, is a Mechanical Laboratory where equipment performance is analyzed. In an Acoustical Laboratory, microphones, loudspeakers, and other sound equipment are tested. Here too the sound track discs used in the speaking clock which gives Londoners the correct time receive microscopic examination, and noise meters analyze every source of mechanical and electrical noise.

In the Radio and Electrical Laboratory circuits and components are tested.

AUTOMATIC RADIO WEATHER ROBOT

An earth-bound mechanical cousin to the high-flying balloon-radiosonde illustrated and described in past issues of Radio-Craft is now in use at the U.S. Naval Air Station at Anacostia, D. C. The manner in which this new weather robot operates is concisely described in the following article.

AUTOMATIC weather observing stations, untouched by human hands for months at a time, may soon be scattered around on high mountain peaks or at inaccessible sea locations so that Uncle Sam's weathermen can have complete and automatic radio reports on the changing weather, necessary for predictions.

A radio weather robot, developed by two National Bureau of Standards radio engineers, Harry Diamond and Wilbur S. Hinman, Jr., with the cooperation of the Naval Bureau of Aeronautics, has undergone a successful 2-months' test at Naval Air Station at Anacostia near here.

Radio messages that it sends out at predetermined intervals tell the barometric pressure, air temperature, relative humidity, wind direction and velocity, rainfall and other meteorological factors.

A mechanical cousin to the high-flying radio sondes now extensively sent aloft by means of unmanned balloons for upper-air weather information, the new robot weather station is designed for stationary installations. It is actually simpler than the radio sonde type of weather-observing machine.

By operating on a relatively low frequency, signals from the automatic weather

station can be received with any standard receiver. Even through severe static interference, it will only be necessary for the operator, with stop watch, to listen-in and count the number of signals received in a given time. These can be decoded into the values of the various weather factors automatically observed at the distant place. In some cases automatic recording receivers may be used.

Although the new radio weather robot offers undeniable advantages over the radio sonde, the latter will continue to be for some time an important adjunct to Mr. Weather Man, because it makes available information concerning conditions of importance in the determination of forthcoming weather at high altitudes. The balloon-lofted radio sonde can reach heights exceeding those which even stratosphere-flying airplanes cannot yet achieve. Here, 6 miles in the air, the radio sonde goes into action, and transmits dots or dashes which, picked-up and recorded at a sensitive receiver, are later interpreted by weather experts in terms of barometric pressure, air temperature, and relative humidity; the remaining factors of wind velocity and direction may be found by visual inspection or radio bearings.



Photo—Science Service
Wilbur S. Hinman, Jr., left, radio engineer of the National Bureau of Standards, and C. A. Kelly, chief aerographer of the U.S. Naval Air Station, Anacostia, D. C., watch the self-contained weather observing station observe the storm that is coming. The record untouched by human hands is sent by radio to a distant office. (See photo on cover.)

RADIO AT THE CONVENTIONS

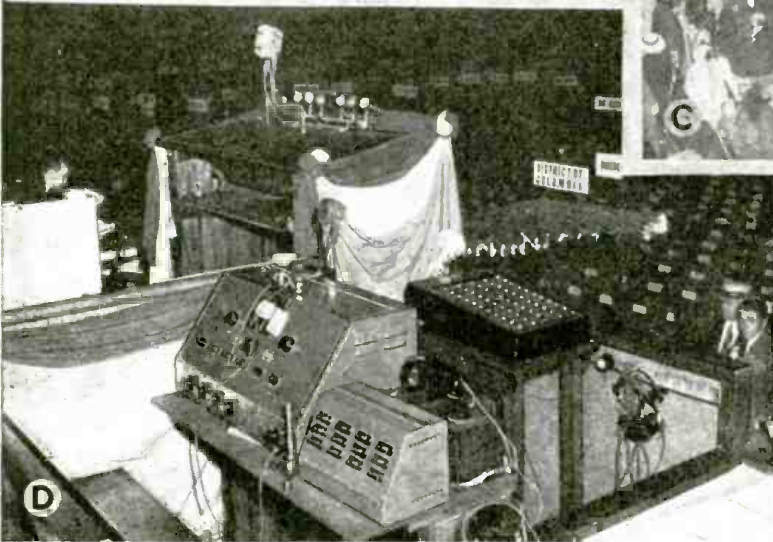
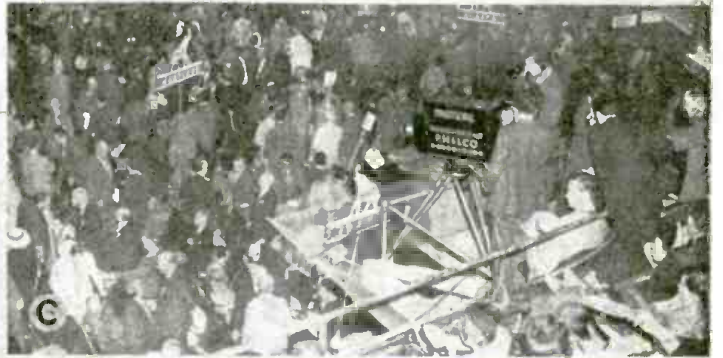

SOME idea of the extent to which radio facilities will be harnessed in the forthcoming presidential election may be surmised from the radio activities during the recent Republican and Democratic National Conventions. (The Republicans held forth in Philadelphia's Auditorium Convention Hall. The Democrats gathered in Chicago Stadium Convention Hall.)

The accompanying illustrations serve in some measure to picture these activities as follows:

(A) The No. 1 hope of the Republican Party, Mr. Wendell Willkie, is here shown in his Philadelphia hotel room where broadcast technicians are picking-up the Willkie end of a conversation to party leaders in another part of town; (B) at the Republican Convention C.B.S. special events announcers broadcast from the floor of the Hall by means of portable pack transmitters; (C) at this same convention the equipment here illustrated was employed in a Mutual-Philco broadcast and television tieup; (D) view of the chairman's rostrum in Philadelphia during rehearsal. The W.E. 6-way microphone is conspicuous among a number of others (control equipment shows clearly in this view); (E) despite

the difficulty of obtaining a good photograph of a television image, N.B.C. succeeded in photographing an image of former President Herbert Hoover, speaking before the G.O.P. Convention, as received in New York over a long-distance link which included 98 miles of Bell Labs. coaxial cable; (F) N.B.C./RCA television engineer at the television control equipment. Note that the apparatus is in duplicate.

HIGHLIGHTS

Broadcasts of the proceedings at the Democratic Party Convention in Chicago which nominated Franklin D. Roosevelt for a 3rd term as President of the United States, climaxed a series of network programs from Philadelphia where Wendell L. Willkie received the G.O.P. Convention nomination on the Republican ticket. Following are some of the technical highlights in back of these programs.

Each network had its own, air-conditioned control booth, but all cooperated in the installation, maintenance and use of the roughly 80 microphones used in each Hall. The networks staffs required at each convention totaled about 90 persons (technicians, announcers, etc.). Teletype machines permitted written orders to be exchanged almost instantly between broadcast headquarters in the convention cities, and the home offices. The use of special wooden aisle flooring, with spurs to key seats, solved the problem of protecting mike cables laid over the terrazzo (cement) floor in Chicago's Hall.

Convention programs were aired on S.W. amplitude modulation over international shortwave station WRUL (World Broadcasting Foundation); and over W2XOR, WOR's F.M. station, on frequency modulation.

Televised Republican proceedings in the Friendly City were sent by coaxial cable to New York and there transmitted by television to receiving sets in the metropolitan area. To afford "television coverage" to the Democratic politicians in the Windy City, as well, the activities were put on special talking motion picture film which was then rushed by Pathe News to New York via airplane and then sent over W2XBS to televiewers in the Metropolitan area.

N.B.C. treated the lens systems of its 4 television cameras with magnesium fluoride which increased the transmission of light through the lens systems about 30%. An Orthicon camera, 7 times more sensitive than the 3 Iconoscopes, was used for all the major pick-ups.

Parabolic microphones were used for picking-up crowd noise. Back-pack and "beer mug" portables were used in crowds where trailing wires could not be tolerated; 2-way ultra-shortwave interphones not only made it possible to monitor these portables but also afforded radio cueing channels; other cueing channels were provided by wire-interphones.

Sound motion picture companies utilized radio facilities (the newsreel companies did not set-up their own microphones but piped sound off from the radio channels). Sound recording engineers and their equipment were adequately provided for at both conventions. Public address systems in both auditoriums received, through the control booths, practically the same convention fare as the networks received. Several hotels in New York and Chicago received the same P.A. programs from the conventions over special direct wires and fed them over the hotels' public address systems and to the rooms of their guests!

NEXT MONTH

... An amplifier designed especially for recording sound; by A. C. Shanley. Don't miss it. Reserve your copy NOW!

MEISSNER—and F-M

the only COMPLETE line
for Listeners and Experimenters

CONSOLE F-M RECEIVER

For highest quality, noiseless, static-free reproduction of Frequency Modulated Broadcasts, this big console receiver is the finest obtainable!

Its powerful, 13-tube chassis, with built-in super-sensitivity, together with a special high-fidelity P-M Dynamic speaker in the large bass-reflex tone chamber assure the discriminating listener of maximum satisfaction. Covers the complete F-M frequency range (42 to 50 MC) and is provided with a very flexible five-position "tone" control—exactly the right quality at your fingertips!

The large, walnut-finished cabinet is a work of art in itself—41 inches high, 30 3/4 inches wide and 15 1/2 inches deep—massive, but well proportioned. The special bass-reflex tone chamber is completely enclosed at the rear for most effective baffling. Rich, two-toned veneers provide a beauty seldom seen except in the highest-priced receivers.

Model 9-1037 List \$135.00

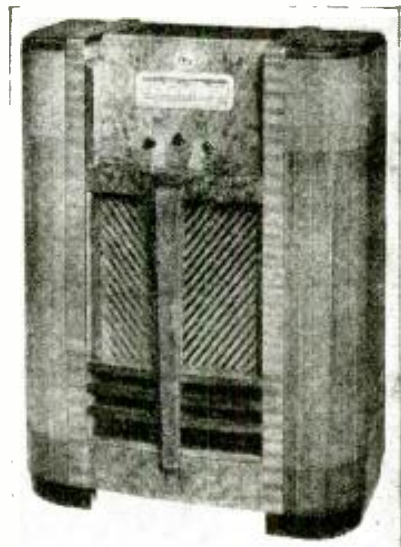

TABLE MODEL F-M RECEIVER

This model is identical in all respects to the Console Model described above except for the size and shape of the cabinet. Uses the same 13-tube chassis and same high-quality P-M speaker. Housed in a beautiful two-tone walnut cabinet, 12 1/4" high, 22 3/4" wide and 11" deep it provides a convenient economy of space but at the same time, permits a quality of reproduction impossible with an ordinary type receiver.

Model 9-1023 List \$99.25



R-F TUNING ASSEMBLY

For the experimenter who wants to build his own! Complete "front end" of the F-M receiver, wired and tested, ready to install in chassis as single unit.

01340 List \$21.50



4.3 MC I-F TRANSFORMER

Special, wide-acceptance band I-F transformers designed for all stages between the mixer and limiter tubes. Double-tuned, set at 4.3 MC.

01348 List \$1.75



DISCRIMINATOR TRANSFORMER

The "heart" of the F-M receiver, this wide-band transformer is specially designed for its important position between the limiter and detector. Air-tuned.

01350 List \$6.00

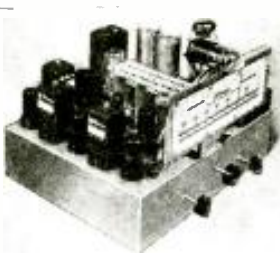

F-M CHASSIS ONLY

The same chassis used in both the above receivers—separately available for installation in your own cabinet! Complete and ready to operate, less tubes and speaker. See it at your Jobbers!

9-1041 List \$68.30

Ask About the New Meissner Recorders!

ORDER THIS INSTRUCTION BOOK

See your Jobber at once or send 50c direct for your copy of the big 168-page Meissner Instruction Manual. Contains latest data on Frequency Modulation, complete circuit and pictorial diagrams on Meissner kits.

ASK FOR FREE CATALOG

Get your name in early! Brand new Meissner General Catalog will be ready soon. Lists hundreds of items of interest to the serviceman and experimenter. You can't afford to be without it. Order yours today!

ADDRESS DEPT. C-10





In this article the latest-type miniature portables come in for review. How they operate, how they differ, what their circuits are, etc., are all comparatively surveyed. More such receivers will gradually appear on the market. Keep pace with them. Read this article to learn about the first group.

← New miniature portables. Left to right: RCA BP-10 (chassis RC-544); Emerson DU-379; Philco PT-89 (41-89).

THE NEW MINIATURE PORTABLES

N. H. LESSEM

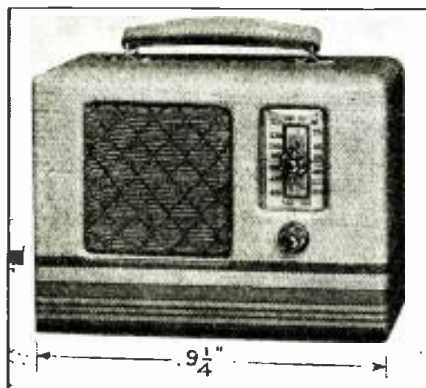

Automatic Radio Co.'s "Tom Thumb" miniature portable set.

PORTABLE radios are at last portable! The radio industry has been advertising portable receivers for many years but the lightest of them weighed more than 14 lbs.—portable in a manner of speaking. Now, at last, RCA has developed a *really* portable job, weighing no more than 4½ lbs. "on the hoof," and being no larger than a fair-size camera. Indeed it even looks like a camera.

WHY THE SUDDEN POPULARITY?

What has made the belated appearance of these portables at last possible? Certainly we have had battery sets before, we have had loop antennas before, and we have had specially-designed battery tubes before, but we have never had a truly *personal* "radio." Dealers everywhere are reporting rapidly growing backorder lists of customers who want these portables faster than they can be produced at the present time. This seems to prove that there is a distinct demand for a set of this type, apart from any other type of radio receiver now available.

Five important developments made the design of these sets possible.

No. 1—The introduction of the new miniature-type, thumb-size tubes* which operate on 1.4 V. filament supply, put an almost negligible drain of 50 milliamperes (100 ma. for the power tube) on the "A" supply and operate efficiently with as little as 45 V. of "B" battery (and correspondingly low "B" current). These tubes are just short of 2 ins. in height and ¼-in. in diameter—about the size of a well-developed peanut.

No. 2—The development of iron-core R.F. and I.F. components which permit these units to be manufactured in considerably smaller dimensions than is possible with the customary air-core construction.

No. 3—The loop antenna. Although this is a familiar device to oldtimers, it has always been a large and unwieldy affair. Today, it has been engineered down to extremely fine proportions, without any practicable loss in efficiency of operation.

No. 4—The development of the permanent-magnet dynamic speaker which in turn is an outcome of the development of the "Alnico" nickel-iron cast-alloy magnet.

No. 5—The development of the small-space-type "B" batteries. Being constructed on the principle of the Voltaic Pile they require minimum space for a given watts output.

Of 4 miniature portables recently placed on the market—RCA, Emerson, Philco and Automatic—the RCA instrument is the smallest and most conveniently carried. All use the new miniature-type tubes except Philco. This instrument uses a new series of small-size "Loctal" tubes, which though somewhat larger than the new "miniatures," have been specially designed for efficient operation on 45 V. of "B" power.

All the portables, however, use small-size P.M. dynamics, 4-tube superheterodyne circuits, directional loop antennas, and A.V.C.

* "Radically New Miniature 'Button'-Bottom Tubes," Radio-Craft, Feb., 1940, pg. 463.

RCA

The RCA portable as previously stated, weighs no more than 4½ lbs. and is no larger than a fair-size camera, in fact it even looks like one. Its actual dimensions: 9 x 3½ x 3 ins. deep. The rear cover, held closed by a snap catch, requires no tools to open it for battery or tube replacements.

The tuning range is 540 to 1,600 kc. The set as shown in the photo is equipped with a handle but a shoulder strap also is available.

The receiver is designed for operation on a single 1½-V. cylindrical "A" cell of the flashlight "D" size (such as Eveready No. 950); and a single 67½-V. "B" battery (such as Eveready 467). The batteries must be of the correct dimensions to fit inside the back of the receiver as shown in the photograph and also must be of the correct voltage. The set's total "A" current consumption is 0.25-ampere. The total "B" current consumption is 8.5 milliamperes.

The following observations concerning the power supply are almost equally applicable, except where otherwise noted, to all the miniature portables so far to come to the attention of *Radio-Craft*. The "A" supply requires more frequent replacements than the "B"—10 or more "A" cells may be required during the life of one "B" battery. The average life of the single-cell "A" supply is estimated to be between 2 and 3 hrs. of continuous playing. Intermittent life of the "A" cell is 3 to 5 hrs.; and for the "B," 25 to 40 hrs. When replacing batteries Servicemen should always suspect the "A" unit before the "B" unit. It is further recommended that if the receiver is not in use for a long period of time, the "B" battery should be removed. This will avoid the possibility of the battery chemicals causing the wrapping to expand and thus damage parts of the set. Another point to keep in mind is that reasonable care should be taken to obtain rated life from the batteries;

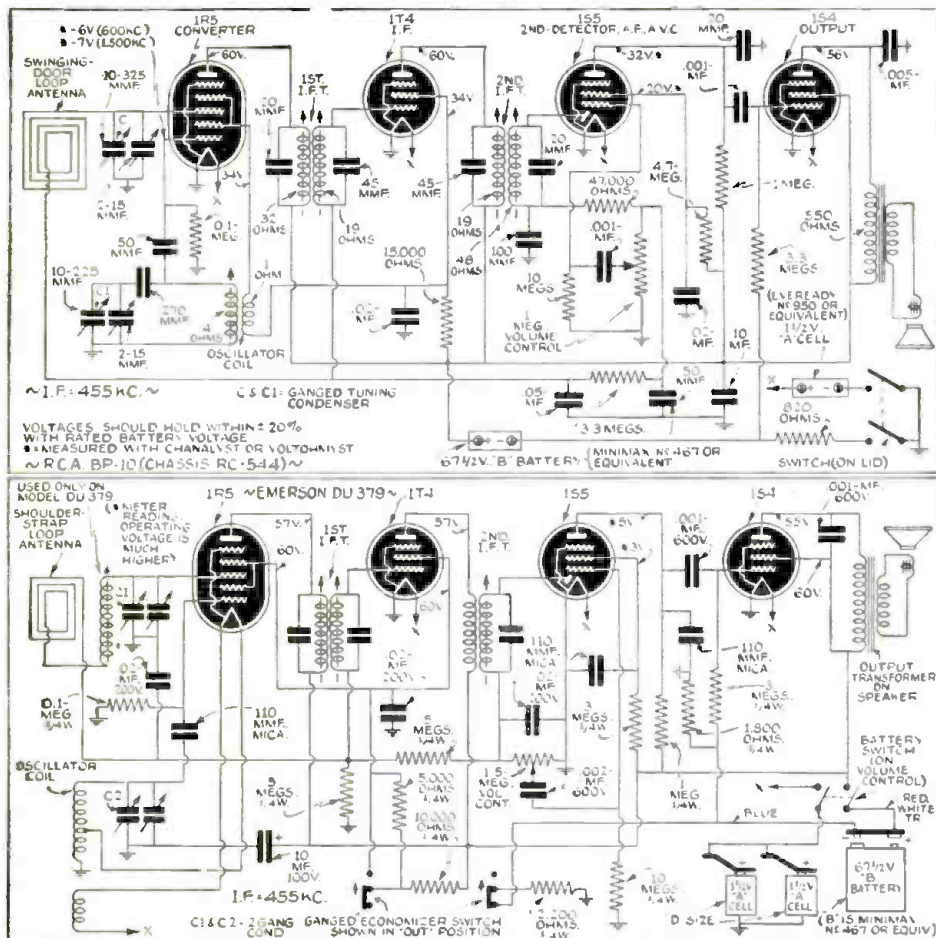

The RCA model BP-10 (chassis RC-544), top diagram, includes the entire inductance of the loop antenna in the tuned circuit. This loop by being molded into the lid is permanent in its characteristics. The Emerson model DU-379, second diagram, includes in the shoulder-strap loop antenna only a small portion of the total loop inductance, the remainder being lumped in a coil included in the chassis assembly.

miniature portables therefore should not be left in the direct noonday sun or placed on a radiator, for instance, as excessive heat tends to shorten the life of any battery.

The tuning and volume controls consist of 2 knurled finger-wheels extending through slits through the front panel just under the lid. Inasmuch as the lid of this portable not only has a loop antenna molded into it but also operates the on-off switch, it must be closed in order to shut off the receiver. The undistorted power output of the RCA receiver is 50 milliwatts. The 1S4 output pentode is connected in class A. Excellent tone quality can be obtained from the 3-in. speaker if care is taken not to overload it.

The final touch in personalizing this set is the blank area provided in the center of the steel top-panel for engraving initials.

EMERSON

The Emerson receiver (model DU-379), somewhat larger in cubic dimensions than the RCA job, measures 8 x 5½ x 2½ ins. deep. The frequency range of this set is 540 to 1,730 kc. The loop antenna is contained in the shoulder strap, hence the strap must be kept open about the same width as the case in order to properly pick-up signals. (The DU-380 has a handle and door-built-in loop antenna.) Set, complete, weighs about 5 lbs.

A tell-tale flag indicates when the set is turned on. The back cover, conveniently removable for battery replacements, is held on by a large-head screw which a coin used as a screwdriver will fit.

The receiver circuit is roughly similar to that of RCA's except for the oscillator design, that utilizes an arrangement which is

most unique; feedback voltages are obtained from the filament circuit (see diagram). An interesting invention is the "Battery Saver Switch" which in the "in" position increases the control-grid bias voltage of the 1S4 output tube and changes the screen-grid voltage of the 1T4 I.F. tube. Bias for the 1S4 tube is obtained across resistor R11. The voltage drop across this resistor should be 7.5 V. with the battery saver switch "out" or 9.4 V. with the battery saver switch "in." Two 1½ V. D-size flashlight "A" cells and one 67½-V. "B" battery are employed. The "A" current drain is 0.25-ampere. The "B" power consumption is 7.5 milliamperes with the battery saver "out," and 5.5 milliamperes with the battery saver "in"; with the battery saver in use the "B" battery life is extended more than the roughly 30% seemingly indicated above, or about 50%.

PHILCO

The Philco "Transitone" portable, like the Emerson, is a shoulder-strap affair, that is, the loop antenna is built right into the strap. The antenna, states the manufacturer, is self-shielding because it has low impedance, and hence is noise-reducing. The

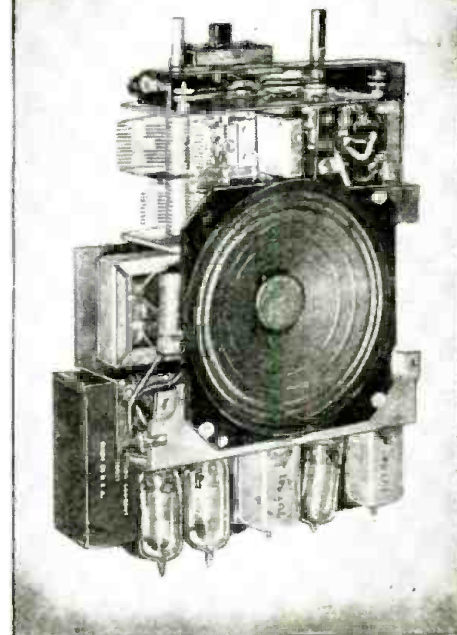
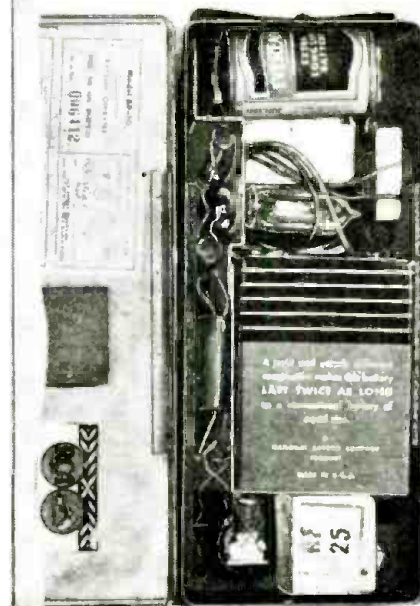
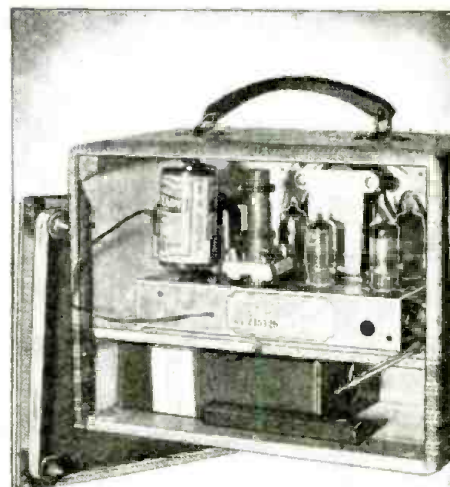

RADIO DEVELOPMENTS

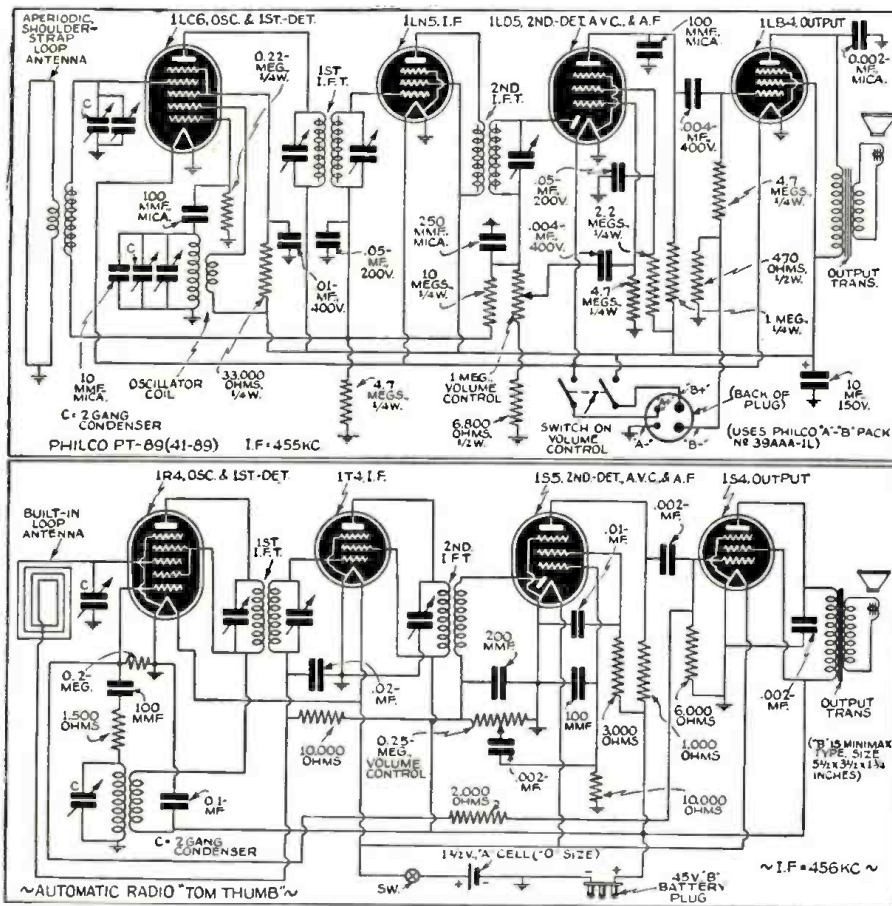

Complete schematic diagrams, including component values, of (top) Philco Model PT-89 and, (above) Automatic Radio Model "Tom Thumb". Latter uses the miniature tubes; former, a new series of special 1.4-V. single-ended tubes.

strap portion of the antenna system is substantially aperiodic (only slightly tuned); this design represents a new departure in that the tuning condenser does not directly tune the strap-loop antenna.

It weighs only 5 lbs. and is less than 5 ins. high. Its overall dimensions are: 5 x 10 x 4 ins. deep.

As mentioned in the preceding paragraphs this receiver does not use strictly miniature-type tubes (as they are now called) but rather a new series of "Loctals" specifically designed for low "B" voltage operation. The type numbers are: 1LC6, 1LN5, 1LD5 and 1LB4. The receiver uses a single 1½ V. flashlight type "A" cell and 45-V. "B" battery.

"TOM THUMB"

Automatic Radio & Television Co.'s (Inc.), "Tom Thumb" portable cannot strictly be called a miniature type. It is half-way in size between the familiar 3-way portables which have become so popular in recent years, and the new, ultra-small miniatures described above. The design of the cabinet and chassis also follows the more conventional layouts of the larger portables.

To replace the single "A" cell you have only to reach through an open window in the back and yank the old cell out of its spring holder and snap the new one in its place. The receiver measures 10 x 7½ x 5½ ins. deep, and weighs but 5 lbs.

Its circuit utilizes the new miniature-type 1.4 V. tubes, consequently, there is plenty of room to spare inside the new cabinet, permitting the use of a larger P.M. dynamic speaker; and, the use of a larger 45-V. "B" battery. Hence, in connection with the 1st item better tone quality may be expected; and in connection with the 2nd, much greater time will elapse before it becomes necessary to replace the "B" battery.

Mr. Radio Serviceman:

RSA MEANS BUSINESS!

New business promotion plans and new member-helps spell increased profits for RSA members at the start of the new season. Watch for the RSA Replacement Parts Guide—New Broadcast Promotions—New Member Helps! Don't be the last man in your neighborhood to join RSA. Send the coupon Today!

MAIL THIS COUPON NOW!

RADIO SERVICEMEN OF AMERICA, INC.
304 S. Dearborn St., Chicago, Ill.

I am interested in RSA Membership. Tell me about it.

Name

Address

City State

RC-1040

Let's Grow Together
in 1940!



RADIO SERVICEMEN OF AMERICA, Inc.

Reliable Service Assured

JOE MARTY, JR., EXECUTIVE SECRETARY
304 S. DEARBORN STREET, CHICAGO, U.S.A.

NEW LINE OF TUBES

Emerson Radio & Phono Corp.
111 8th Ave., New York, N. Y.



THIS company last month announced its entry into the radio tube replacement field.

The line will include Glass, Metal, Loctal, GT and Miniature types. The first 4 of the latter are illustrated. The characteristics of these tubes, the 1R5, 1S4, 1S5 and 1T4, are equivalent to those given for these types in the February, 1940, issue of *Radio-Craft*, pg. 465.

These tiny Emerson tubes are introduced in the miniature portable receiver described elsewhere in this issue.—*Radio-Craft*

NON-INDUCTIVE WIRE-WOUND RESISTORS

International Resistance Co.
401 N. Broad St., Philadelphia, Pa.



A COMPLETE new line of non-inductive wire-wound power resistors from 10 to 200 W. By utilizing the so-called Ayrton-Perry type of winding, large differences in potential as well as distributed capacities which exist between adjacent turns are eliminated. Available with all types of mountings.—*Radio-Craft*

FLASHLIGHT BULB EXTENSION

Sierra Aircraft Co.
Sierra Madre, Calif.



A NOVEL flashlight bulb extension which may be used to extend the light of a flashlight bulb through any maze of wires behind or around equipment and in other

tight squeezes. The unit is bendable, which makes it flexible in use. It is made of enamel-covered wire tightly encased in aluminum alloy tubing. Made in lengths from 6 to 36 ins.—*Radio-Craft*

ELECTRONIC VOLTMETER

Supreme Instruments Corp.
Greenwood, Miss.



MODEL 549 is a multi-meter instrument with bridges for A.C. and output volts, D.C. measurements, etc., in addition to an electronic circuit for D.C. voltage and resistance requirements.

Ranges: 0.1 to 6,000 V. D.C. in 6 overlapping steps (input impedance at 6,000 V. is 150 megohms; other ranges, 15 megohms); 0.5 ohm to 1,000 megohms in 5 overlapping steps. An electronic circuit in the ohmmeter allows the 1,000-megohm range to be reached with a 3-V. self-contained battery; 0.1-V. to 500 V. A.C. covered in 5 overlapping steps; 10 micro-amperes to 15 amperes D.C. covered in 7 steps; 0.1- to 500 V. output covered in 5 steps. A polarity-reversing switch affords tests with either polarity at a given prod. The voltage ranges are said to be calibrated to $\pm 3\%$.—*Radio-Craft*

COMMUNICATIONS RECEIVER

Howard Radio Co.
1731 Belmont Ave., Chicago, Ill.



KNOWN as model 490 this new communications receiver features 14 tubes, a range of 540 kc. to 43.5 mc. (550 to 7 meters) covered in 6 bands, calibrated band spread, variable-selectivity I.F., variable-fidelity audio system, temperature-compensated oscillator, air-tuned I.F. transformers, and split-stator, ceramic-insulated tuning condensers.—*Radio-Craft*

CONDENSER "EXAM-ETER"

Solar Mfg. Corp.
Bayonne, N. J.



MODEL CE condenser "Exam-Eter" is a condenser tester claimed to be the quickest and simplest on the market. Measures condensers both in and out of circuits. Tests for shorts, opens, high R.F. impedance and intermittents. Incorporates a capacity and resistance bridge, a megohm meter and a milliammeter. Measures power factor. May also be used as a D.C. and A.C. voltmeter.—*Radio-Craft*

NEW PHONE HANDSET

Universal Microphone Co., Ltd.
Inglewood, Calif.



A NEWLY-DESIGNED aircraft-type handset which replaces all preceding models. Finished in black bakelite and provided with 6 ft. of heavy-duty cord. In

addition to its use on aircraft it may be used for amateur rigs, mobile and pack transmitters, and 2-way telephone systems. Microphone and receiver terminate separately. Receiver is available in 2 resistance values, viz, 78 ohms for matching line impedance and 2,000 ohms for matching plate circuit of output tubes.—*Radio-Craft*

CIRCUIT TESTER

The Radiotechnic Laboratory
1328 Sherman Ave., Evanston, Ill.



MODEL 300 circuit tester uses a large 7-in. meter incorporating D.C. voltage ranges at 5,000 ohms/volt. Suitable for radio, sound and television industrial and service work.

Complete ranges of this flexible instrument are: 7 D.C. voltage ranges—0-12 V. to 0-1,200 V. at 5,000 ohms/volt, and 0-6,000 V. at 1,000 ohms/volt; 7 A.C. voltage ranges—0-12 V. to 0-6,000 V. at 1,000 ohms/volt; 7 D.C. ranges—0-3 ma. to 0-30 amps.; 5 ohmmeter ranges—Lo-ohm, 0-100, hi-ohm, 0-10,000, 0-0.1-meg., 0-1 meg., 0-10 megohms. All resistance ranges operated from internal batteries; 6 output ranges—0-12 V. to 0-1,200 V.; 2 V.-T.V.M. ranges—0-10 V. and 0-20 V.; D.C. ranges for measurements of grid, A.V.C. and discriminator voltages; A.C. operation for V.-T.V.M. heater automatically turned on when V.-T.V.M. circuit is selected; 6 db. ranges—decibels in terms of AC. volts scale on chart provided; 6 v.u. ranges—volume units in terms of A.C. volts scale on chart provided.

Accuracy is $\pm 2\%$ on D.C. volts and D.C. ma. ranges, and $\pm 4\%$ on A.C. volts ranges. Case measures $13\frac{1}{2} \times 11\frac{1}{2} \times 5\frac{1}{2}$ ins.—*Radio-Craft*

MARINE RADIO TELEPHONE

Western Electric Co.
195 Broadway, New York, N. Y.

MODEL 226C is a marine-radio telephone, 25 W. output, designed especially for "deep-sea" yachtsmen and for commercial ships.

Installation is simple involving connection only to the antenna, ground and power supply. A single control shifts both transmitter and receiver simultaneously to any one of 4 frequencies. Three frequencies may be utilized for ship-to-shore commu-

GEOPHYSICAL PROSPECTING OUTFITS



BLUE PRINTS and INSTRUCTIONS

For Building the Following Treasure Finders and Prospecting Outfits

- Folder No. 1. The "Radio-Reflector Pilot"—consists of a 2-tube transmitter and 3-tube receiver. Principle: radiated Wave from transmitter loop is reflected back to receiver loop. Emits visual and aural signals. Tubes used: two 1A5G—two 1N5G—one 1H5G.
- Folder No. 2. The "Harmonic Frequency Locator"—Transmitter radiates low frequency wave to receiver, tuned to one of Harmonics of transmitter. Using regenerative circuit. Emits aural signals. Tubes used: one 1G6G—one 1N5G.
- Folder No. 3. The "Beat-Note Indicator"—Two oscillators so adjusted as to produce beat-note. Emits visual and aural signals. Tubes used: Three type '30.
- Folder No. 4. The "Radio-Balance Surveyor"—a modulated transmitter and very sensitive loop receiver. Principle: Balanced loop. Emits visual and aural signals. By triangulation depth of objects in ground can be established. Tubes used: Seven type '30.
- Folder No. 5. The "Variable Inductance Monitor"—a single tube oscillator generating fixed modulated signals and receiver employing two stages R.F. amplification. Works on the inductance principle. Emits aural signals. Tubes used: six type '30.
- Folder No. 6. The "Hughes Inductance-Balance Explorer"—a single tube Hartley oscillator transmitter and sensitive 3-tube receiver. Principle: Wheatstone bridge. Emits aural signals. Tubes used: two type '30—one type '32—one type '33.
- Folder No. 7. The "Radiodyne Prospector"—a completely shielded instrument. Principle: Balanced loop. Transmitter, receiver and batteries enclosed in steel box. Very large field of radiation and depth of penetration. Emits aural signals. Tubes used: two 1N5G—one 1G4G—one 1H5G—one 1Q5—one 1G4.

With any one of the modern geophysical methods described in the Blue-Print patterns. Radio outfits and instruments can be constructed to locate metal and ore deposits (prospecting); finding lost or buried treasures; metal war relics; sea and land mines and "duds"; mineral deposits; subterranean water veins; oil deposits (under certain circumstances); buried gas and water pipes; tools or other metallic objects sunken in water, etc., etc.

Each set of blueprints and instructions enclosed in heavy envelope (9 1/2" x 12 1/2"). Blueprints 22" x 34"; eight-page illustrated 8 1/2" x 11" fold. or of instructions and construction data ... **50¢**
Add 5¢ for postage

The complete set of seven folders..... **\$3.00**
Shipping weight 2 lbs. (add 25¢ for shipping anywhere in U.S.A.)

TECHNIFAX

RC-1040
1917 S. STATE ST. CHICAGO, ILL.

TECHNIFAX 1917 So. State, Chicago, Ill.

Enclosed herewith \$..... for which mail to address below:

Treasure Finder No. 1. 2. 3. 4. 5. 6. 7.
Complete set of seven folders.

NAME

ADDRESS

CITY STATE

RC-1040

nication and the 4th reserved for ship-to-ship or Coast Guard. All controls are on the front panel. Other features include crystal control for receiver and transmitter; and semi-automatic operation. Operates from 115-V. 60-cycle A.C. source which may be supplied by a small rotary converter; designs for other power sources are available. Built-in speaker permits monitoring incoming calls; dial calling is optional.—Radio-Craft

"BABY" CONNECTORS

Selecter Mfg. Corp.
30 West 15 St., New York, N. Y.

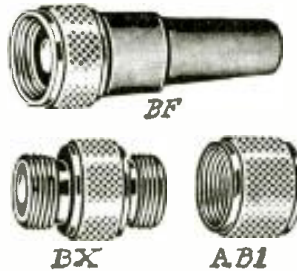

NEW small-size locking-type shielded conductor cable connectors designed to improve contact and minimize interruption of circuits. Recommended for quick and positive connection of microphones, speakers and chassis. "Baby" types BF, AB1 and BX are illustrated.—Radio-Craft

QSL CARD ALBUM

Gordon Specialties Co.
1104 S. Wabash Ave., Chicago, Ill.



At last the hams can remove their QSL cards from their walls and paste them in a regular album. The pages are loose-leaf and hold 4 cards each. Stubs between sheets prevent bulging. Has 50 pages. Cover made of grained red Morocco material with ham's call letters embossed on it.—Radio-Craft.

TELESCOPIC TRANSFORMERS

The Kenyon Transformer Co., Inc.
840 Barry St., New York, N. Y.

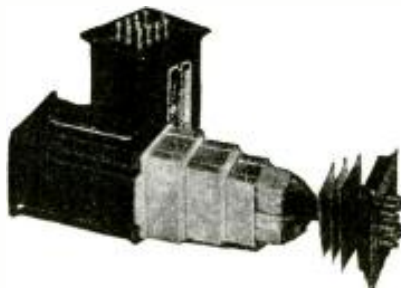

ILLUSTRATED is one of a new line of telescopic shielded hum-bucking transformers. These transformers are annealed after complete construction to remove all banding and shearing strains incurred during manufacture. This extra process, it is claimed, assures maximum permeability of

the electromagnetic shields. Available in 2 types. Type P204 has a primary of 500/333/250/200/125/50 ohms and secondary of 50,000 ohms (single class A grid). Frequency response, ± 1 db., is 30 to 20,000 cycles. Shielding, 90 db.

Type 205 has a primary the same as P204 and a secondary of 0.1-meg. to push-pull grids. Frequency response, ± 1 db., is 30 to 20,000 cycles. Shielding, 90 db.—Radio-Craft

ELECTRONIC BRIDGE

The Hickok Electrical Instrument Co.
10514 Dupont Ave., Cleveland, Ohio



BESIDES being used as a conventional bridge this tube-type instrument, model 575, may be used as a percentage bridge and also as a synchronometer. It permits electrical triangulation which is not pos-

DATAPRINTS



- TESLA-ODDIN HI-FREQ. COILS**
20c Ea. in order for 10 (Data and Drawings only.)
36" Sp'k Tesla-Oudin Coil 40c (1 K.W. Exc. Trf. Data, included FREE!)
- 8" Sp'k Tesla-Oudin Coil 40c (1/4 K.W. Exc. Trf. Data, included FREE!)
- 3" Sp'k Oudin; 110 Vt. "Kick Coil" type.....40c
- 3" Sp'k Tesla Works on Ford Sp'k Coil40c
- 1" Sp'k Violetta Hi-Freq. Coil.....40c
- Model Warships—Get List of Plans



Induction PIPE & ORE LOCATOR

Induction Type, Data40c
Radio Type40c

More DATAPRINTS 40c each!

- 5 Meter Superhet. Electric Refrigerator
1/2 Meter Tr. & Rec. Resistance Measuring
20 A.C. Probs. & Ans. Bridge
20 Telephone Hook-ups Weld. Transf. 2 K.W.
100 Mech. Movements Rewinding Armatures
20 Motor Hook-ups String Galvanometer
Television Hook-up 20 Simple Bell Circuits
20 Elec. Party Tricks Steel Wire Recorder!
Solenoids and Magnets —get list. Water Wheels or Turbines
Fry Eggs on Ice! Turbines
Experimental Photophone Photo Cell and Relay
Radio Control for Ring 4 bells; 2 Wires
Models. 20 Tesla Tricks
Diathermy Apparatus Polarized Relay
Inductor OrFan Induction Balance

Special Prices: 4 prints \$1.00; 10 for \$2.00; Single, 40c each. Get New Catalog 100 A.

The DATAPRINT Co.
Lock Box 322C, Ramsey, N. J.

sible with conventional bridges. The shielded circuit features a cosine galvanometer and has built-in standards and provisions for external standards. Despite the fact that the instrument operates on A.C. it has null balance same as all standard D.C. bridges. Measurements include capacity (from 1 mmf. to over 1,000 mf.), resistance (to 500 megohms.), inductance, impedance, power factor and frequency.—*Radio-Craft*

AUTOMATIC RECORD CHANGER

The General Industries Co.
Elyria, Ohio



THIS equipment plays 12 10-in. or 10 12-in. records automatically. Handles records with either run-in or oscillating trip grooves. The pickup arm is supported at times when not resting on records. Means are provided for guiding pickup needle into the plain groove on records without lead-in groove. A single lever is used to change mechanism from playing one size record or another. The base plate measures 14 x 14 x 3/8 ins. Height, below lower edge of base plate, 5 7/16 ins., depth, below lower edge of base plate, 3 1/2 ins. Known as model GI-C120 this record changer is a 78 r.p.m. unit and is available for all commercial voltages and frequencies.—*Radio-Craft*

JEWEL PILOT LIGHT

Alden Products Co.
715 Center St., Brockton, Mass.

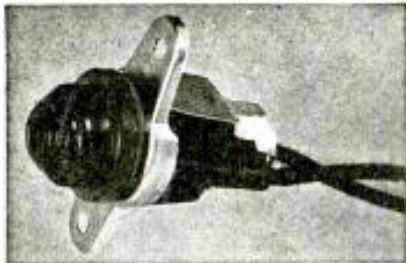

THIS assembly fastens to the panel with either eyelets, rivets or screws, thereby affording secure and permanent mounting. The indicating jewel, made from a translucent thermosetting material may be removed from the front for replacement of the pilot light.—*Radio-Craft*

MIDGET PERMANENT-MAGNET CABINET SPEAKER

Oxford Tartak Radio Corp.
915 W. Van Buren St., Chicago, Ill.

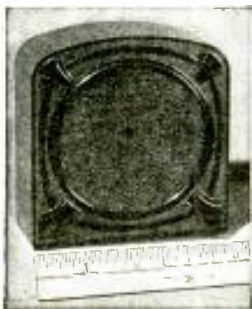

MEASURES 4 1/2 x 4 x 1 7/8 ins. It is an excellent extension speaker since it fits in any small nook or corner unobtrusively. Case is of walnut bakelite with fiber-board back. Spring-steel clips permit making connections to the voice coil. The



\$149⁵⁰

Complete with 14 Tubes.
External Dynamic Speaker
to Match and Crystal Filter

The New HOWARD "490"
Gives You "Plus" Performance all the Way!

- 14 Tubes
- 540 KC—43 MC
- 2 Stages R.F. Preselection
- Calibrated Band Spread
- Air-Tuned I.F. Transformers
- Variable I.F. Selectivity
- Temperature Compensated Oscillator
- Split Stator Ceramic Insulated Tuning Condensers
- Variable Fidelity Audio
- 8 Watts Push Pull Output
- Automatic Noise Limiter

A Communication Receiver that could truly be termed "tops" in every respect, the HOWARD Model 490 is the result of over a year's engineering and development. New standards of performance were set and are now available for the first time outside of laboratory equipment.

You will have—sensitivity that never knows "crowding"—selectivity that may be varied from crystal CW to wide band high fidelity—an audio system with flat response of 30 to 10,000 cycles—high or low frequency cutoff of a 1600 cycle peak—and all reproduced through a dynamic speaker having the best in both high and low frequency response.

Write the factory for complete technical manual on the great 490 and see your distributor for a demonstration.

HOWARD RADIO COMPANY

1731-35 Belmont Ave., Chicago—Cable Address: HOWARDCO, U.S.A.

Engineered and Built by America's Oldest Radio Manufacturer



New HOWARD "490"

speaker is known as model 3ZM-CA. A second similar unit, model 3ZM-CM, is designed for use as a microphone and is equipped with a special shielded transformer.—*Radio-Craft*

POWER TUBE TESTER

Harvey-Wells Communications, Inc.
Southbridge, Mass.

THIS instrument facilitates taking accurate measurements of power and receiver tube characteristics under variable load conditions. Type R-83 tester was designed specifically for airlines and other organizations maintaining large groups of transmitter installations. Rectifier tubes may be tested in either half-wave or full-wave circuits. The load is of such nature that the rectifier tube is subjected to its maximum peak inverse

A Useful Electric Dry Shaver—FREE!
See Page 254

FREE CATALOG



ALL RADIO NEEDS

Here in this one big book you will find everything you need in radio . . . sets, parts and supplies . . . public address systems . . . amateur equipment . . . testers and kits . . . Your nationally known favorites at lowest possible prices. Write today for this big valuable catalog and save money.

PROMPT SERVICE

BURSTEIN-APPLEBEE COMPANY
1012-14 McGEE STREET, KANSAS CITY, MISSOURI

SUPER BARGAINS

Practically all of the attractive items listed here are brand new, others are reconditioned like new; but ALL are in PERFECT WORKING ORDER. In many cases, the parts alone total more than the price we are asking. 100% satisfaction guaranteed or your money refunded. ORDER FROM THIS PAGE. Use the convenient coupon below. Include sufficient extra remittance for parcel post charges, else order shipped express, collect. Any excess will be refunded. C.O.D. shipments require 20% deposit. If full remittance accompanies order, deduct 2% discount. Send money order, certified check, new U. S. stamps. No C.O.D. to foreign countries.

ORDER TODAY LIMITED QUANTITIES PROMPT SHIPMENTS ASSURED

BRAND NEW! PHOTOELECTRIC RELAY KIT

For Burglar and Fire Alarm—Safety Devices—
Door Openers—Commercial Applications— etc.
NO BATTERIES TO REPLACE—
OPERATES FROM THE A.C. LINE



There are hundreds of different purposes for which a photoelectric kit of this type can be used and many times that number of useful and interesting experiments. For instance: It turns lights on automatically as night falls or turns them off again in the morning; you can project a beam of light at any point and count people as the beam is broken or you can count cars, check theatre attendance, start and stop machinery, detect smoke and arrest industrial accidents. Complete and fool-proof burglar and fire alarm systems may be set up with this kit—Inexpensive to operate, simple to install, unfailing in operation.

The kit consists of a high-sensitivity photo-electric cell, trigger-action relay, one stage of electric amplification and all resistors, wires, sockets and hardware to build the instrument for immediate service. Detailed instructions and sketches make wiring simple as ABC. You can have it working in a single evening with plenty of time to spare for several experiments. A sensitivity control regulates the amount of light that will operate the relay. This permits application to a host of important uses. The instrument works from the power line, 115 volts, 60 cycles, A.C.

The photoelectric relay unit is small (4 1/2 x 1 1/4") compact and light weight. Shipping weight 4 lbs.
ITEM NO. 91
YOUR PRICE \$7.94

G.E. INDUCTION DISC MOTOR FOR RECORDING PLAYBACK AND DISPLAY PURPOSES



Substantially constructed by General Electric, this ball-bearing motor is a high-quality phonograph unit. Its power and smooth-running make excellent home recording work. Its speed, governor-controlled, is variable both below and above 78 r.p.m. For 110 volts, 60 cycles, A.C. Solid less turntable and shaft. 7 1/2" diameter x 5 1/4" high. Shp. Wt. 14 lbs. Packed in Original Box.

ITEM NO. 81
YOUR PRICE \$3.95

SUPER SPECIAL 3 1/2 R.P.M. SYNCHRONOUS MOTOR

There are 101 uses for a synchronous motor making only 3 1/2 revolutions per minute. Ideal for crowd-catching store-window displays, agitating film-developing tanks, as an electric winch on model motor boats, as starting motor in erector sets, etc. Built in high-ratio step-down gears provide amazing amount of power. Made by Haydon Mfg. Co. of Waterbury, 2" in diameter x 2 1/2" x 1" thick overall. Shp. Wt. 2 lbs.



ITEM NO. 76
YOUR PRICE \$1.95

MECHANICAL FLASHLIGHT

This battery-less flashlight generates its own power merely by pressing handle. Gives strong light whenever needed. Costs nothing to maintain. Amazing new miniature dynamo operates flashlight. Pocket size. 4 3/4" x 2" x 1". Shp. Wt. 2 lbs.



ITEM NO. 88
YOUR PRICE \$1.70

AMAZING BLACK LIGHT!!

Powerful 300-Watt Ultra-Violet Bulb



The best and most practical source of ultra-violet light for general experimental and entertainment use. Makes all fluorescent substances brilliantly luminescent. No transformers of any kind needed. Fits any standard lamp socket. Made with special filter glass permitting only ultra-violet rays to come through. Brings out beautiful opalescent hues in various types of materials. Swell for amateur parties, plays, etc., to obtain unique lighting effects. Bulb only. Size of bulb.

Shp. Wt. 1 lb.
ITEM NO. 87
YOUR PRICE \$2.00

SUPER MAGNET

LIFTS MORE THAN 20 TIMES
ITS OWN WEIGHT

LITTLE GIANT MAGNET. Lifts 5 lbs. easily. Weighs 1 oz. Made of ALNICO new high-magnetic steel. Complete with keeper. World's most powerful magnet ever made. The experimenter and hobbyist will find hundreds of excellent uses for this high quality permanent magnet. Measures 1 1/4" x 1 1/4". Shp. Wt. 1/4 lbs.



ITEM NO. 86
YOUR PRICE \$1.00

BRAND NEW! BATTERYLESS CYCLE-LIGHT

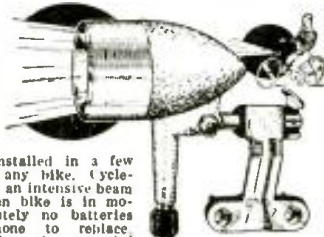

Can be installed in a few minutes on any bike. Cycle-Light throws an intensive beam of light when bike is in motion. Absolutely no batteries needed—none to replace. Costs nothing to operate! Small, built-in generator, turned by the bike wheel supplies unfailing current. Most economical headlight yet. Guaranteed for lasting performance. All metal construction with beautiful silver finish and polished chromium-plated reflector. Armature operates with a powerful Alnico General Electric permanent magnet. Measures 4" x 5 1/4". Complete with bulb and instructions, ready to attach. Shp. wt., 3 lbs.

ITEM No. 90
YOUR PRICE \$2.10

SEWING MACHINE MOTOR

For electrifying foot-treadle sewing machines and replacing burned-out motors on electrified machines. Powerful and high-speed; numerous other uses. Ideal as handy grinder-polisher motor. Small, compact, flat on two sides, requiring a minimum of space. Speed controllable by foot-pedal rheostat (available optionally for \$3.75). Its 1/2" diam. shaft is available with or without pulley (pulley 15c extra). Completely enclosed and dirt proof. Measures 3 1/2" x 5" x 2" overall. Shp. Wt. 7 lbs.



ITEM NO. 79
YOUR PRICE (motor only) \$3.75

voltage rating at the same time delivering the maximum peak plate current.

Individual power tubes are tested by means of a plug-in bakelite panel containing the proper socket and correct connections for the type of tube to be tested, and hence, automatically makes the proper connections (selection of meters, ranges, etc.). Tubes may be tested at under- or over-rating voltages. Each power tube is tested for full rated output at 8 mc. (or any other frequency if specified).—Radio-Craft

PHONO-RADIO-RECORDER

The Crosley Corp.
Cincinnati, Ohio



A 6-TUBE combination radio-phonograph and recording unit including table microphone. May be used as public-address system. May fade voice with radio or recording. Receiver covers broadcast, short-wave and police bands, and includes bass compensation, variable tone control and "Heliscope" built-in loop antenna. (This model 33BG is one in a group of receivers in a series, designated as the "glamor-tone," commemorating Crosley's 20th Anniversary. The entire line of more than 30 receivers of all types uses only 15 tube types.)—Radio-Craft

3-IN-1 PORTABLE COMMUNICATIONS RECEIVER

The Hallicrafters
2611 S. Indiana, Chicago, Ill.

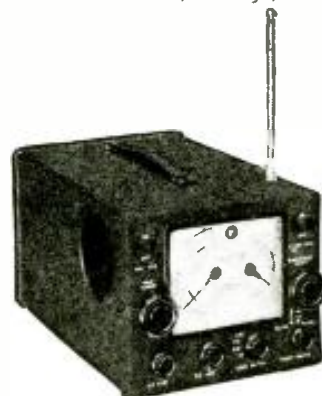

KNOWN as the model S-29 "Sky Traveler" this instrument makes available a complete communications receiver in the popular 3-in-1 portable style. That is, it operates on self-contained batteries or on 110 V. A.C. and/or D.C. Complete weight including batteries is 18 lbs. Built-in charging circuit increases life of batteries. The receiver is a 9-tube superhet. with a tuning range continuous from 542 kc. to 30.5 mc. in 4 steps; electrical band-spreading on all ranges. Sensitivity it is claimed averages better than 2 microvolts in all ranges.—Radio-Craft

HUDSON SPECIALTIES CO., 40 West Broadway, N. Y. C.

WE HAVE NO CATALOG. IT'S EASY TO ORDER—CLIP COUPON—MAIL NOW ORDER FROM THIS PAGE

HUDSON SPECIALTIES CO., 10 West Broadway, Dept. RC-1040, New York, N. Y.
I have circled below the numbers of the items I'm ordering. My full remittance of \$..... (include shipping charges) is enclosed. (20% required), ship order C.O.D. for balance. No C.O.D. for less than \$2.00. (New U. S. stamps, check or money order accepted.)
Circle Item No. wanted: 76, 79, 81, 86, 87, 88, 90, 91

Name Address

City State

Send remittance by check, stamps or money order; register letter if you send cash or stamps.

Where to Buy It!—

RADIO TRADE DIRECTORY

Handy Buying Guide, by Products and Manufacturers' Names and Addresses, for the Entire Radio Industry

Lack of editorial space makes it necessary to limit the Directory to a maximum of 5 pages monthly. Therefore, the entire directory will be presented in 4 consecutive issues. Every 4 months the Directory will be completely revised and thus constantly kept up-to-date.

While every precaution is taken to insure accuracy, Radio-Craft cannot guarantee against the possibility of occasional errors and omissions in the preparation of this Trade Directory. Manufacturers and readers are urged to report all errors and omissions at the earliest moment to insure corrections in the very next issue.

ANTENNAS & ACCESSORIES

- All-wave (home) AWH
 - Antenna eliminator AE
 - Auto A
 - Auto (vacuum type) AV
 - Built-in line antennas BLA
 - Frequency modulation FM
 - Ground clamps GC
 - Insulators I
 - Kits K
 - Lightning arrestors LA
 - Loop antennas LE
 - Master antenna systems MAS
 - Noise-reducing broadcast NB
 - Outlets O
 - Television T
 - Towers & supports (home) TS
 - U. H. fixed frequency coaxial UHFFC
 - Television, FM & AM comb. TFAC
 - Rhombic antennas resistors RAR
 - Coaxial Cables CC
 - Ultra-H.F. antennas UHFA
- ABC RADIO LABORATORIES, 3334 N. New Jersey St., Indianapolis, Ind., "ABC"—A
- AEROVOX CORP., 740 Belleville Ave., New Bedford, Mass.—NB
- AIRLINE, Montgomery Ward & Co.
- AIRPLANE & MARINE DIRECTION FINDER CORP., Clearfield, Pa.—LE (Direction Finding)
- ALDEN PRODUCTS CO., 715 Center St., Brockton, Mass.—K
- ALESİ & FENER, 132 Nassau St., New York, N. Y.—AWH, K, NB, T
- ALLIED RADIO CORP., 833 W. Jackson Blvd., Chicago, Ill., "Knight"—AWH, A, K, LE, MAS, BLA, GC, I, LA, NB, O, TS, FM
- ALPHA WIRE CORP., 50 Howard St., New York, N. Y.—AWH, GC, I, K, LE, LA
- AMERICAN COMMUNICATIONS CORP., 123 Liberty St., New York, N. Y.—AWH, GC, I, MAS, NB, O, BLA
- AMERICAN LAVA CORP., Cherokee Blvd., & Manufacturers Rd., Chattanooga, Tenn.—I
- AMERICAN PHENOLIC CORP., 1250 Van Buren St., Chicago, Ill.—CC
- AMERICAN RADIO HARDWARE CO., 476 Broadway, New York, N. Y., "Arhco"—A
- AMY, ACEVES & KING, INC., 11 West 42 St., New York, N. Y.—MAS, AWH, NB, O
- ANDREA RADIO CORP., 4820 48th Ave., Woodside, L. I., N. Y.—AWH, NB, T
- ARHCO, American Radio Hardware Co.
- ARVIN, Noblitt-Sparks Industries, Inc.
- CHARLES AVNET CO., 156 Chambers St., New York, N. Y.—AWH, A
- BASSETT RADIO MFG. CORP., Niles, Mich.—T
- BEE ENGINEERING CO., 7665 Grand River Ave., Detroit, Mich.—I, K
- BELDEN MFG. CO., 4647 W. Van Buren St., Chicago, Ill.—AWH, GC, I, K, LA, MAS, NB
- BENDIX RADIO CORP., 920 E. Fort Ave., Baltimore, Md.—LE

- BIRCO—Birnbach Radio Co.
- BIRNBACH RADIO CO., INC., 145 Hudson St., New York, N. Y., "Birco"—AWH, GC, I, K, LA, MAS, NB, O, T
- BOND PRODUCTS CO., 13139 Hamilton Ave., Detroit, Mich.—GC, A
- L. S. BRACH MFG. CORP., 55 Dickerson St., Newark, N. J.—AWH, A, GC, I, K, LA, MAS, NB, T, BLA, LE, O, FM
- BROWN MFG. CO., 403 W. Baltimore, Detroit, Mich.—K, FM
- BUD RADIO, INC., 5205 Cedar Ave., Cleveland, Ohio, "Bud"—I, O, BLA
- THE CARBORUNDUM CO., P.O. Box 337, Niagara Falls, N. Y.—RAR
- CLAMPIPE, Mueller Electric Co.
- CONSOLIDATED WIRE & ASSOC. CORPS., Peoria & Harrison Sts., Chicago, Ill.—A, AWH, GC, I, K, LA, MAS, BLA, LE, NB, O, FM
- CORNING GLASS WORKS, Walnut St., Corning, N. Y., "Pyrex"—I
- CORNISH WIRE CO., INC., 15 Park Row, New York, N. Y., "Noise-Master," "Corwico"—AWH, GC, I, K, LA, NB
- CORWICO—Cornish Wire Co., Inc.
- CRUMPACKER DIST. CORP., 1801 Fannin St., Houston, Tex.—AWH, A, GC, I, K, LA, NB
- DAVEN CO., 158 Summit St., Newark, N. J.—T
- DOOLITTLE & FALKNER INC., 7421 Loomis Blvd., Chicago, Ill.—A
- D-X RADIO PRODUCTS CO., 1575-1579 Milwaukee Ave., Chicago, Ill.—LE
- EAGLE ELECTRIC MFG. CO., INC., 59 Hall St., Brooklyn, N. Y.—AWH, GC, I, K, LA, O
- EFFARSEE—Fishwich Radio Co.
- EX-STAT—Tilton Electric Corp.
- FARNSWORTH TELEVISION & RADIO CORP., 3700 Pontiac St., Extended, Fort Wayne, Ind.—AWH, A, NB, T
- FEDERAL SALES CO., 26 S. Jefferson St., Chicago, Ill.—GC
- FISCHER DISTRIBUTING CORP., 222 Fulton Street, New York, N. Y., AWH, A, BLA, FM, GC, I, K, LA, MAS, NB, O, TS
- FISHWICH RADIO CO., 139 W. 4th, Cincinnati, Ohio, "Eiffarsee"—AWH, A, BLA, NB
- F & H RADIO LABORATORIES, Fargo, N. Dakota—NB, AE
- M. M. FLERON & SON, INC., 113 N. Broad St., Trenton, N. J., "Fleron"—AWH, GC, I, K, LA, NB, O, FM
- FOWLER MFG. CO., 9 Rutgers St., St. Louis, Mo.—AWH
- FULTON RADIO CORP., 100 6th Ave., New York, N. Y.—A, T
- GALVIN MFG. CORP., 4545 Augusta Blvd., Chicago, Ill., "Motorola"—AWH, A
- GENERAL CEMENT MFG. CO., 919 Taylor Ave., Rockford, Ill.—LA
- GENERAL CERAMICS CO., 30 Rockefeller Plaza, New York, N. Y.—I
- GENERAL CERAMICS CO., PLANT No. 3, Keasbey, N. J.—I, FM

- GE, General Electric Co.
- GENERAL ELECTRIC, 1 River Road, Schenectady, N. Y.—AWH, BLA, K, NB, FM
- GENERAL ELECTRIC CO., 1285 Boston Ave., Bridgeport, Conn., "GE", "V-Doublet"—AWH, NB, BLA, I, LA, MAS, FR
- GENERAL TELEVISION & RADIO CORP., 511 S. Sangamon St., Chicago, Ill., "Syn-crotenna"—AWH
- GENERAL WINDING CO., 154 W. 31st St., New York, N. Y., "Gen-Win"—AWH, K, MAS, NB
- GEN-WIN, General Winding Co.
- GOLDENTONE RADIO CO., 15123 Warren Ave., Dearborn, Mich.—AWH, A, K, NB
- D. H. HARRELL, 1527 E. 74 Place, Chicago, Ill.—MAS
- HARRISON RADIO CO., 12 West Broadway, New York, N. Y.—AWH, GC, I, K, LA, NB, TS, FM
- HOME RADIO SERVICE, INC., 521 West 48th St., N. Y., N. Y.—MAS
- HOPE WEBBING CO., P.O. Box 1495, Providence, R. I.—AWH
- HERBERT H. HORN, 1201 So. Olive St., Los Angeles, Calif.—AWH, A, BLA, I, K, LE, LA, NB, O, TS
- HOWARD RADIO CO., 1731 Belmont Ave., Chicago, Ill.—LE
- ICA, Insuline Corp. of America
- ILLINOIS SEATING CORP., 2138 N. Racine Ave., Chicago, Ill.—AWH, GC, MAS, NB, T, TS
- INSULINE CORP. OF AMERICA, 30-30 Northern Blvd., Long Island City, N. Y., "ICA"—AWH, A, GC, I, K, LA, O, TS, BLA, LE
- ISOLANTITE, INC., 233 Broadway, New York, N. Y., "Isolantite"—I, UHFA
- J. F. D. MFG. CO., 4111 Ft. Hamilton Pkwy., Brooklyn, N. Y., "JFD"—AWH, A, K, T, FM
- E. F. JOHNSON CO., Waseca, Minn.—I, FM
- KNIGHT, Allied Radio Corp.
- LAFAYETTE, Radio Wire Television, Inc.
- LEAR AVIATION, INC., Dayton Municipal Airport, Dayton, Ohio—K
- JOHN E. LINGE & SON, INC., 28th St. & Buren Ave., Camden, N. J.—FM
- FRED M. LINK, 125 W. 17th St., New York, N. Y.—A, UHFFC
- M & H SPORTING GOODS CO., 512 Market St., Phila., Pa.—AWH, A, GC, I, LA, MAS, NB, O
- MAJESTIC RADIO & TELEVISION CORP., 2600 W. 50 St., Chicago, Ill.—LE
- P. R. MALLORY & CO., Inc., 3029 E. Washington St., Indianapolis, Ind., "Yaxley"—O
- MIDWEST RADIO CORP., 909 Broadway, Cincinnati, Ohio—AWH
- JAMES MILLEN MFG. CO., INC., 150 Exchange St., Malden, Mass.—I
- MIMS RADIO CO., P.O. Box 504, Texarkana, Ark.—FM, RBA
- MONTGOMERY WARD & CO., 619 W. Chicago Ave., Chicago, Ill., "Airliner"—AWH, A, GC, I, K, LA, NB, TS

•RADIO TRADE DIRECTORY•

MORRIS REGISTER CO., Council Bluffs, Iowa—A, GC
 MOTOROLA BOOSTER, Galvin Mfg. Corp.
 MUELLER ELECTRIC CO., 1583 E. 31 St., Cleveland, Ohio, "Clampipe"—GC
 THE MUTER COMPANY, 1255 South Michigan Ave., Chicago, Ill.—LE
 NOBLITT-SPARKS INDUSTRIES, INC., Columbus, Ind., "ARVIN"—A
 NOISE-MASTER, Cornish Wire Co., Inc.
 NORWEST RADIO LABS., Blaine Ave. & Hill St., Shelby, Mont., "Streamline", "Vertenna"—AWH, A
 PACENT ENGINEERING CORP., 79 Madison Ave., New York, N. Y., "Pacent"—AWH, NB, FM
 PHILCO RADIO & TELEVISION CORP., Tioga & C St., Philadelphia, Pa.—AWH, A, K, NB, BLA, GC, I, LE, LA, MAS, TS
 PHILMORE MANUFACTURING CO., 113 University Place, New York, N. Y.—GC, I, K, LE, NB
 PHILSON MFG. CO., INC., 156 Chambers St., New York, N. Y.—A, T
 PILOT RADIO CORP., 37-06 36th Street, Long Island City, N. Y.—AWH, FM
 PIONEER SPECIALTY COMPANY, 5100 St. Jean Ave., Detroit, Mich.—AV
 PREMAX PRODUCTS DIV., Chisholm-Ryder Co., Niagara Falls, N. Y., "Premax"—TS, Ground rods I
 PYREX, Corning Glass Works
 QUAM-NICHOLS CO., 33rd Place & Cottage Grove Ave., Chicago, Ill.—K, LA
 RADEX CORP., 1733 Milwaukee Ave., Chicago, Ill.—AWII, A, BLA, GC, I, K, LE, FM
 THE RADIART CORP., 13229 Shaw Ave., E. Cleveland, Ohio—AWH, A, I, LA, NB, T, TS
 RADIO ELECTRIC SERVICE CO., INC., N. W. Cor. 7th & Arch St., Phila., Pa.—AWH, A, BLA, GC, I, K, LE, LA, MAS, NB, O, TS, FM
 RADIO WIRE TELEVISION, INC., 100 Sixth Ave., New York, N. Y., "Lafayette"—AWH, A, K, MAS
 RADOLEK CO., 601 W. Randolph St., Chicago, Ill., "Radolek"—AWII, A, K, BLA, GC, I, LE, LA, MAS, NB, O, TS, FM
 RCA MFG. CO., Front & Cooper Sts., Camden, N. J., "RCA"—AWII, A, MAS, NB, BLA, GC, I, K, LE, LA, FM, O
 RIVARD MFG. CO., Toledo, Ohio—AWH, A, GC, I, K, LA
 MAURICE SCHWARTZ & SON, 710-712 Broadway, Schenectady, New York—AWH, A, BLA, GC, I, K, LE, LA, MAS, NB, O, TS, FM
 H. B. SHERMAN MFG. CO., 22 Barney St., Battle Creek, Mich.—GC
 SNYDER, INC., 813-23 Noble St., Philadelphia, Pa.—A, AWH, GC
 SPARKS-WITHINGTON CO., E. Ganson Ave., Jackson, Mich., "Sparton"—AWH
 SPARTON, Sparks-Withington Co.
 STAR MACHINE MFRS., INC., 1371 E. Bay Ave., Bronx, N. Y.—A
 STREAMLINE, Norwest Radio Labs.
 STROMBERG-CARLSON TELEPHONE MFG. CO., 100 Carlson Rd., Rochester, N. Y., "Stromberg-Carlson"—AWH
 SUN RADIO COMPANY, 212 Fulton Street, N. Y. C., N. Y.—AWH, A, BLA, GC, I, K, LE, LA, MAS, NB, O, TS, FM
 SUPERIOR TUBE CO., Norristown, Pa.—A
 TACO, Technical Appliance Corp.
 TECHNICAL APPLIANCE CORP., 17 E. 16th St., New York, N. Y., "Taco"—AWH, FM, K, MAS, NB, BLA, GC, I, LA, O, TFAC
 TELERADIO ENGINEERING CORP., 484 Broome St., New York, N. Y., "Teleradio"—BLA, K, LE, NB, FM
 TILTON ELECTRIC CORP., 15 E. 26th St., New York, N. Y., "Ex-Stat"—A, AWII, NB, FM
 VERTENNA, Norwest Radio Labs.

VERTI-FLEX ILLINOIS SEATING CO., 2138 North Racine Ave., Chicago, Ill.—AWH, MAS, NB, FM
 THE WARD PRODUCTS CORP., 1523 E. 45 St., Cleveland, Ohio, "Ward"—A, FM
 WILCOX ELECTRIC CO., INC., 4014 State Line, Kansas City, Kans.—T
 WINCHARGER CORPORATION, Sioux City, Iowa—TS
 WIRT COMPANY, 5221-27 Greene St., Phila., Pa.—LA
 YAXLEY, P. R. Mallory & Co., Inc.

AUTOMATIC TUNERS & PARTS

Inductance trimmer units ITU
 Mechanical selectors MS
 Pushbutton knobs PK
 Pushbutton motor operated units (complete) PMU
 Pushbutton trimmer units (complete) PTU
 Remote controls RC
 Station name cards SC
 Pushbutton switches PS
 Temperature compens. cond. TCC
 Trimmer condenser units TCU
 Tuning motors TM
 Rombic antennas, resistors RAR
 Pushbutton identification tabs PIT

ADVANCE ELECTRIC COMPANY, 1260 W. 2nd St., Los Angeles, Calif.—RC
 AEROVOX CORP., New Bedford, Mass.—TCU
 ALADDIN RADIO INDUSTRIES, INC., 468 W. Superior St., Chicago, Ill.—ITU
 ALDEN PRODUCTS CO., 715 Center St., Brockton, Mass.—PK
 ALLIANCE MFG. CO., Alliance, Ohio—TM
 ALLIED RADIO CORPORATION, 833 W. Jackson Blvd., Chicago, Ill.—ITU, MS, PK, PMU, PTU, PS, RC, TCC, TCU, TM
 AMERICAN EMBLEM CO., INC., P. O. 116-J, Utica, N. Y.—MS, SC
 AMERICAN RADIO HARDWARE CO., 476 Broadway, New York, N. Y., "Arhco"—PK
 AMERICAN STEEL PACKAGE CO., Squire Ave., Defiance, Ohio, "Defiance"—MS
 ANSLEY RADIO CORPORATION, 4377 Bronx Blvd., New York, N. Y.—RC
 ARHCO, American Radio Hardware Co.
 AUTOMATIC WINDING CO., INC., 900 Passaic Ave., East Newark, N. J.—ITU, PTU, TCU
 BARKER & WILLIAMSON, Ardmore, Pa.—ITU, MS, PC, TCU
 BUD RADIO, INC., 5205 Cedar Ave., Cleveland, Ohio—PS, TCU
 CENTRALAB, 900 E. Keefe Ave., Milwaukee, Wis., "Centralab"—PS, TCC
 CONSOLIDATED WIRE & ASSOC. CORPS., Peoria & Harrison Sts., Chicago, Ill.—MS
 CROWE NAME PLATE & MFG. CO., 3701 Ravenswood Ave., Chicago, Ill., "Crowe"—MS, PK, SC
 HARRY DAVIES MOLDING CO., 1428 N. Wells St., Chicago, Ill.—PK
 DEFIANCE, American Steel Package Co.
 D-X RADIO PRODUCTS CO., 1575 Milwaukee Ave., Chicago, Ill.—ITU, TCU
 ERIE RESISTOR CORP., 644 West 12th St., Erie, Pa.—ITU, PK, TCC, TCU
 FISCHER DISTRIBUTING CORP., 222 Fulton Street, N. Y., N. Y.—ITU, MS, PK, PMU, PS, RC, TCC, TCU, TM, PTU
 EMPIRE NOTION CO., 105 East 29th St., New York, N. Y.—PK
 GEMLIT, Gemloid Corp.
 GENERAL CEMENT MFG. CO., 919 Taylor Ave., Rockford, Ill.—SC
 GENERAL CERAMICS CO., Plant No. 3, Keasbey, N. J.—TCU (basis only)
 GENERAL INSTRUMENT CORP., 829 Newark Ave., Elizabeth, N. J.—MS

GENERAL MFG. CO., 1255 S. Michigan Ave., Chicago, Ill.—ITU
 GENERAL WINDING CO., 254 W. 31 St., New York, N. Y., "Gen-Win"—ITU, PMU, PTU, TCU, TM
 GEN-WIN, General Winding Co.
 GORDON SPECIALTIES CO., 1104 So. Wash Ave., Chicago, Ill.—RC
 CARL GORR PRINTING CO., INC., 2615 N. Ashland Ave., Chicago, Ill.—PIT
 GUARDIAN ELECTRIC MFG. CO., 1621 W. Walnut St., Chicago, Ill.—RC
 E. I. GUTHMAN & CO., INC., 400 S. Peoria St., Chicago, Ill., "Guthman"—ITU, PTU, TCU
 HAMMARLUND MFG. CO., INC., 424 W. 33 St., New York, N. Y.—TCU
 HARRISON RADIO CO., 12 West Broadway, New York, N. Y.—TCU
 HEGELER ZINC CO., P.O. Box 599, Danville, Ill.—ITU
 ICA, Insuline Corp. of America.
 INSULINE CORP. OF AMERICA, 30-30 Northern Blvd., Long Island City, N. Y., "ICA"—TCU, PK
 KURZ-KASCH, INC., 1421 S. Broadway, Dayton, Ohio.—PK
 LAFAYETTE RADIO CORP., 100 6th Ave., N. Y., N. Y.—ITU, MS, PK, PTU, PS, RC, TCC, TCU
 MAJESTIC RADIO & TELEVISION CORPORATION, 2600 West 50th St., Chicago, Ill.—ITU
 P. R. MALLORY & CO., INC., 3029 E. Washington St., Indianapolis, Ind., "Yaxley", "Mallory"—PS
 MEISSNER MFG. CO., 7th & Belmont, Mt. Carmel, Ill., "Meissner"—PTU, PS, TCU
 JAMES MILLEN MFG. CO., INC., 150 Exchange St., Malden, Mass.—TCU, TCC
 MONTGOMERY WARD & CO., 619 West Chicago Ave., Chicago, Ill.—TCU
 THE MUTER CO., 1255 South Michigan Ave., Chicago, Ill., "Muter"—PS, TCC, TCU
 OAK MFG. CO., 1260 Clybourn Ave., Chicago, Ill., "Oak"—MS, PS, PMU, PTU
 PACENT ENGINEERING CORP., 79 Madison Ave., New York, N. Y.—RC
 PHILCO RADIO & TELEVISION CORP., Tioga & C Streets, Philadelphia, Pa.—ITU, MS, PK, PMU, PTU, PS, RC, TCC, TCU
 PIONEER GEN-E-MOTOR CORP., 466 W. Superior St., Chicago, Ill.—TM
 RADIO ELECTRIC SERVICE CO., INC., N. W. Cor. 7th & Arch St., Phila., Pa.—ITU, MS, PK, PMU, PTU, PS, PC, TCC, TCU, TM
 RADIO KNOB CO., 43 East Ohio Street, Chicago, Ill.—PK
 RADOLEK COMPANY, 601 W. Randolph St., Chicago, Ill.—ITU, MS, PK, PMU, PS, TCU, PTU
 RCA MANUFACTURING CO., INC., Camden, N. J.—PTU, RC, TCC, TCU
 THE RICHARDSON COMPANY, 27th & Lake Sts., Melrose Park, Ill.—PK
 MAURICE SCHWARTZ & SON, 710-712 Broadway, Schenectady, New York—ITU, MS, PK, PMU, PTU, PS, PC, TCC, TCU, TM
 F. W. SICKLES CO., P.O. Box 920, Springfield, Mass.—ITU, PTU, TCU
 SORENG MANEGOLD CO., 1901 Clybourn Ave., Chicago, Ill.—PS
 SPARKS-WITHINGTON CO., E. Ganson Ave., Jackson, Mich., "Sparton"—PTU
 SPARTON, Sparks-Withington Co.
 SPRAGUE PRODUCTS COMPANY, North Adams, Mass.—PMU, PTU
 STACKPOLE CARBON CO., Tannery St., St. Marys, Pa., "Stackpole"—PS
 F. W. STEWART MFG. CORP., 340 W. Huron St., Chicago, Ill., "Stewart"—PMU, PS
 SUN RADIO COMPANY, 212 Fulton Street, N. Y., N. Y.—ITU, MS, UK, PMU, PTU, PS, RC, TCC, TCU, TM

TELERADIO ENGINEERING CORP., 484
Broome St., New York, N. Y., "Teleradio"
—ITU, PTU, TCC, TCU, RC
YAXLEY, P. R. Mallory & Co.

AUTO RADIO CONTROLS

Cable replacement tools **CRT**
Control units (complete) **CU**
Control heads **CH**
Fittings **F**
Flexible shafts **FS**

ALDEN PRODUCTS CO., 715 Center St.,
Brockton, Mass., "Alden"—**F**

ALLIED RADIO CORP., 833 W. Jackson
Blvd., Chicago, Ill.—**CRT, CU, CH, F, FS**

AMERICAN RADIO HARDWARE CO., 476
Broadway, New York, N. Y., "Arhco"—
CRT, F

ARHCO, American Radio Hardware Co.
ARVIN, Noblitt-Sparks Industries, Inc.
BUD RADIO, INC., 5205 Cedar Ave., Cleve-
land, Ohio—**FS**

CROWE NAME PLATE & MFG. CO., 3701
Ravenswood Ave., Chicago, Ill., "Crowe"
—**CU, CH, F, FS**

DELCO, United Motors Service
DUAL REMOTE CONTROL CO., 31776 W.
Warren St., Wayne, Mich., "Ducon"—**CU,**
CH, F, FS

DUCON, Dual Remote Control Co.

ERIE RESISTOR CORP., 644 W. 12th St.,
Erie, Pa.—**F**

FISCHER DISTRIBUTING CORP., 222
Fulton Street, N. Y., N. Y.—**CRT, CU,**
CH, F, FS

GALVIN MFG. CORP., 4545 Augusta Blvd.,
Chicago, Ill., "Motorola"—**CU, CH, F, FS**

GEMLIT, Gemloid Corp.

GEMLOID CORP., 79-10 Albion Ave., Elm-
hurst, L. I., "Gemloid," "Gemlite"—**F**

ICA, Insuline Corp. of America

INSULINE CORP. OF AMERICA, 30-30
Northern Blvd., Long Island City, N. Y.,
"ICA"—**FS**

J. F. D. MFG. CO., 4111 Ft. Hamilton Pkwy.,
Brooklyn, N. Y., "JFD"—**CRT, FS, F**

LAFAYETTE RADIO CORP., 100 6th Ave.,
N. Y., N. Y.—**CRT, CU, CH, F, FS**

P. R. MALLORY & CO., INC., 3029 E. Wash-
ington St., Indianapolis, Ind.—**FS**

MOTOROLA, Galvin Mfg. Corp.

NOBLITT-SPARKS INDUSTRIES, INC.,
Columbus, Ind., "Arvin"—**CU, FS**

PHILCO RADIO & TELEVISION CORP.,
Tioga & C Sts., Philadelphia, Pa.—**CU,**
CH, FS, F

RADIO ELECTRIC SERVICE CO., INC.,
N. W. Cor. 7th & Arch St., Phila., Pa.—
CRT, CU, CH, F, FS

RADOLEK COMPANY, 601 W. Randolph
St., Chicago, Ill.—**CRT, CU, CH, F, FS**

MAURICE SCHWARTZ & SON, 710-712
Broadway, Schenectady, New York—**CRT,**
CU, CH, F, FS

STAR MACHINES MFRS., INC., 1371 E.
Bay Ave., Bronx, N. Y.—**CRT, CU, CH,**
F, FS

F. W. STEWART MFG. CORP., 340 W.
Huron St., Chicago, Ill., "Stewart"—**CRT,**
CU, CH, F, FS

SUN RADIO COMPANY, 212 Fulton Street,
N. Y., N. Y.—**CRT, CU, CH, F, FS**

UNITED MOTORS SERVICE, 3044 W.
Grand Blvd., Detroit, Mich., "Delco"—**CU**

BATTERY CHARGERS, ELIMINATORS & RECTIFIERS

Battery-charging tubes **BT**
Battery eliminators **BE**
Gas-engine chargers **GC**
Gas-filled tubes **GT**
Metallic rectifiers **MR**
Mercury arc **MA**
Powerline chargers (home) **PCH**
Powerline chargers (service station) **PCS**
Power units, complete **PU**

Vacuum tubes (receiving excluded) . **VT**
Wind-driven chargers **WC**
Electric rectifiers **ER**
Power packs for portables **PP**

ACA, Amplifier Co. of America

AIRPLANE & MARINE DIRECTION
FINDER CORP., Clearfield, Pa.—PU

ALLEN ELECTRIC & EQUIPMENT CO.,
2101-2117 North Pitcher St., Kalamazoo,
Mich.—**PCS, ER**

ALLIED RADIO CORP., 833 W. Jackson
Blvd., Chicago, Ill.—**GC, PCH, PSC, WC**

AMERICAN COMMUNICATIONS CORP.,
123 Liberty St., New York, N. Y.—**GC,**
MR, PU

AMERICAN TELEVISION & RADIO
CORP., 300 E. 4th St., St. Paul, Minn.,
"ATR"—**BE, MR, PU**

AMPLIFIER CO. OF AMERICA, 17 W.
20th St., New York, N. Y., "ACA"—**PU**

VICTOR J. ANDREW, 6429 S. Lavergne
Ave., Chicago, Ill.—**PU**

ARLAB, Arlavox Mfg. Co.

ATR, American Television & Radio Corp.

AUTO RADIO FILTERPAC, The Benwood
Linze Co.

AUTOMATIC ELECTRICAL DEVICES,
324 E. Third St., Cincinnati, Ohio—**PCH**

AUDIO DEVICES, INC., 1600 Broadway,
New York, N. Y., "Audio" 1 phase 110v.
to 3 phase 220v. converter

BEE ENGINEERING CO., 7665 Grand Riv-
er Ave., Detroit, Mich.—**PU**

THE BENWOOD LINZE CO., 1838 Wash-
ington Ave., St. Louis, Mo., "B-L," "Auto
Radio Filterpac"—**PCH, PCS**

B-L, The Benwood Linze Co.

CINEMA ENGINEERING CO., 1508 S.
Verdugo Ave., Burbank, Calif., "Cinema"
—**PU**

COLLINS RADIO CO., 2920 First Ave.,
Cedar Rapids, Ia.—**PU, VT**

DELCO, United Motors Service

DE VRY CORP., 1111 Armitage Ave., Chi-
cago, Ill.—**BT, GT, MA, PU**

ECCO HIGH FREQUENCY CORP., 120 W.
20th St., New York, N. Y.—**PU**

EICOR, INC., 515 S. Laflin St., Chicago,
Ill.—**GC, WC**

ELECTRICAL PRODUCTS CO., 6535 Rus-
sell St., Detroit, Mich.—**MR**

ELECTRONIC LABORATORIES, INC.,
122 W. New York St., Indianapolis, Ind.
—**PU**

ELECTRONIC PRODUCTS CO., St.
Charles, Ill.—**PU**

ELECTRO PRODUCTS LABORATORIES,
549 W. Randolph St., Chicago, Ill.—**BE,**
PU

FANSTEEL METALLURGICAL CORP.,
46 W. 22nd St., N. Chicago, Ill.—**MR**

FERRANTI ELECTRIC, INC., 30 Rocke-
feller Plaza, New York, N. Y.—**PU**

FERRIS INSTRUMENT CORP., Boonton
Ave., Boonton, N. J., "Ferris"—**PU**

FISCHER DISTRIBUTING CORP., 222
Fulton St., N. Y. C., N. Y.—**GC, PCH,**
PCS, WC

GENERAL ELECTRIC CO., Schenectady,
N. Y.—**MA, PCH, PCS**

GENERAL ELECTRIC CO., West Lynn,
Mass.—**BT, GT, MR, VT**

GENERAL TRANSFORMER CORP., 1250
W. Van Buren St., Chicago, Ill., "Porta-
Power"—**BE, PU, PP**

THOMAS B. GIBBS & CO., 900 W. Lake
St., Chicago, Ill.—**PU**

ROBERT M. HADLEY CO., 709 E. 61st St.,
Los Angeles, Calif., & P.O. Box 456, New-
ark, Del., "Hadley"—**PU**

HARRISON RADIO CO., 12 West Broad-
way, New York, N. Y.—**GC, PCH**

INTERNATIONAL TRANSFORMER CO.,
17 W. 20th St., New York, N. Y.—**PU**

JANETTE MANUFACTURING COM-
PANY, 556-558 West Monroe St., Chicago,
Ill.—**GC**

KATO ENGINEERING COMPANY, INC.,
530 North Front Street, Mankato, Minn.—
GC

KELLOGG SWITCHBOARD & SUPPLY
CO., 6650 South Cicero Avenue, Chicago,
Ill.—**A, B, C, DC, FC**

LAFAYETTE RADIO CORPORATION, 100
6th Ave., N. Y. C., N. Y.—**GC, PCH, PCS,**
WC

LAUREHK RADIO MFG. CO., 3918 Mon-
roe Ave., Wayne, Michigan—**PCH**

THE LAUSON COMPANY, New Holstein,
Wisconsin—**GC**

MAJESTIC RADIO & TELEVISION CORP.,
2600 W. 50th St., Chicago, Ill.—**IF, RFRC,**
RF

P. R. MALLORY & CO., INC., 3029 W.
Washington St., Indianapolis, Ind., "Mal-
lory Dry Disc"—**PCH**

MIDCO MFG. & DIST. CO., INC., S. 13th
& Kentucky Ave., Sheboygan, Wis.—**GC**

MONTGOMERY WARD & CO., 619 W. Chi-
cago Ave., Chicago, Ill.—**GC, WC**

D. W. ONAN & SONS, 43 Royalston Ave.,
Minneapolis, Minn.—**GC**

PORTA-POWER, General Transformer
Corp.

PIONEER GEN-E-MOTOR CORP., 466 W.
Superior St., Chicago, Ill.—**GC**

THE RADIART CORP., 13229 Shaw Ave.,
E. Cleveland, Ohio—**PU**

RADIO ELECTRIC SERVICE CO., INC.,
N. W. Cor. 7th & Arch St., Phila., Pa.—
GC, WC

RADIO ENGINEERING LABS., INC., 35-
54 36th St., Long Island City, N. Y.—**PU**

RADIOTRON, RCA Mfg. Co., Inc.

RADIO RECEPTOR CO., INC., 251 W. 19th
St., New York, N. Y., "Radio Receptor"—
PU

RADOLEK COMPANY, 601 W. Randolph
St., Chicago, Ill.—**GC, PCH, PCS, WC**

RAYTHEON MFG. CO., 190 Willow St.,
Waltham, Mass., "Rectifilter"—**PU**

RCA MFG. CO., INC., Front & Cooper Sts.,
Camden, N. J., "RCA," "Radiotron"—**BT,**
GT, PU, VT

RECTIFILTER, Raytheon Mfg. Co.

MAURICE SCHWARTZ & SON, 710-712
Broadway, Schenectady, New York—**GC,**
PCH, PCS, WC

SKAGGS TRANSFORMER CO., 5894
Broadway, Los Angeles, Calif.—**PU**

MAXWELL SMITH CO., 1027 N. Highland
Ave., Hollywood, Calif.—**PU**

STANCOR, Standard Transformer Corp.

STANDARD TRANSFORMER CORP., 1500
N. Halsted St., Chicago, Ill., "Stancor"—
MR, PU

SUN RADIO COMPANY, 212 Fulton Street,
N. Y. C., N. Y.—**GC, PCH, WC**

TALK-A-PHONE MFG. CO., 1847 S. Mil-
lard Ave., Chicago, Ill.—**PU**

TECHNICAL PRODUCTS INTERNA-
TIONAL, 135 Liberty Street, New York,
N. Y.—**GC, PCH, PCS, WC**

UNITED CINEPHONE CORP., 43-37 33rd
St., Long Island City, N. Y.—**MA, PU,**
VT

UNITED MOTORS SERVICE, 3044 W.
Grand Blvd., Detroit, Mich., "Delco"—**PU**

UNITED TELEPHONE CORP., 150 Varick
St., New York, N. Y.—**PU**

UNITED TRANSFORMER CORP., 150
Varick St., New York, N. Y.—**PCH**

WARD LEONARD ELECTRIC CO., 31
South Street, Mount Vernon, N. Y.—**PCS**

EARL WEBBER CO., 4348 West Roosevelt
Road, Chicago, Ill.—**PCS**

WESTERN ELECTRIC CO., 300 Central
Ave., Kearny, N. J.—**GT, VT**

WESTINGHOUSE ELECTRIC & MFG.
CO., E. Pittsburgh, Pa.—MA

WILCOX ELECTRIC CO., INC., 4014 State
Line, Kansas City, Kans.—**PU**

RADIO TRADE DIRECTORY

WILLARD STORAGE BATTERY CO., 246 E. 131st St., Cleveland, Ohio, "Willard"—BT
WINCHARGER CORPORATION, Sioux City, Iowa—GC, WC

BATTERIES, DRY & WET

"A" blocks	A
"B"	B
"C"	C
Bias cells	BC
Dry cells	DC
Flashlight cells	FC
Portable batteries	PB
Storage batteries	SB
Miniature portable	MP

AIR CELL, National Carbon Co., Inc.
AIRLINE, Montgomery Ward & Co.
ALLIED BURNS CO., 2125 Wyndhurst Ave., Toledo, Ohio—Wearable hearing aid packs
ALLIED RADIO CORP., 833 W. Jackson Blvd., Chicago, Ill., "Knight"—A, B, C, DC, FC, SB, MP
BOND ELECTRIC CORP., 146 Munson St., New Haven, Conn., "Bond"—A, B, C, DC, FC, PB
BRIGHT STAR BATTERY CO., 200 Crooks Ave., Clifton, N. J., "Unneed-it Eclipse"—A, B, C, DC, FC, PB
BURGESS BATTERY CO., Freeport, Ill., "Burgess"—A, B, C, DC, FC, PB
CHARGIT CORPORATION, Anderson, Indiana—FC, SB
DE VRY CORP., 1111 Armitage Ave., Chicago, Ill.—SB
ECLIPSE, Bright Star Battery Co.
ELECTRIC STORAGE BATTERY CO., Allegheny Ave. and 19th St., Philadelphia, Pa., "Exide"—SB
ELECTRO PRODUCTS LABORATORIES, 549 W. Randolph St., Chicago, Ill.—C
EVEREADY, National Carbon Co.
EXIDE, Electric Storage Battery Co.
FISCHER DISTRIBUTING CORP., 222 Fulton Street, N. Y., N. Y.—A, B, C, DC, FC, PB
GELARDIN, INC., 21-29 Washington Street, Brooklyn, N. Y.—A, B, C, DC, FC, PB
GENERAL DRY BATTERIES, INC., 13100 Athens Ave., Cleveland, Ohio and Dubuque, Iowa—B, C, FC, PB, A, DC
GLOBE PHONE MANUFACTURING CORP., Reading, Mass.—A, B
GLOBE-UNION, INC., 900 E. Keefe Ave., Milwaukee, Wis., "Globe-Union"—SB
GOLDENTONE RADIO CO., 15123 Warren Ave., Dearborn, Mich.—A, B, PB
HARRISON RADIO CO., 12 West Broadway, New York, N. Y.—A, B, C, DC, FC, SB, MP
HERBERT H. HORN, 1201 So. Olive St., Los Angeles, Calif.—A, B, C, DC, FC, MP
IDEAL COMMUTATOR DRESSER CO., Sycamore, Illinois—FC
JUMBO BATTERY MFRS., Ellsworth, Iowa, "Jumbo"—SB
KNIGHT, Allied Radio Corp.
LAFAYETTE RADIO CORP., 100 6th Ave., N. Y., N. Y.—A, B, C, DC, FC, SB, MP
LAYER-BILT, National Carbon Co., Inc.
M. & G. HEARING AIDS COMPANY, 30 North Michigan Avenue, Chicago, Ill.—A, B, C, DC, PC, MP
M & H SPORTING GOODS CO., 512 Market St., Phila., Pa.—A, B, C, DC, FC, MP
MINI-MAX, National Carbon Co., Inc.
MONARK BATTERY CO., INC., 4556 W. Grand Ave., Chicago, Ill., "Monark"—SB
MONTGOMERY WARD & CO., 619 W. Chicago Ave., Chicago, Ill., "Airline"—A, B, C, DC, FC, PB, SB, MP
NATIONAL CARBON CO., INC., 30 E. 42nd St., New York, N. Y., "Air Cell," "Eveready," "Layer-Bilt," "Mini-Max"—A, B, C, DC, FC, PB

NATIONAL UNION RADIO CORP., 57 State St., Newark, N. J., "National Union"—PB
PHILCO RADIO & TELEVISION CORP., Tioga and C Sts., Philadelphia, Pa.—A, B, C, DC, FC, PB, SB
RADIO ELECTRIC SERVICE CO., INC., N. W. Cor 7th & Arch St., Phila., Pa.—A, B, C, DC, FC, SB, MP
RADOLEK COMPANY, 601 W. Randolph St., Chicago, Ill.—A, B, C, DC, FC, SB, MP
RAY-O-VAC CO., 2317 Winnebago St., Madison, Wis., "Ray-O-Vac"—A, B, C, DC, FC, MP
MAURICE SCHWARTZ & SON, 710-712 Broadway, Schenectady, New York—A, B, C, DC, FC, MP
SENTINEL RADIO CORPORATION, 2020 Ridge Ave., Evanston, Ill.—A, B, PB
SILLCOX RADIO & TELEVISION CORP., 60 Wall Tower, New York, N. Y.—A, B, C, DC, FC, PB, SB
STROMBERG-CARLSON TELEPHONE MFG. CO., 100 Carlson Rd., Rochester, N. Y., "Stromberg-Carlson"—SB, DC
SUN RADIO COMPANY, 212 Fulton Street, N. Y., N. Y.—A, B, C, DC, FC, MP
UNEEED-IT, Bright Star Battery Co.
UNITED STATES ELECTRIC MFG. CORP., 222 W. 14th St., New York, N. Y., "Usalight"—DC, FC, PB
UNIVERSAL BATTERY CO., 3410 S. La-Salle St., Chicago, Ill., "Universal"—SB
U S L BATTERY CORP., Niagara Falls, N. Y., "U-S-L"—SB
USALIGHT, United States Electric Mfg. Corp.
WILLARD STORAGE BATTERY CO., 246 E. 131st St., Cleveland, Ohio, "Willard"—A, B, C, DC, FC, PB, SB
WINCHARGER CORPORATION, Sioux City, Iowa—SB
WIND-IMPELLER ELECTRIC WORKS, Ellsworth, Iowa—SB

CABINETS

Console (wood)	C
Metal	M
Plastic	P
Table (wood)	T
Cabinet refinishing kits & materials	

ALLIED RADIO CORP., 833 W. Jackson Blvd., Chicago, Ill.—C, M, P, T
ANSLEY RADIO CORPORATION, 4377 Bronx Blvd., New York, N. Y.—C, T
ATLAS SOUND CORPORATION, 1447-39th St., Brooklyn, N. Y.—C, M, T
AUBURN BUTTON WORKS, INC., Auburn, New York—P
BOONTON MOLDING CO., 326 Myrtle Ave., Boonton, New Jersey—P
BUD RADIO, INC., 5205 Cedar Ave., Cleveland, Ohio—M
CASTLEWOOD MANUFACTURING CO., 12th & Burnett Sts., Louisville, Ky.—C, T
THE CASWELL-RUNYAN CO., Huntington, Indiana—C
CHURCHILL CABINET COMPANY, 2119 Churchill Street, Chicago, Ill.—C, T
GENERAL ELECTRIC CO., Schenectady, N. Y., Bridgeport, Conn.—M, P
L. F. GRAMMES & SONS, INC., 364 Union St., Allentown, Pa.—M
ROBERT M. HADLEY COMPANY, 709-11 East Sixth-first Street, Los Angeles, Calif.—M
HAMMOND MANUFACTURING CO., Guelph, Ontario, Canada—M
HARRISON RADIO CO., 12 West Broadway, New York, N. Y.—C, M, T
ILLINOIS CABINET CO., 2525 Eleventh St., Rockford, Ill.—C, T
KARP METAL PRODUCTS CO., INC., 129-30th Street, Brooklyn, N. Y.—M
LAFAYETTE RADIO CORP., 100 6th Ave., N. Y., N. Y.—C, M, P, T

LE FEBURE CORPORATION, 716 Oakland Road, Cedar Rapids, Iowa—M
THE LINCROPHONE CO., INC., 1661 Howard Ave., Utica, N. Y.—C
MAJESTIC RADIO & TELEVISION CORPORATION, 2600 W. 50th St., Chicago, Ill.—T
T. R. McELROY, 100 Brookline Ave., Boston, Mass.—P
MEISSNER MANUFACTURING CO., Mt. Carmel, Ill.—C, M
MIDWEST RADIO CORP., 909 Broadway, Cincinnati, Ohio—C, T
JAMES MILLEN MFG. CO., 150 Exchange St., Malden, Mass.
MONTGOMERY WARD & CO., 619 W. Chicago Ave., Chicago, Ill.—M
NATIONAL COMPANY, INC., 61 Sherman Street, Malden, Mass.—M
PACENT ENGINEERING CORPORATION, 79 Madison Ave., New York, N. Y.—C, T
PAR-METAL PRODUCTS CORP., 32-62 49th Street, Long Island City, N. Y.—M
PAUL & BEEKMAN, 4250 Wissahickon Ave., Philadelphia, Pa.—M
PHILCO RADIO & TELEVISION CORP., Tioga & C Sts., Phila., Pa.—C, M, P, T
RADOLEK COMPANY, 601 W. Randolph St., Chicago, Ill.—C, M, P, T
RCA MFG. CO., INC., Camden, N. J.—C, M, P, T
THE RICHARDSON COMPANY, 27th & Lake Sts., Melrose Park, Ill.—P
ROCK-OLA MANUFACTURING CORPORATION, 800 N. Kedzie Avenue, Chicago, Ill.—C, T
WALTER L. SCHOTT CO., 5264 W. Pico Blvd., Los Angeles, Calif.—CK
MAURICE SCHWARTZ & SON, 710-712 Broadway, Schenectady, New York—C, M, P, T
MARK SIMPSON DIST. CO., INC., 16 Hudson Street, New York, N. Y.—C
STEGER FURNITURE MFG. COMPANY, 34th Street & C. & E. I. R. R., Steger, Ill.—C, T
STEVENS WALDEN, INC., 475 Shrewsbury Street, Worcester, Mass.—M
SUN RADIO COMPANY, 212 Fulton Street, N. Y., N. Y.—C, M
UNION STEEL CHEST CORP., 54 Church St., Le Roy, New York—M
THE VEGA CO., 155 Columbus Ave., Boston, Mass.—C
WELLS-GARDNER & CO., 2701 N. Kildare Ave., Chicago, Ill.—C, T

COILS & I.F. TRANSFORMERS

Coil forms	F
Coil-winding equipment	CE
I.F. coils	IF
Iron cores	IC
R.F. chokes (receiving)	RFCR
R.F. chokes (transmitting)	RFCT
R.F. coils (receiving)	RF
Transmitting coils	TC

ALADDIN RADIO INDUSTRIES, INC., 468 W. Superior St., Chicago, Ill., "Aladdin"—IF, RFCR, P, RF, TC
ALDEN PRODUCTS CO., 715 Center St., Brockton, Mass., "Na-Ald"—F, RF
ALLIED RADIO CORP., 833 W. Jackson Blvd., Chicago, Ill., "Knight"—IF, RFCR, RF, F, CE, TC
AMERICAN COMMUNICATIONS CORP., 123 Liberty St., New York, N. Y.—TC
AMERICAN LAVA CORP., Cherokee Blvd. & Manufacturers Rd., Chattanooga, Tenn.—F
AMERICAN PHENOLIC CORP., 1250 Van Buren St., Chicago, Ill., "Amphenol"—F (polystyrene)

AMERICAN TELEVISION CORPORATION, 130 West 56th Street, New York, N. Y.—F
 AMPHENOL, American Phenolic Corp.
 AUBURN BUTTON WORKS, INC., Auburn, New York—F
 BARKER & WILLIAMSON, Ardmore, Pa.—F, T
 BOND PRODUCTS CO., 13139 Hamilton Ave., Detroit, Michigan—F, RFCR
 BUD RADIO, INC., 5250 Cedar Ave., Cleveland, Ohio—F, RFCR, TC
 CARRON MANUFACTURING CO., 415 So. Aberdeen Street, Chicago, Ill.—F, IF, RFCR, FR, TC
 DELTA RADIO CORPORATION, 115 Worth St., New York, N. Y.—IF, RFCR, RF, TC
 DOOLITTLE & FALKNER, INC., 7421 Loomis Blvd., Chicago, Ill.—T
 D-X RADIO PRODUCTS CO., 1575 Milwaukee Ave., Chicago, Ill.—F, IF, RFCR, RFCT, TC
 EISLER ENGINEERING CO., 750 So. 13th St., Newark, N. J.—CE
 ELECTRONIC APPLICATIONS, Brunswick, Maine—IF, RFCR, RF, TC
 JOHN E. FAST & CO., 3123 N. Pulaski Ave., Chicago, Ill.—RFCR
 GENERAL CERAMICS CO., 30 Rockefeller Plaza, New York, N. Y.—F
 GENERAL CERAMICS CO., PLANT No. 3, Keasbey, N. J.—F (ceramic only)
 GENERAL MFG. CO., 1255 S. Michigan Ave., Chicago, Ill., "Gen-Ral"—F, CE, IF, RFCR, RF, TC
 GENERAL WINDING CO., 254 W. 31st St., New York, N. Y., "Gen-Win"—F, CE, IF, RFCR, RF, TC
 GEN-RAL, General Mfg. Co.
 GEN-WIN, General Winding Co.
 E. I. GUTHMAN & CO., INC., 400 S. Peoria St., Chicago, Ill., "GUTHman"—CE, IF, RFCR, RF
 HAMMARLUND MFG. CO., INC., 424 W. 33rd St., New York, N. Y.—F, IF, RFCR, RF, T
 HARRISON RADIO CO., 12 West Broadway, New York, N. Y.—IF, RFCR, RF, TC
 HERBERT H. HORN, 1201 So. Olive St., Los Angeles, Calif.—IF, RFCR, RF
 ICA, Insuline Corp. of America
 INSULINE CORP. OF AMERICA, 30-30 Northern Blvd., Long Island City, N. Y., "ICA"—F, RFCR, RF, TC
 ISOLANTITE, INC., 233 Broadway, New York, N. Y., "Isolantite"—F
 E. F. JOHNSON, Waseca, Minn., "Johnson"—TC, RF
 KNIGHT, Allied Radio Corp.
 LAFAYETTE RADIO CORPORATION, 100 6th Ave., N. Y. C., N. Y.—F, CE, IF, RFCR, RF, TC
 M & H SPORTING GOODS CO., 512 Market St., Phila., Pa.—IF, RFCR, RF, TC
 P. R. MALLORY & CO., INC., 3029 E. Washington St., Indianapolis, Ind., "Mallory"—RFCR
 MEISSNER MFG. CO., 7th & Belmont Sts., Mt. Carmel, Ill., "Meissner"—F, CE, IF, RFCR, RF, TC
 MILES REPRODUCER CO., INC., 812 Broadway, New York, N. Y.—F, CE, IF, RFCR, RF, TC
 JAMES MILLEN MFG. CO., INC., 150 Exchange St., Malden, Mass.—F, IF, RFCR, RF, TC
 J. W. MILLER CO., 5917 S. Main St., Los Angeles, Calif., "Miller"—IF, RFCR, FR, (high fidelity)
 MONTGOMERY WARD & CO., 619 W. Chicago Ave., Chicago, Ill.—F, RFCR, RF, TC
 THE MUTER CO., 1255 South Michigan Ave., Chicago, Ill., "Muter"—IF, RFCR, RF
 NA-ALD, Alden Products Co.

NATIONAL COMPANY, 61 Sherman St., Malden, Mass., "National," "N-C"—F, IF, RFCR, RF, TC
 N-C, National Co.
 PACENT ENGINEERING CORP., 79 Madison Ave., New York, N. Y., "Pacent"—High Fidelity RF tuner
 PARAMOUNT PAPER TUBE CO., 801 Glasgow Ave., Ft. Wayne, Ind.—F
 PHILCO RADIO & TELEVISION CORP., Tioga & C Sts., Philadelphia, Pa.—IF, RFCR, RF
 PREMIER CRYSTAL LABS., INC., 55 Park Row, New York, N. Y., "Premier"—TC
 RADEX CORP., 1733 Milwaukee Ave., Chicago, Ill.—F, IF, RFCR, RF, TC
 RADIO ELECTRIC SERVICE CO., INC., N. W. Cor. 7th & Arch St., Phila. Pa.—F, CE, IF, RFCF, RF, TC
 RADIO ENGINEERING LABS., INC., 35-54 36th Street, Long Island City, N. Y. C., N. Y.—TC
 RADOLEK COMPANY, 601 W. Randolph St., Chicago, Ill.—F, CE, IF, RFCR, RF, TC
 RCA MANUFACTURING CO., INC., Camden, N. J.—IF, RFCR, RF
 MAURICE SCHWARTZ & SON, 710-712 Broadway, Schenectady, New York—F, CE, TF, RFCR, RF, TC
 F. W. SICKLES CO., P. O. Box 920, Springfield, Mass.—IF, RFCR, RF, TC
 STACKPOLE CARBON CO., Tannery St., St. Marys, Pa., "Stackpole"—IC
 SUN RADIO COMPANY, 212 Fulton Street, N. Y., N. Y.—F, CE, IF, RFCR, RF, TC
 SYNTHANE CORP., Highland Ave., Oaks, Pa.—F
 TAYLOR FIBRE CO., Norristown, Pa.—F
 TELERADIO ENGINEERING CORP., 484 Broome St., New York, N. Y., "Telerradio"—IF, RFCR, RF, TC, F, CE
 TRIUMPH MFG. CO., 4017 W. Lake St., Chicago, Ill.—IF, RFCR, RF, TC
 UNITED STATES TELEVISION MANUFACTURING CORP., 220 East 51st Street, New York, N. Y.—IF

CONDENSERS, FIXED

Ceramic	C
Compensating Condensers	CC
Electrolytic dry	ED
Electrolytic wet	EW
Industrial	I
Mica receiving	MR
Mica padding	MP
Paper (receiving)	PR
Polystyrene	P
Transmitting	T
Television condensers	TC
Power factor correction	PCF

AEROVOX CORPORATION, New Bedford, Mass.—ED, EW, I, MR, MP, PR, T, TC, PRC
 ALLIED RADIO CORPORATION, 833 W. Jackson Blvd., Chicago, Ill.—C, ED, EW, I, MR, MP, PR, T, TC
 AMERICAN CONDENSER CORP., 2508 S. Michigan Ave., Chicago, Ill.—ED, I, PR, T, TC
 VICTOR J. ANDREW, 6429 South Laverne Ave., Chicago, Ill.—T
 ATLAS CONDENSER PRODUCTS CO., 548 Westchester Ave., New York, N. Y.—ED, PR
 ATOMS, Sprague Products Co.
 AUTOMATIC WINDING CO., INC., 900 Passaic Ave., East Newark, N. J.—C, MR, T
 BOND PRODUCTS CO., 13139 Hamilton Ave., Detroit, Mich.—PR
 BUD RADIO, INC., 5205 Cedar Ave., Cleveland, Ohio—T
 ALLEN D. CARDWELL MFG. CORP., 81 Prospect St., Brooklyn, N. Y.—T (Air), I
 CENTRALAB, 900 E. Keefe Ave., Milwaukee, Wis.—C

CONDENSER CORP. OF AMERICA, 1000 Hamilton Blvd., South Plainfield, N. J.—ED, EW, I, MR, PR, T
 CONDENSER PRODUCTS, 1375 N. Branch St., Chicago, Ill.—ED, PR, P, TC, I, PFC
 CONSOLIDATED WIRE & ASSOC. CORPS., Peoria & Harrison Sts., Chicago, Ill.—ED, PR, T
 CONTINENTAL CARBON, INC., 13900 Lorain Ave., Cleveland, Ohio—I, PR, T, TC
 CORNELL-DUBILIER ELEC. CORP., 1000 Hamilton Blvd., South Plainfield, N. J.—ED, I, MR, PR, T
 COSMIC RADIO CORP., 699 E. 135th St., New York, N. Y., "Cosmic," "Megrite"—ED, PR
 TOBE DEUTSCHMANN CORPORATION, Washington Street, Canton, Mass.—CC, ED, EW, I, PR, T, TC
 DOMINO, Solar Mfg. Corp.
 DUMONT ELECTRIC CO., INC., 514 Broadway, New York, N. Y., "Du Mont"—ED, EW, I, MR, PR, T
 D-X RADIO PRODUCTS CO., 1575 Milwaukee Ave., Chicago, Ill.—C
 ECCO HIGH FREQUENCY CORP., 120 W. 20th St., New York, N. Y., "Ecco H.F."—T
 ELECTRO MOTIVE MFG. CO., INC., So. Park & John Sts., Willimantic, Conn.—MR
 ELMENCO, Electro Motive Mfg. Co., Inc.
 ERIE RESISTOR CORP., Erie, Pa.—C, MR, PM, TC
 EX-STAT, Tilton Electric Corp.
 J. E. FAST & CO., 3123 N. Pulaski Ave., Chicago, Ill.—I, PR, T, TC
 GENERAL ELECTRIC CO., 1 River Road, Schenectady, N. Y.—EW, I, T, TC
 GENERAL ELECTRIC CO., Pittsfield, Mass.—I, T
 GENERAL MFG. CO., 1255 S. Michigan Ave., Chicago, Ill.—C, MR, PR
 GENERAL RADIO CO., 30 State St., Cambridge, Mass., "G-R"—Precision M, Special
 G-H, Girard Hopkins
 GIRARD HOPKINS, 1437 23rd Ave., Oakland, Calif., "G-H"—ED, EW, I, PR, P, T
 G-R, General Radio Co.
 HAMMOND MANUFACTURING CO., Guelph, Ontario, Canada—T
 HARRISON RADIO CO., 12 West Broadway, New York, N. Y.—C, ED, EW, I, MR, MP, PR, T, TC
 HEINTZ & KAUFMAN, LTD., South San Francisco, Calif.—T (compressed gas filled)
 H K, Heintz & Kaufman, Ltd.
 HERBERT H. HORN, 1201 So. Olive St., Los Angeles, Calif.—ED, EW, MR, MP, PR
 H. R. S. PRODUCTS, 703 N. Cicero Ave., Chicago, Ill.—ED, I, PR, P, T
 ICA, Insuline Corp. of America
 ILLINOIS CONDENSER CO., 1160 N. Howe St., Chicago, Ill., "Illinois"—ED, I, PR
 INDUSTRIAL CONDENSER CORP., 4049 W. Diversey Ave., Chicago, Ill., "Industrial"—ED, I, PR, T, TC
 INSULINE CORP. OF AMERICA, 30-30 Northern Blvd., Long Island City, N. Y., "ICA"—T
 E. F. JOHNSON, Waseca, Minn., "Johnson"—T
 KODACAP, Micamold Radio Corp.
 LAFAYETTE RADIO CORPORATION, 100 6th Ave., N. Y. C., N. Y.—C, ED, EW, I, MR, MP, PR, T, TC
 LITTLE GIANT, Solar Mfg. Corp.
 M & H SPORTING GOODS CO., 512 Market St., Phila., Pa.—CC, ED, EW, I, MR, MP, PR, T, TC
 MAGNAVOX CO., 2131 Bueter Rd., Ft. Wayne, Ind., "Magnavox"—ED
 P. R. MALLORY & CO., INC., 3029 E. Washington St., Indianapolis, Ind., "Mallory"—ED, EW, I, MR, PR, T, C, PM, TC
 (Continued on following page)

Radio Design UNIVERSAL METER



21
RANGES
A.C. and D.C.
ONLY
\$9.95

Ready to Use

The serviceman's most important all-around meter. Measures AC and DC volts, DC milliamperes, decibels, resistance and output level. Uses 0-1 ms. meter with 1000 ohms per volt sensitivity; 1% tolerance shunts and multipliers. Rotary switch selects all ranges. Simple, convenient to use. Weighs but 1 1/4 lbs. Compact, 6 1/4" x 4 1/4" x 3 1/2". Complete with test leads and handsome oak-finished wood case. Its complete ranges are:

D.C. VOLTS: 0-10, 50, 250, 500, 2,500
A.C. VOLTS: 0-15, 150, 1,500
D.C. MILS: 0-1, 10, 100, 1,000
DECIBELS (Db): 18, 38, 58
OHMS: 0-5,000, 50,000, 500,000
OUTPUT: 0-15, 150, 1,500

WRITE FOR LITERATURE
ALLAN STUART

P. O. BOX 56 TEANECK, N. J.

JUST PUBLISHED AUTOMOBILE RADIO—

Principles & Practice
by B. Baker Bryant

See Page 230



OPERATES ON
110-VOLT, 60-CYCLE
A.C. LINE

WE SHIP ELECTRIC DRY
SHAVER THE SAME DAY
YOUR SUBSCRIPTION
ORDER IS RECEIVED.

CLIP COUPON—
AND MAIL!

Get This Electric Dry Shaver ABSOLUTELY FREE!

JUST THINK OF IT—you can get absolutely FREE, the useful DRY ELECTRIC SHAVER which is shown at the left. This ELECTRIC DRY SHAVER is sent to you by the publishers with a one-year subscription to RADIO-CRAFT.

Here Are the Features of The ELECTRIC DRY SHAVER

Constructed of metal with attractive red bronze finish. Scientifically constructed to give a perfectly clean shave. 5-foot rubber insulated cord and plug. Constructed to last for many years.

Operates from 110-volt, 60-cycle A.C. electric line. Carries a two-year manufacturer's guarantee. A fine quality, self-sharpening toilet necessity.

Send your subscription to RADIO-CRAFT for One Year (12 issues) and receive absolutely FREE one of these remarkable Electric Dry Shavers. New subscribers are accepted or you may extend your present subscription another twelve months. Mail your remittance of \$2.00 (plus 25c for shipping charges on Shaver) to the publishers. (Canada and foreign \$2.75.) You will receive your DRY ELECTRIC SHAVER immediately by return mail. Use coupon below to enter your subscription.

RADIO-CRAFT

20 Vesey Street, New York, N. Y.

RADIO-CRAFT, 20 Vesey Street, New York, N. Y.

Gentlemen: Enclosed find my remittance of \$2.00 for which enter my subscription to RADIO-CRAFT for one year (12 issues). Send me immediately FREE, ELECTRIC DRY SHAVER (Canada and foreign \$2.75). In U. S. add only 25c additional to cover shipping charges on Shaver.

New Subscriber Extend Present Subscription

Name

Address

City State

(Send remittance by check, money order or unused U.S. Postage Stamps. Register letter if you send cash or stamps.)

RADIO-CRAFT for OCTOBER, 1940

MEGRITE, Cosmic Radio Corp.
MEISSNER MANUFACTURING CO., Mt. Carmel, Ill.—MP
MICAMOLD RADIO CORP., 1087 Flushing Ave., Brooklyn, N. Y., "Kodacap"—ED, MR, PR, T, EW
JAMES MILLEN MFG. CO., INC., 150 Exchange St., Malden, Mass.—C, T
MIMS RADIO CO., P.O. Box 504, Texarkana, Ark.—I
MINICAP, Solar Mfg. Corp.
MONTGOMERY WARD & CO., 619 W. Chicago Ave., Chicago, Ill.—ED, EW, MR, MP, PR, T
MUTER CO., 1255 South Michigan Ave., Chicago, Ill., "Muter"—CC
PHILCO RADIO & TELEVISION CORP., Tioga & C Sts., Philadelphia, Pa.—ED, EW, MR, PR, C, I, TC, MP
THE POTTER CO., 1950 Sheridan Rd., North Chicago, Ill., "Potter"—ED, I, PR, T
RADIO ELECTRIC SERVICE CO., Inc., N. W. Cor. 7th & Arch St., Phila., Pa.—C, ED, EW, I, MR, MP, PR, T, TC
RADOLEK COMPANY, 601 W. Randolph St., Chicago, Ill.—E, ED, EW, I, MR, MP, PR, T, TC
RCA FARADON, RCA Mfg. Co., Inc.
RCA MFG. CO., INC., Front & Cooper Sts., Camden, N. J., "RCA" "RCA Faradon"—C, MR, PR, T, MP
SANGAMO ELECTRIC CO., Springfield, Ill., "Sangamo"—MR, T
MAURICE SCHWARTZ & SON, 710-712 Broadway, Schenectady, New York—C, ED, EW, I, MR, MP, PR, T, TC
SEALDTITE, Solar Mfg. Corp.
SEVISION MAGNETO ENG. CO., 379 Phillips Ave., Toledo, Ohio—PR

F. W. SICKLES CO., P.O. Box 920, Springfield, Mass., "Silver Cap"—MR (silvered mica)
SILVERCAP, F. W. Sickles Co.
SOLAR MFG. CORP., Bayonne, N. J., "Solar," "Domino," "Sealdtite," "Tom Thumb," "Transoil," "Transmica," "Minicap," "Little Giant"—ED, EW, I, MR, PR, P, T, C, TC
SPRAGUE PRODUCTS CO., N. Adams, Mass., "Sprague 600 Line," "Atoms"—ED, EW, I, MR, PR, T
STROMBERG-CARLSON TELEPHONE MFG. CO., 100 Carlson Rd., Rochester, N. Y.—PR
SUN RADIO COMPANY, 212 Fulton Street, N. Y., N. Y.—CC, ED, EW, I, MR, MP, PR, T, TC
TELERADIO ENGINEERING CORP., 484 Broome St., New York, N. Y., "Teleradio"—MR, C, MP, TC
TILTON ELECTRIC CORP., 15 E. 26th St., New York, N. Y., "Ex-Stat"—ED, EW, PR
TOM THUMB, Solar Mfg. Corp.
TRANSMICA, Solar Mfg., Corp.
TRANSOIL, Solar Mfg. Corp.

SHOP NOTES—KINKS —CIRCUITS

ELECTRIFIES 2-MEGOHM RANGE

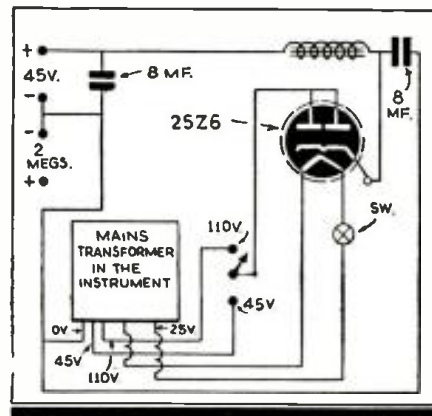

A Supreme "Standard Diagnometer" required a special 45-V. battery for the 2-megohm range of the ohmmeter. The necessity of the battery was eliminated by adding a rectifier tube as the diagram shows. It gives very efficient service and the Serviceman can use the 45 V. or 110 V. D.C. thus produced for his service oscillator, if it is a battery-operated one to test battery sets by using a voltage divider, or for other experimental purposes.

The rectifier tube and socket are fitted on an angle bracket and fastened to the neon leakage indicator socket.

R. J. ANITA,
Mirzapur,
Ahmedabad (India)

HEADPHONES ADD TO POPULARITY OF PORTABLES

The easily-obtainable parts necessary for the adaptation of headphones to battery and battery-electric portables include a resistor, a condenser, and a telephone jack. Any standard 2,000- or 3,000-ohm headphones may be used.

The suggested method of installation permits operation with headphone or loudspeaker, or both together, depending on the degree to which the plug is inserted into

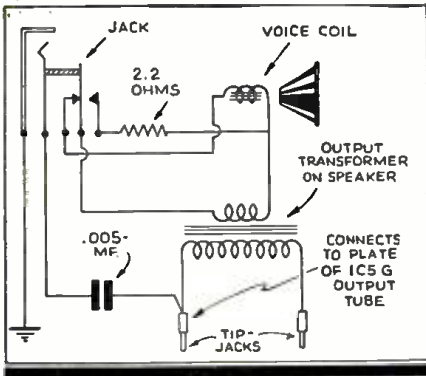

the jack. Partial insertion results in dual action, while pushing the plug all the way in disconnects the loudspeaker but leaves the headphones in operation. (A 2.2-ohm resistor is attached to automatically act as a dummy voice-coil load when the plug is inserted all the way.)

Taking the RCA Pick-Me-Up portables as an example, drill a 7/16-in. hole for the jack in the top of the cabinet at a point between the output tube and the batteries. At the top the cabinet is 7/16-in. in thickness, and it is necessary to chisel the inside of the cabinet (where the jack fits) to about 5/16-in. Otherwise the plug cannot be inserted all the way into the jack.

Make connections as shown in the diagram, leaving sufficient slack so that the batteries can be installed. Keep the leads grouped together and dressed away from the tubes.

LIST OF PARTS

- One RCA No. 1218 telephone jack;
- One RCA No. 30935 flexible-type resistor, 2.2 ohms;
- One RCA No. 4838 condenser, 0.005-mf.

Also one pair of radio headphones of standard "2,000-ohm" or "3,000-ohm" type, complete with plug.

RCA Radio Service News

USING "LOOP" PORTABLE IN CAR

Having purchased a portable receiver of the loop-antenna type I was confronted with the problem of getting it to operate in

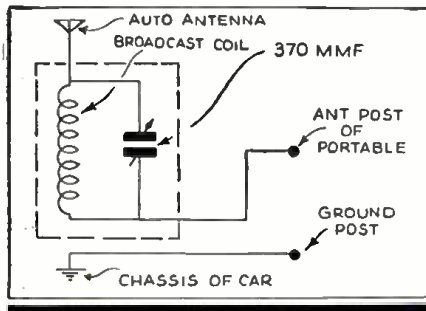

the car, since the all-steel body and turret top shielded all signal from the loop. Adding an auto antenna made it sufficiently sensitive to bring WJR (about 125 miles distant) in a little, though it was barely audible when connected directly to the set. When connected through the coupler described here the sensitivity was equal to that of the average home receiver. The size coil will depend on the set and antenna used and therefore must be obtained by experimentation (a standard B.C. plug-in coil was used in the original model).

To operate the set, tune the radio set to any desired station and adjust the control on this unit for maximum volume.

R. F. HOOPER,
Battle Creek, Mich.

LOCATES BREAKS IN LEADS

● HERE is a kink that I think might be useful to all Servicemen. It is very good for locating all broken line and resistance cords and not having to discard them unless the break is in such a place as to make resistance cords too short.

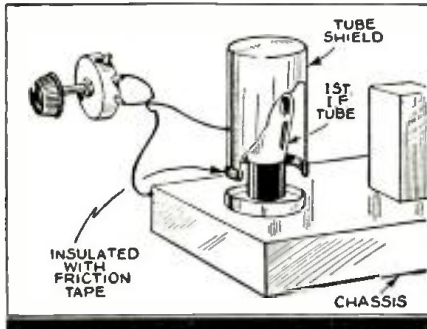

I have on the wall of my shop a 15,000-volt high-tension transformer connected through a switch to the 115-volt line; test leads and clips are fastened to the high-tension leads. When I have a broken wire of any kind that will not show continuity on an ohmmeter, I simply disconnect the wire completely from position in a set, appliance, etc., and connect the high-voltage test leads to it, throw the switch, and presto!, there is my broken connection, shown up by a puff of smoke. This operation is just a matter of seconds because if the connection is made for any length of time the wire insulation will burn. There is no danger attached to this if caution is exercised. This transformer is indispensable to our shop.

JAMES ALLEN,
Detroit, Mich.

FREE! VERY LATEST PROFIT GUIDE
Everything in RADIO!
At Lowest Prices!

COMPLETE SELECTIONS GUARANTEED QUALITY
Faster Delivery
Most complete stocks of Universal and Exact Duplicate Replacement and Repair Parts, Radio Sets, and Amateur Supplies.

P. A. EQUIPMENT
Separate amplifiers or complete systems with any desired assortment of speakers, horns, baffles and microphones. Everything from 5 to 100 watts. Prices that save money for you.

ELECTRICAL APPLIANCES
Extra profits for you! Standard Brand Electric Irons, Grills, Toasters, Percolators, Waffle Irons, Vacuum Cleaners, Clocks, Mixers, etc., at lowest prices.

MAIL THIS COUPON TODAY

The **RADOLEK Co.**
601 W. Randolph St., Chicago, Dept. C-46
Send the latest Radio Profit Guide **FREE**.

Name

Address Dealer?.....

Experimenter?..... Serviceman?..... Amateur?.....

COIL REPAIR & REWINDING SERVICE . . . by coil specialists

IF—OSC.—RF types—all kinds. Send in defective coils—monorel or standard makes—old or new. Save time and money—quick service—quality work—prompt call—give coil data if known—coil rewinding bulletin available—write. **QUALITY RADIO COILS OF ALL KINDS MADE TO ORDER** 1 or 1000—state your needs.

BARBER & HOWARD, Inc. East Avenue, Westbury, R. I.
Radio engineers and coil mfrs.

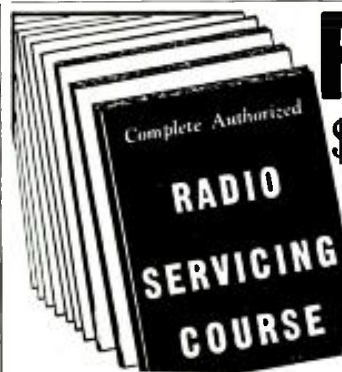

RADIO TRAINING

\$1.95 **AMAZING REDUCED PRICE**

This is your chance to get exact reprint of regular \$39.00 Radio Technical Institute course for only \$1.95, the full price. This is the latest Radio and Television Course, complete in every way, and exactly the same as the much higher priced original lessons.

EVERYTHING ABOUT RADIO

The training is remarkably complete. You quickly learn radio servicing from simple circuits to signal tracing. From the very start you are introduced to real radio methods and equipment. After finishing this course you will be able to expertly service every radio set. Take advantage of this unusual radio education bargain. Read all details and send coupon.



M. N. Seftman, radio engineer, author, instructor in Chicago schools, says: "Let Radio Tech. Institute course help you get ahead in Radio. I believe this is the biggest bargain in radio training!"

GOOD REVIEW COURSE FOR THOSE IN RADIO

Many active servicemen have found this reduced-price course excellent for brush up and study of new servicing methods. Reprinted in 1940, with added information on signal tracing, television, visual alignment, P.A. application, photo-cells, etc. Catch up with your radio education—get this bargain in complete radio training.

TELLS HOW TO USE INSTRUMENTS, SIGNAL TRACING, TELEVISION

Learn new speed-tricks of radio fault finding, servicing short-cuts, case histories of common troubles, extra profit ideas. Two large lessons on use of regular test equipment, explanation of signal tracing test methods, television to the minute, recording dope. With this information you will save enough time on one radio job to pay the special \$1.95 price for the complete course. If you are in radio work, you owe it to yourself to get this course and improve your knowledge.

● MONEY-BACK GUARANTEE ●

You must be satisfied or your money will be refunded immediately. References: Any magazine publisher or Liberty National Bank, Chicago.

LATEST DATA

Yes, the course will tell you about A.V.C., how to use an oscilloscope, what is feedback, resonance action, and every other fact you must know to be the best serviceman. Forty-three radio manufacturers helped to prepare this course. Just think what this backing by the radio industry means to you. This practical training gives you facts and real data you need on the job. Hundreds of diagrams and illustrations to help. One of the BEST radio courses is yours for only \$1.95, complete.

NEW LIMITED EDITION

Rush your order to us today. Only a small quantity of courses printed to sell at the reduced price. You are protected with our money-back guarantee. Begin studying this course this very week; act now.

FREE EXAMINATION COUPON

SUPREME PUBLICATIONS
3727 W. 13th St., Chicago, Illinois

Ship the complete Radio Course at the special reduced price. I must be pleased, or will get my money back.

I am enclosing \$1.95, send postpaid.

Ship C.O.D. I will pay postman \$1.95 and a few cents for postage.

Name:

Address: 135

•BOOK REVIEWS•

Typical Type -09
Hyvol Capacitor. 1
mfd. 1000 v. D.C.W.
3/8 x 1-13/16 x 1-1/16".
\$3.75 list.



Forget it!

• Yes, that's what you can do when you install an Aerovox HYVOL capacitor in your "rig." It's built for trouble-free service.

Hyvols are the No. 1 choice of many "hams" who build to last. Also with builders of fine commercial equipment. Oil-impregnated oil-filled. Sturdy metal cases. Pillar terminals. Adjustable mounting ring for upright or inverted mounting. 600 to 5000 v. D.C.W. 1 to 4 mfd. Popular prices.

Ask local jobber to show you HYVOL Xmitting capacitors. Ask for latest catalog. Or write us direct.



ELEMENTARY MATHEMATICS

• EASY — SIMPLIFIED — PRACTICAL •

HERE is a book for the business man, the technician and craftsman explaining and answering every operation and meaning with interpreting illustrations and examples.

It is the key to a simple understanding of many perplexing problems in daily life.

In clear, positive and definite language, the author popularizes and clarifies every subject and helps the reader to overcome any apparent difficulty in the study of mathematics.

A real home study-course in mathematics for the student or the man who wants to achieve proficiency or desires to brush-up on his knowledge.

Entire Chapter on Special Mathematics for the Radio Technician

CONTENTS OF BOOK

- CHAPTER I. Arithmetic—Addition—Subtraction—Multiplication—Division.
- CHAPTER II. Factoring and Cancellation—Fractions—Decimals—Percentage—Ratio—and Proportion.
- CHAPTER III. The Metric System.
- CHAPTER IV. How to Measure Surfaces and Capacity (Geometry).
- CHAPTER V. Powers and Involution—Roots and Evolution.
- CHAPTER VI. Mathematics for the Manual and Technical Craftsman—Thermometer conversions—Graphs or Curve Plotting—Logarithms—Use of the Slide Rule.
- CHAPTER VII. Special Mathematics for the Radio Technician.
- CHAPTER VIII. Commercial Calculations—Interests—Discounts—Short Cut Arithmetic.
- CHAPTER IX. Weights and Measures—Useful Tables.

"Elementary Mathematics" can be carried readily in your pocket. Send Stamps, Cash or Money Order.

TECHNIFAX

1917 S. State St. Chicago, Ill. RC-1040

PATENTS—TRADE MARKS

Booklet concerning Inventions & Patents Form "Evidence of Conception" with instructions for use and "Schedule of Government and Attorneys Fees"—Free

LANCASTER, ALLWINE & ROMMEL
Registered Patent Attorneys
436 Bowen Bldg. Washington, D. C.

PRINCIPLES OF TELEVISION ENGINEERING, by Donald G. Fink (1940). Published by McGraw-Hill Book Co., Inc. Size, 6 x 9 ins., cloth cover, 313 illustrations, 541 pgs. Price, \$5.

American practice in the design, construction and use of television transmitters and receivers is the backbone of this newest book by Mr. Fink, whose other technical books are well-known to many technicians.

The work of television specialists in other countries insofar as it is conveniently incorporated in this framework is discussed by the author. Briefly, "Principles" is a presentation (in logical sequence) for technicians of events taking place in television transmission and reception. Of interest is the fact that this book conforms to the standards of the R.M.A. Committee on Television. Prepared in textbook style, this volume is a "natural" for schools and libraries; further, it is recommended for the library of the ambitious technician.

BBC HANDBOOK 1940. Published by The British Broadcasting Corp., London, England. Size, 5 x 7 1/2 ins., cloth cover, profusely illustrated, 128 pgs. Price, 2 shillings.

A perennial favorite of the technician makes its debut in a 1940 edition. Its contents range from feature articles to reference sections.

Among the feature articles are those titled: Notes of the Year; "Au Revoir, Television"; Radio Documentary; Listening Post 1939; A War Diary; etc.

The reference section includes: Facts about the BBC; Some Notes on Reception; etc.

HANDBOOK OF HEARING AIDS, by A. F. Niemoeller (1940). Published by Harvest House. Size, 5 1/2 x 8 ins., cloth cover, 156 pgs. Price, \$3.

The rapidly-expanding field of aids for the hard-of-hearing now has found expression in a book devoted exclusively to this topic.

The table of contents is too extensive to reprint here. Briefly, its 31 chapters describe practically all the known types and leading brands of hearing aids; help the hard-of-hearing to select the proper type of appliance; and, explains how to use, test, and care for them. The first president for the New York League for the Hard of Hearing and later president for the American Society for the Hard of Hearing has written the Foreword.

UNDERSTANDING RADIO, by Herbert M. Watson, Herbert E. Welch and George S. Eby (1940). Published by McGraw-Hill Book Co., Inc. Size, 6 x 8 ins., cloth cover, 379 illustrations, plus photos; 603 pgs. Price, \$3.80.

The authors of this book have hit upon an excellent treatment of the elements of radio. Theoretical discussions in plain language are supplemented by analyses of practical circuits. The volume is prepared in textbook style and should receive wide acceptance in schools carrying radio courses.

Radio-Craft recommends this book to radio men who want to brush up on their grounding in the subject. A listing of the contents would convey little to the reader; the contents range from a pictorial analysis of wave motion straight through radio reception and transmission at all wavelengths. We commend to readers its 14th chapter, "Looking Ahead in Radio."

RCA HAM GUIDE (1940). Published by RCA Manufacturing Co., Inc., Commercial Engineering Section, Harrison, N. J. Also available from RCA transmitting tube distributors. Size 8 1/2 x 11 ins., over 70 illustrations and over 30 transmitting circuits, 48 pgs. Price, 15c.

The new RCA "Ham Guide" contains technical data on RCA's transmitting tubes for amateur use, approved circuits for utilizing them to best advantage, and useful data on the design and operation of ham stations. The book contains illustrated descriptions for building a 200-W. phone (450-W. C.W.) xmitter, and a 310-W. phone (450-W. C.W.) station, both jobs (on 10 to 160 meters) using type 812 as finals; 1st xmitter is cathode modulated, and the 2nd. plate modulated.

MOST POPULAR 1940 RADIO DIAGRAMS. Published by Supreme Publications. Size 8 1/2 x 11 ins., stiff paper cover, 212 pgs. Price, \$1.50.

This book contains the circuits of 417 models of 43 radio set manufacturers. This is claimed to represent over 80% of all the 1940 circuits Servicemen need. This book also includes service information, repair hints, alignment dope, and parts lists on new portables, television, frequency modulation, signal tracing, amplifiers, intercommunicators, recording, etc.

Index to advertisers

PUBLIC ADDRESS EQUIPMENT

Amplifier Co. of America229
John Meck Industries229
Miles Reproducer Co.231
Music Master Mfg. Co.229
RCA Mfg. Co., Inc.225
Recoton Corporation230
Universal Microphone Co., Ltd.229
University Laboratories231
Wright-DeCoster, Inc.229

PUBLISHERS

Data Print Co.246
McGraw-Hill Book Co., Inc.237
Miller, Wayne231
National Plans Inst.295
Radcraft Publications, Inc.198, 230
Radio & Technical Pub. Co.196
Rider, John F., Publisher, Inc.203
Supreme Publications212, 255
Technifax246, 256

RADIO PARTS

Aerovox Corporation256
Amperite Co.211
Hammarlund Mfg. Co.228
Solar Mfg. Corp.215
Sprague Products Co.212

RADIO SETS

Goldentone Radio Co.215
Halicrafters, Inc.Back Cover
Howard Radio Co.241
Meissner Mfg. Co.241
Midwest Radio Corp.Inside Back Cover
Pilot Radio Corporation203
E. H. Scott Radio Lab., Inc.197

RADIO SUPPLY HOUSES

Allied Radio Corp.231
Anchor Radio Distributing Service195
Burstein-Applebee Co.247
Hudson Specialties Co.248
Lafayette Radio Corp.209
Radolek Co.255

SCHOOLS

Capitol Radio Eng. Inst.195
Lincoln Engineering School195
National Radio Institute193
National Schools195
New York Y.M.C.A. Schools195
Radio Training Assoc.195
RCA Institutes195
Sprayberry Academy of Radio195

TEST EQUIPMENT

Radio City Products Co.219
Readrite Meter Works212
Stuart, Allan254
Superior Instruments Co.211, 213, 215, 217
Supreme Instruments Corp.223
Triplett Electrical Instrument Co.210

TUBES

Hygrade Sylvania Corp.233
National Union Radio Corp.224

MISCELLANEOUS

Barber & Howard255
Classified Section237
Lancaster, Allwine & Rommel256
Radio Servicemen of America244
Remington Rand, Inc.236
Woodstock Typewriter Co.229

(While every precaution is taken to insure accuracy, we cannot guarantee against the possibility of an occasional change or omission in the preparation of this index.)

WHERE CAN YOU EQUAL THIS 1941 RADIO FOR ONLY \$

19.95

MIDWEST

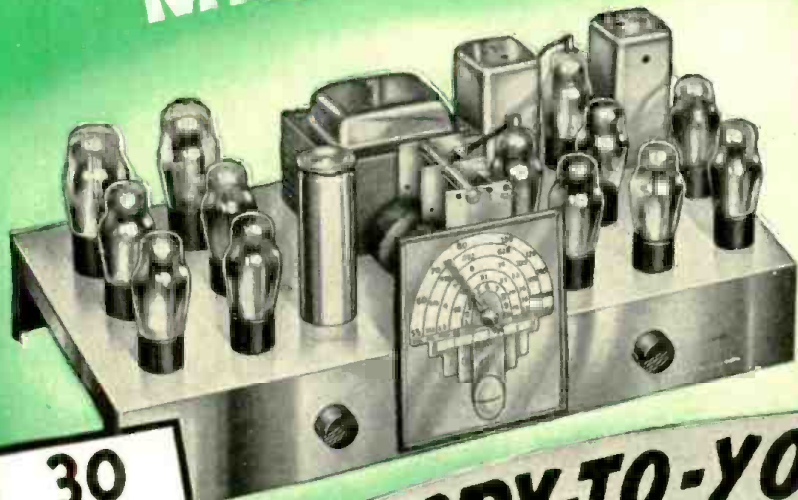

MIDWEST

14-TUBE CHASSIS*

COMPLETE WITH TUBES AND SPEAKER READY TO INSTALL IN YOUR PRESENT CABINET

30 DAYS TRIAL • EASY TERMS

FACTORY-TO-YOU SAVES UP TO 50%

FREQUENCY MODULATION AND TELEVISION PROVISION

Now, you can enjoy the mighty power of a 14-Tube* radio, at the amazingly low, factory-to-you price of only \$19.95.

You never heard such brilliant performance and beautiful tone for so little money! Now, tune in exciting broadcasts direct from distant overseas stations. Our famous 30-day prove-it-yourself plan, fully protects you and enables you to prove Midwest's super performance in the privacy of your own home, without obligation.

YOU BE THE JUDGE

Do like thousands have done—put this new 1941 chassis in your present cabinet. Other chassis and cabinet models are fully pictured and described in our new 1941 Factory-To-You, money-saving catalog... from 5 to 17 Tubes, and up to 5-Wave Bands... including Radio-Phonograph combinations and Home Recorders.

AMAZING FOREIGN RECEPTION

Tune in broadcasts direct from the capitals of Europe. Listen direct to distant overseas stations in remotest parts of the globe. Hear history in the making before it appears in your local paper, and, before your local station announces its own version of the news!

*Fourteen tubes include Rectifiers, Control and Tuning Eye Tubes.



14-TUBE CABINET MODEL

\$ 29.95 COMPLETE

FILL IN COUPON AND MAIL TODAY OR JUST SEND YOUR NAME AND ADDRESS ON A POSTCARD

MIDWEST *factory-to-you* RADIOS

MANUFACTURERS OF QUALITY RADIOS SINCE 1920

Midwest Radio Corporation
Cincinnati, Ohio, U. S. A.
Dept. 12-BB

Send me your new FREE Catalog, complete details of your liberal 30-day Trial offer and factory-to-you prices.

Name.....

Address.....

Town..... State.....

User-Agents Make Easy Extra Money. Check here () for details.

FREE RADIO CATALOG

GET MIDWEST'S ANSWER TO TRADE-INS!

New DIRECTION FINDER

Model S-30 Radio Compass and Direction Finder covers from 200 to 3000 kc (1500 to 100 meters) on 3 bands—Beacon, Broadcast and Marine. Has provision for external speaker. Welded aluminum cabinet houses the receiver and supports the rotatable 12-inch loop antenna. Power supply in separate cabinet. Operates from 6 volts. \$99.50 NET



the hallicrafters inc.
CHICAGO, U. S. A.

USED BY 33 GOVERNMENTS • SOLD IN 89 COUNTRIES



New PORTABLE COMMUNICATIONS RECEIVER

Model S-29 Sky Traveler operates on 110 volt AC or DC or from self-contained batteries. Covers from 542 kc to 30.5 mc (553 to 9.85 meters) on 4 bands. Built-in collapsible antenna extends to 3 feet. Battery life prolonged through self-contained charging circuit. Automatic noise limiter, electrical bandspread, built-in speaker, etc. \$59.50 NET